



INSTRUCTION MANUAL

FM TRANSCEIVER

IC-2300H



This device complies with Part 15 of the FCC Rules. Operation is subject to the following two conditions: (1) this device may not cause harmful interference, and (2) this device must accept any interference received, including interference that may cause undesired operation.

FOREWORD

Thank you for purchasing this Icom radio. The IC-2300H FM TRANSCEIVER is designed and built with Icom's state of the art technology and craftsmanship. With proper care this radio should provide you with years of trouble-free operation.

◆ FEATURES

- 65 W* — high transmit output power
(*except Korea/Taiwan versions)
- Tone squelch, DTCS squelch standard
- Three color (amber, yellow & green) back-light LCD screen
- Remote control microphone available

IMPORTANT

READ ALL INSTRUCTIONS carefully and completely before using the transceiver.

SAVE THIS INSTRUCTION MANUAL— This instruction manual contains important operating instructions for the IC-2300H.

EXPLICIT DEFINITIONS

WORD	DEFINITION
⚠ WARNING!	Personal injury, fire hazard or electric shock may occur.
CAUTION	Equipment damage may occur.
NOTE	Recommended, only inconvenience. No risk of personal injury, fire or electric shock.

Icom, Icom Inc. and the Icom logo are registered trademarks of Icom Incorporated (Japan) in Japan, the United States, the United Kingdom, Germany, France, Spain, Russia and/or other countries.

SUPPLIED ACCESSORIES

- ① Microphone (HM-133V) 1
- ② Fuse (20 A) 1
- ③ DC power cable (3 m) 1
- ④ Mobile mounting bracket 1
- ⑤ Mounting screws, nuts and washers 1 set
- ⑥ Microphone hanger[†] 1

[†]Not supplied, depending on the version.

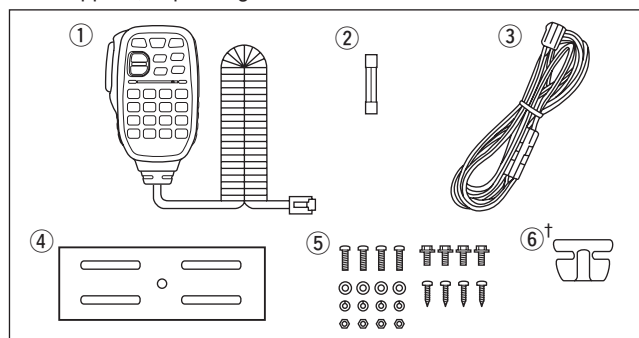

OPTIONS

- HM-133V** REMOTE-CONTROL MICROPHONE
- HM-154** HAND MICROPHONE
- SP-10** EXTERNAL SPEAKER
- OPC-440A** MIC EXTENSION CABLE
- OPC-589** ADAPTER CABLE
- OPC-1132A/OPC-347** DC POWER CABLES
- CS-2300H** CLONING SOFTWARE
- OPC-478/OPC-478UC** CLONING CABLES
- OPC-474** CLONING CABLE

FCC INFORMATION

• FOR CLASS B UNINTENTIONAL RADIATORS:

This equipment has been tested and found to comply with the limits for a Class B digital device, pursuant to part 15 of the FCC Rules. These limits are designed to provide reasonable protection against harmful interference in a residential installation. This equipment generates, uses and can radiate radio frequency energy and, if not installed and used in accordance with the instructions, may cause harmful interference to radio communications. However, there is no guarantee that interference will not occur in a particular installation. If this equipment does cause harmful interference to radio or television reception, which can be determined by turning the equipment off and on, the user is encouraged to try to correct the interference by one or more of the following measures:

- Reorient or relocate the receiving antenna.
- Increase the separation between the equipment and receiver.
- Connect the equipment into an outlet on a circuit different from that to which the receiver is connected.
- Consult the dealer or an experienced radio/TV technician for help.

PRECAUTIONS

⚠ WARNING RF EXPOSURE! This device emits RadioFrequency (RF) energy. Extreme caution should be observed when operating this device. If you have any questions regarding RF exposure and safety standards, please refer to the Federal Communications Commission Office of Engineering and Technology's report on Evaluating Compliance with FCC Guidelines for Human Radio frequency Electromagnetic Fields (OET Bulletin 65).

⚠ WARNING! NEVER connect the transceiver to an AC outlet. This may pose a fire hazard or result in an electric shock.

⚠ WARNING! NEVER cut the DC power cable between the DC plug and fuse holder. If an incorrect connection is made after cutting, the transceiver may be damaged.

⚠ WARNING! NEVER operate the transceiver while driving a vehicle. Safe driving requires your full attention—anything less may result in an accident.

⚠ WARNING! NEVER connect the transceiver to a power source of more than 16 V DC or use reverse polarity. This could cause a fire or damage the transceiver.

⚠ WARNING! NEVER operate or touch the transceiver with wet hands. This may result in an electric shock or damage the transceiver.

⚠ WARNING! NEVER place the transceiver where normal operation of the vehicle may be hindered or where it could cause bodily injury.

⚠ WARNING! NEVER let metal, wire or other objects touch any internal part of the transceiver. This may result in an electric shock.

CAUTION: NEVER expose the transceiver to rain, snow or any liquids. The transceiver may be damaged.

DO NOT push the PTT when not actually intending to transmit.

KEEP the transceiver out of the reach of children.

During mobile operation, **DO NOT** operate the transceiver without running the vehicle's engine. When the transceiver's power is ON and your vehicle's engine is OFF, the vehicle's battery will soon become exhausted.

BE CAREFUL! The transceiver will become hot when operating it continuously for long periods of time.

DO NOT set the transceiver in a place without adequate ventilation. Heat dissipation may be affected, and the transceiver may be damaged.

DO NOT use or place the transceiver in direct sunlight or in areas with temperatures below -10°C ($+14^{\circ}\text{F}$) or above $+60^{\circ}\text{C}$ ($+140^{\circ}\text{F}$).

DO NOT use harsh solvents such as benzine or alcohol when cleaning, as they will damage the transceiver's surfaces.

USE only Icom microphones (supplied or optional). Other manufacturer's microphones have different pin assignments and may damage the transceiver if attached.

Approved Icom optional equipment is designed for optimal performance when used with an Icom transceiver.

Icom is not responsible for the destruction or damage to an Icom transceiver in the event the Icom transceiver is used with equipment that is not manufactured or approved by Icom.

For only U.S.A.

CAUTION: Changes or modifications to this device, not expressly approved by Icom Inc., could void your authority to operate this device under FCC regulations.

TABLE OF CONTENTS

FOREWORD	i	10 POCKET BEEP AND TONE SQUELCH	39–42
IMPORTANT	i	■ Pocket beep operation	39
EXPLICIT DEFINITIONS	i	■ Tone/DTCS squelch operation	41
SUPPLIED ACCESSORIES	i	■ Tone scan	42
OPTIONS	i	11 OTHER FUNCTIONS	43–53
FCC INFORMATION	i	■ Set mode	43
PRECAUTION	ii	■ Initial Set mode	47
TABLE OF CONTENTS	iii	■ Weather channel operation	50
QUICK REFERENCE GUIDE	IV–VII	■ Microphone keys	51
■ Installation	iv	■ Partial reset	52
■ Your first contact	vi	■ All reset	52
■ Repeater operation	vi	■ Data cloning	53
■ Programming memory channels	vii	12 SPECIFICATIONS	54
1 PANEL DESCRIPTION	1–4	13 MAINTENANCE	55
■ Front panel	1	■ Troubleshooting	55
■ Function display	2	■ Fuse replacement	55
■ Rear panel	3		
■ Microphone (HM-133V)	3		
■ Microphone keypad	4		
2 SETTING A FREQUENCY	5–7		
■ Preparation	5		
■ Using the tuning dial	5		
■ Using the keypad	5		
■ Using the [▲] or [▼] keys	5		
■ Tuning step selection	6		
■ Lock functions	7		
3 BASIC OPERATION	8–14		
■ Receiving	8		
■ Monitor function	8		
■ Audio mute function	9		
■ Squelch attenuator	9		
■ S-meter squelch	9		
■ Transmitting	10		
■ Selecting output power	11		
■ One-touch PTT function	11		
■ Accessing a repeater	12		
■ Subaudible tones	13		
4 REPEATER SETTING	15–16		
■ Frequency offset	15		
■ Repeater lockout	15		
■ Reversed duplex function	16		
■ Auto repeater	16		
5 MEMORY OPERATION	17–26		
■ General description	17		
■ Programming a memory channel	17		
■ Memory channel selection	18		
■ Copying memory contents	19		
■ Programming channel names	21		
■ Memory clearing	22		
■ Memory bank setting	23		
■ Memory bank selection	24		
■ Transferring bank links	25		
■ Erasing bank links	26		
6 CALL CHANNEL OPERATION	27–28		
■ Call channel selection	27		
■ Copying Call channel contents	27		
■ Programming a Call channel	28		
7 SCAN OPERATION	29–33		
■ Scan types	29		
■ Scan start/stop	30		
■ Scan edges programming	31		
■ Skip channel setting	32		
■ Scan Resume function	33		
8 PRIORITY WATCH	34–35		
■ Priority watch types	34		
■ Priority watch operation	35		
9 DTMF MEMORY ENCODER	36–38		
■ Programming a DTMF code	36		
■ Transmitting a DTMF code	37		
■ DTMF TX speed	38		

1
2
3
4
5
6
7
8
9
10
11
12
13

QUICK REFERENCE GUIDE

Installation

Location

Select a location which can support the weight of the transceiver and does not interfere with driving in any way. We recommend the locations shown in the diagram below.

WARNING! NEVER place the transceiver where normal operation of the vehicle may be hindered or where it could cause bodily injury.

WARNING! NEVER place the transceiver where air bag deployment may be obstructed.

DO NOT place the transceiver where hot or cold air blows directly onto it.

DO NOT place the transceiver in direct sunlight.

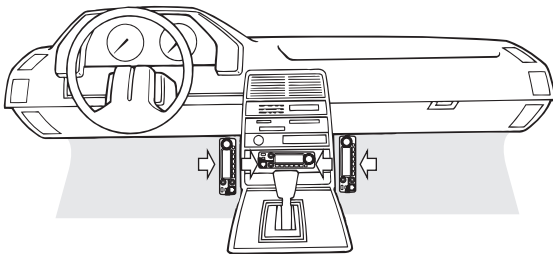

Using the mounting bracket

- ① Drill 4 holes where the mounting bracket is to be installed.
 - Approx. 5.5–6 mm (0.25 inch) when using nuts; approximately 2–3 mm (0.13 inch) when using self-tapping screws.
- ② Insert the supplied screws, nuts and washers through the mounting bracket and tighten.
- ③ Adjust the angle for the clearest view of the function display.

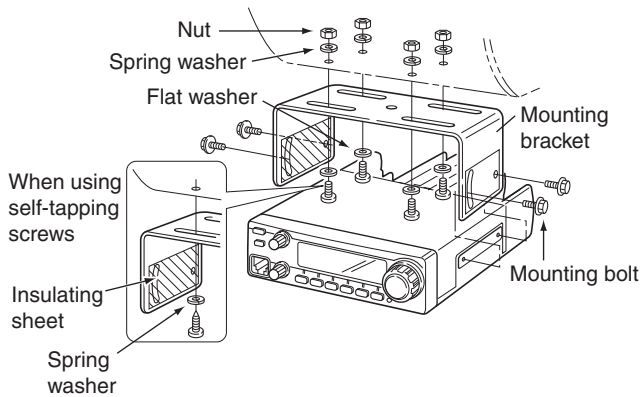

IMPORTANT!

Detailed installation notes for Icom mobile transceivers are available. Contact your Icom dealer or distributor.

Battery connection

WARNING! NEVER connect the transceiver directly to a 24 V battery.

DO NOT use the cigarette lighter socket for a power connection.

When passing the DC power cable through metal material, use a rubber grommet to prevent short circuiting.

CONNECTING TO A DC POWER SUPPLY

(See page 55 for fuse replacement.)

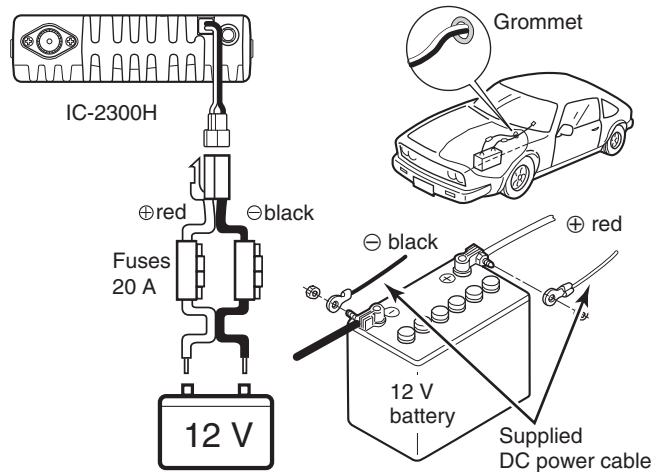

NOTE:

Use terminals for the cable connections.



DC power supply connection

Use a 13.8 V DC power supply with a capacity of at least 20 Amps.

Make sure the **ground** terminal of the DC power supply is connected to a secure earth.

CONNECTING TO A DC POWER SOURCE

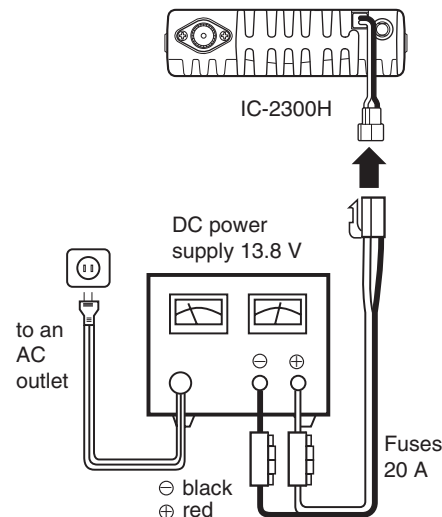

(See page 55 for fuse replacement.)

◇ **Antenna installation**

• Antenna location

To obtain maximum performance from the transceiver, select a high-quality antenna and mount it in a good location. When you use a magnetic mount, use a non-radial antenna.

Roof-mount antenna

(Drill a hole or use a magnetic mount.)

Gutter-mount antenna

Trunk-mount antenna

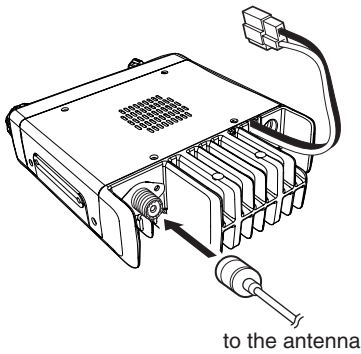
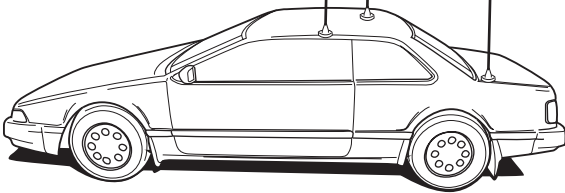

• **Installing the antenna connector**

The antenna uses a PL-259 connector.

• PL-259 CONNECTOR

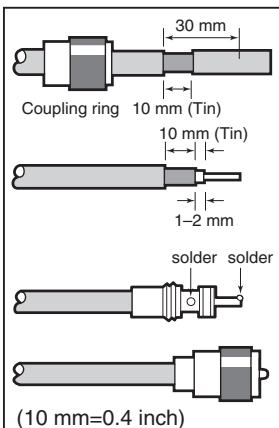

- ① Slide the coupling ring down. Strip the cable jacket and tin the ground shield.
- ② Strip the cable as shown at left. Tin the center conductor.
- ③ Slide the connector body on and solder it.
- ④ Screw the coupling ring onto the connector body.

/// **NOTE:** There are many publications covering proper antennas and their installation. Check with your local dealer for more information and recommendations.

◇ **Connecting the microphone**

Connect the microphone to the eight-pin modular socket on the front panel of the transceiver.

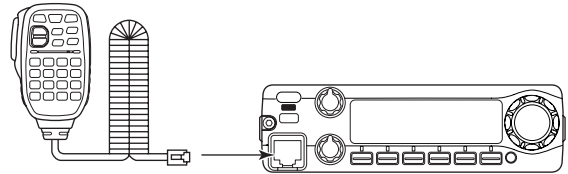

QUICK REFERENCE GUIDE

■ Your first contact

Now that you have your IC-2300H installed in your car or shack, you are probably excited to get on the air. We would like to take you through a few basic operation steps.

1. Turning ON the transceiver

Before turning ON your IC-2300H, make sure the audio volume and squelch level controls are set to 9–10 o'clock.

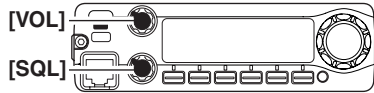

Set both [VOL] and [SQL] to the 9–10 o'clock position.

Although you have purchased a brand new transceiver, some settings may have changed from the factory defaults because of the QC process. The Partial Rest is recommended to start with factory default settings.

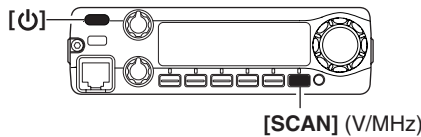

➔ While holding down [V/MHz], hold down [P] for 1 second to reset the CPU.

2. Tune the desired frequency

[DIAL] will allow you to set the frequency you want to operate on. Page 6 explains how to set the tuning speed.

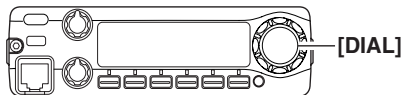

Using the HM-133V

You can directly enter the frequency with the HM-133V keypad.

[i.e.]: Setting the frequency to 145.3625 MHz.

Push **VFO/LOCK** → 145.600

Push **T-OFF ENT C** → 145.36

Push **ANM MONI 1**, **DTCS HIGH 4**, **DTCS MID 5**, **PTT-M PRIO 3**, **DTMF LOW 6** → 145.3625

Push **T-SCAN SCAN 2** → 145.3625

■ Repeater operation

1. Setting duplex

Hold down [DUP] (LOW) for 1 second one or more times to select minus duplex or plus duplex.

• The USA version has an Auto Repeater function, therefore, setting duplex is not required.

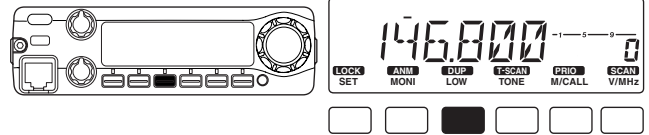

2. Repeater tone

If accessing the repeater, requires a subaudible tone, push [TONE] one or more times until “♪” appears.

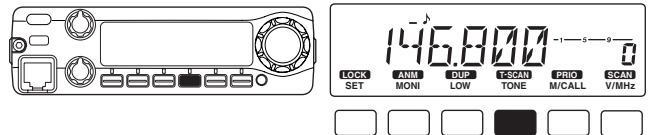

Using the HM-133V

Plus or minus duplex selection and the repeater tone setting can easily be made using the HM-133V.

Push [DUP-] for minus duplex; [DUP+] for plus duplex selection, then push [FUNC] (FUNC), and then [DUP-] to turn ON the repeater tone.

Push **TSQLE+ DUP+ 8** → 146.8000

Push **FUNC**, then **TSQLE+ DUP+ 8** → 146.8000

Push **TONE DUP- 7** → 146.8000

■ Programming memory channels

The IC-2300H has a total of 207 memory channels for storing often used operating frequencies, repeater settings, and so on. Memories include 6 scan edges and 1 Call channel.

1. Setting the frequency

In the **VFO** mode, set the desired operating frequency, repeater, tone and tuning steps, and so on.

2. Selecting the memory channel

Push **[S.MW]**, and then rotate **[DIAL]** to select the desired memory channel.

- The “**M**” icon and memory channel number blink.

3. Writing a memory channel

Hold down **[MW]** (S.MW) for 1 second to program.

- 3 beeps sound
- The memory channel number automatically increases when continuing to hold down **[MW]** (S.MW) after programming.

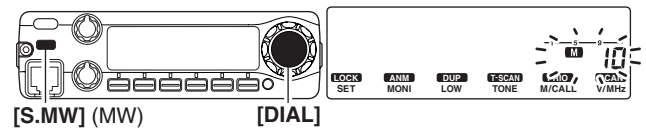

Using the HM-133V

- ① In the VFO mode, set the desired operating frequency, offset and direction, tone settings, and so on.
- ② Push **[FUNC]** ^{FUNC} then **[MW]** ^{MW CLR A}.
 - The “**M**” icon and memory channel number blink.
- ③ Push **[▲]** or **[▼]** to select the desired memory channel.
- ④ Push **[FUNC]** ^{FUNC} then hold down **[MW]** ^{MW CLR A} for 1 second to save the setting.
 - 3 beeps sound
 - The memory channel number automatically increases when you continuing to hold down **[MW]** ^{MW CLR A} after programming.

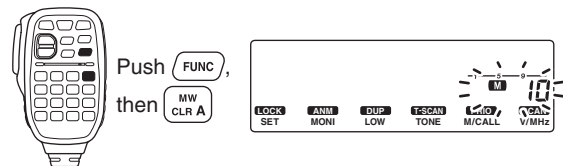

Front panel

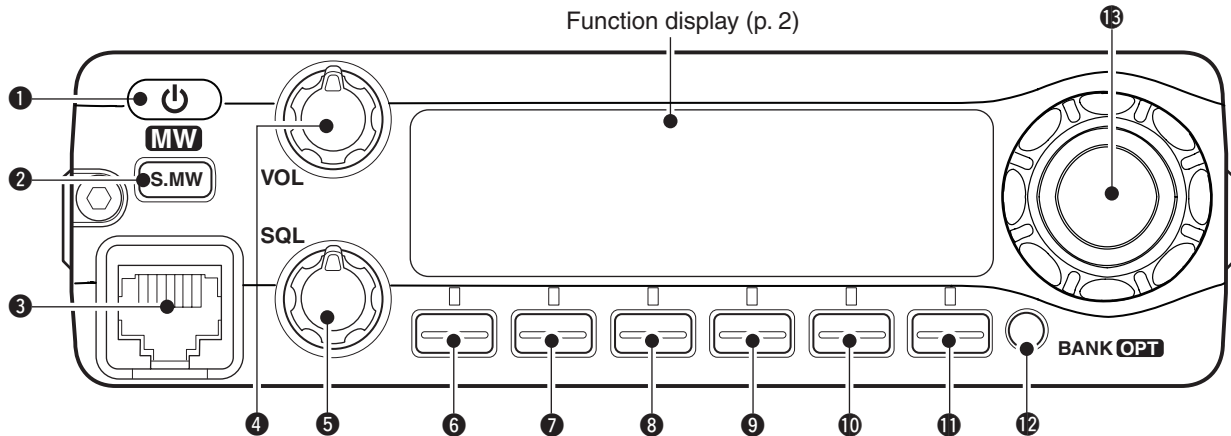

1 POWER KEY [⏻]

Hold down for 1 second to turn power ON or OFF.

2 MEMORY WRITE KEY [S.MW MW] (p. 17)

- ➔ Push to enter the memory write mode.
- ➔ Hold down for 1 second to program a selected memory channel.
 - Continue to hold down the key to automatically increment the memory channels.

3 MICROPHONE CONNECTOR

Connect the supplied microphone here.

4 VOLUME CONTROL [VOL] (p. 8)

Rotate to adjust the audio level.

5 SQUELCH CONTROL [SQL] (p. 8)

Rotate to adjust the squelch level.

- The S-meter squelch or attenuator squelch is activated, when you rotate [SQL] clockwise from the center position. (p. 9)

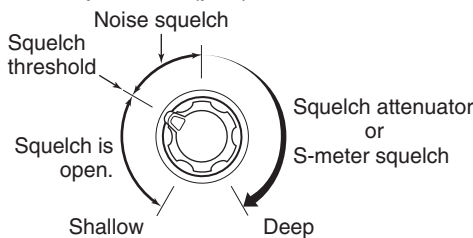

6 SET-LOCK KEY [SET LOCK]

- ➔ Push to enter to the **Set mode**. (p. 43)
- ➔ Hold down for 1 second to turn the Lock function ON or OFF. (p. 7)

7 MONITOR-CHANNEL NAME KEY [MONI ANM]

- ➔ Push to turn the monitor function ON or OFF. (p. 8)
- ➔ In the memory or Call channel mode, hold down for 1 second to turn the channel names or number ON or OFF. (p. 21)

8 OUTPUT POWER-DUPLEX KEY [LOW DUP]

- ➔ Push to select the output power. (p. 11)
- ➔ Hold down for 1 second to select the minus **duplex**, plus duplex or **simplex** mode. (p. 12)

9 TONE-TONE SCAN KEY [TONE T-SCAN]

- ➔ Push to select the tone function. (pp. 39, 41)
- ➔ Hold down for 1 second to start the Tone Scan. (p. 42)

10 MEMORY/CALL-PRIORITY KEY [M/CALL PRIO]

- ➔ Push to select and toggle memory, Call and weather channel* modes. (pp. 18, 27, 50)
- *For only USA versions.
- ➔ Hold down for 1 second to start the **priority watch**. (p. 34)

11 VFO/MHz TUNING-SCAN KEY [V/MHz SCAN]

- ➔ Push to select the **VFO** mode. (p. 5)
 - In the VFO mode, push to select the tuning step. (p. 5)
- ➔ Hold down for 1 second to start a **scan**. (p. 29)
 - Push to cancel the scan while scanning.

12 BANK-OPTION KEY [BANK OPT]

- ➔ Push to select the **memory bank** while in the memory mode. (p. 23)
- ➔ Hold down for 1 second to enter the Option Set mode. (p. 36)

13 TUNING DIAL [DIAL]

- ➔ Sets the operating frequency (p. 5), memory channel. (p. 18)
- ➔ Sets the item in the Set mode. (p. 43)
- ➔ Changes the scanning direction. (p. 30)

◇ Microphone connector (front panel view)

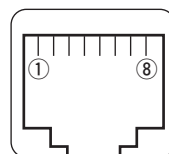

- ① +8 V DC output (Max. 35 mA)
- ② Channel up/down
- ③ 8 V control IN
- ④ PTT
- ⑤ GND (microphone ground)
- ⑥ MIC (microphone input)
- ⑦ GND
- ⑧ Data IN

■ Function display

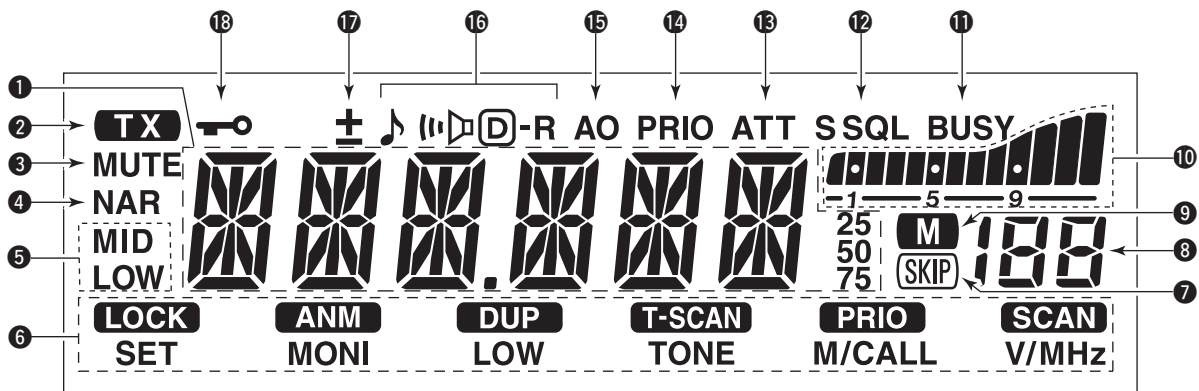

1 FREQUENCY READOUT

Shows the operating frequency, channel name, **Set mode** contents, and so on.

- The frequency decimal point blinks during a **scan**. (p. 30)
- While the **DTMF** memory function is in use, “d” appears in the 100 MHz digit. (p. 36)

2 TRANSMIT ICON

- ➔ Appears while transmitting. (p. 10)
- ➔ Blinks while transmitting with the One-Touch PTT function. (p. 11)

3 AUDIO MUTE ICON (p. 9)

Appears when the Audio Mute function is activated.

4 NARROW MODE ICON (p. 43)

Appears when the narrow **FM** mode is selected.

5 OUTPUT POWER ICONS (p. 11)

- Displays the selected transmit output power level.
- The “Mid-Low” power is not selectable in the Taiwan version.

6 KEY ICONS

Displays the function(s) of the front panel keys directly below the function display.

7 SKIP ICON (p. 32)

Appears when the selected memory channel is set as a skip channel.

8 MEMORY CHANNEL NUMBER READOUT

- ➔ Displays the selected memory channel number. (p. 18)
- ➔ “C” appears when the Call channel is selected. (p. 27)

9 MEMORY ICON (p. 17)

Appears when the Memory mode is selected.

10 S/RF INDICATOR

- ➔ Shows the relative signal strength, while receiving signals. (p. 8)
- ➔ Shows the output power level, while transmitting. (p. 10)

11 BUSY ICON (p. 8)

- ➔ Appears when receiving a signal, or the squelch is open.
- ➔ Blinks while the monitor function is turned ON.

12 S-METER SQUELCH ICON (p. 9)

Appears while the S-meter Squelch function is turned ON.

13 SQUELCH ATTENUATOR ICON (p. 9)

Appears while the Squelch Attenuator function is turned ON.

14 PRIORITY WATCH ICON (p. 35)

Appears during **Priority Watch**.

15 AUTO POWER OFF ICON (p. 47)

Appears when the Auto Power OFF function is turned ON.

16 TONE ICONS

- ➔ The “♪” and “D” icons appear while the subaudible tone encoder is in use. (p. 13)
- ➔ The “♪” and “@” icons appear while the **DTCS** encoder is in use. (p. 13)
- ➔ The “D” icon appears while the **Tone Squelch (CTCSS)** function is in use. (p. 41)
- ➔ The “D” and “-R” icons appear while the Reverse Tone Squelch (CTCSS) function is in use. (p. 41)
- ➔ The “@” icon appears while the Tone Squelch (DTCS) function is in use. (p. 41)
- ➔ The “@” and “-R” icons appear while the Reverse Tone Squelch (DTCS) function is in use. (p. 41)
- ➔ The “!” icon appears with the “D” or “@” icon, while the **pocket beep** function (CTCSS or DTCS) is in use. (p. 39)

17 DUPLEX ICONS (p. 12)

The “+” icon appears in the plus **duplex** mode, and the “-” icon appears in the minus duplex mode.

18 LOCK ICON (p. 7)

Appears while the Lock function is turned ON.

1 PANEL DESCRIPTION

■ Rear panel

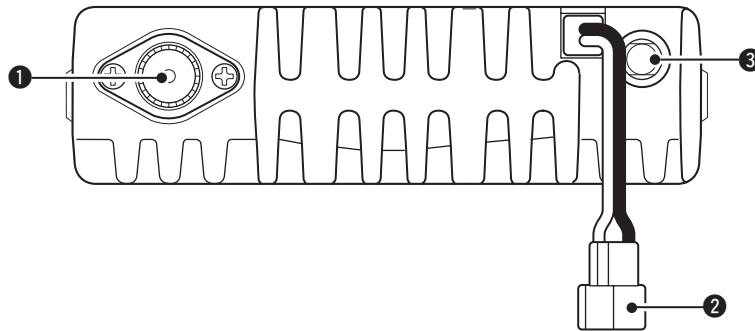

1 ANTENNA CONNECTOR [ANT]

Connect a 50 Ω antenna with a PL-259 connector, through a 50 Ω coaxial cable.

2 POWER RECEPTACLE [DC13.8V]

Connect a 13.8 V **DC** ±15% power source with the supplied DC power cable.

NOTE: DO NOT use a cigarette lighter socket as a power source, when operating in a vehicle. The plug may cause voltage drops and ignition noise may be superimposed onto the transmit or receive audio.

3 SPEAKER JACK [SP]

Connect a 4 Ω speaker here.

- Audio output power is more than 3.5 W.

■ Microphone (HM-133V)

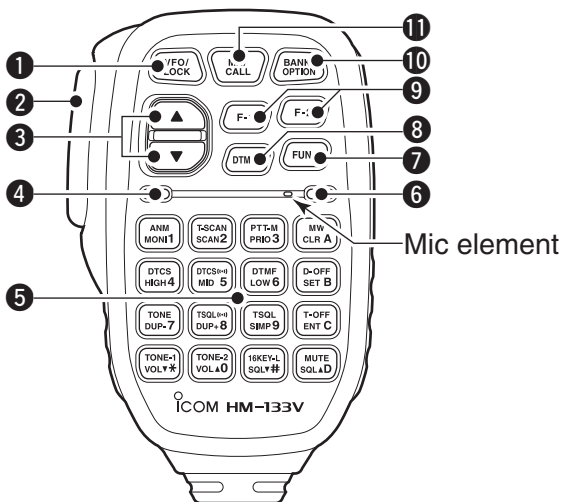

1 VFO/LOCK KEY [VFO/LOCK]

- ➔ Push to select the VFO mode. (p. 5)
- ➔ Hold down for 1 second to turn the Lock function ON or OFF. (p. 7)

2 PTT SWITCH

- ➔ Hold down to transmit; release to receive.
- ➔ Toggles between transmitting and receiving while the One-Touch PTT function is in use. (p. 11)

3 UP/DOWN KEYS [▲] or [▼]

- ➔ Push either key to change the operating frequency, memory channel, mode setting, and so on. (pp. 5, 18, 43)
- ➔ Hold down either key for 1 second to start scanning. (p. 30)

4 ACTIVITY INDICATOR

- ➔ Lights red while any key, except [FUNC] **FUNC** and [DTMF-S] **DTMF-S**, is pushed, or while transmitting.
- ➔ Lights orange while the Microphone Keypad Lock function is activated.
- ➔ Lights green while the One-Touch PTT function is in use.

5 KEYPAD (p. 4)

- ➔ Push to activate various functions.

6 FUNCTION INDICATOR

- ➔ Lights orange while [FUNC] **FUNC** is activated—indicating the secondary function of keys can be accessed.
- ➔ Lights green when [DTMF-S] **DTMF-S** is activated—**DTMF** signals can be transmitted using the keypad.

7 FUNCTION KEY [FUNC] (p. 4)

8 DTMF MEMORY SELECT KEY [DTMF-S] (p. 37)

9 FUNCTION KEYS [F-1] or [F-2] (p. 51)

Program and re-call your desired transceiver setting.



















10 BANK/OPTION KEY [BANK/OPTION]

- ➔ Push to select the **memory bank** option, when in the memory mode. (p. 24)
- ➔ Hold down for 1 second to enter the Option Set mode.

11 MEMORY/CALL KEY [MR/CALL]

- ➔ Push to select the memory mode. (p. 18)
- ➔ Hold down for 1 second to select the Call channel. (p. 27)

■ Microphone keypad

KEY	FUNCTION	SECONDARY FUNCTION ( +key)	OTHER FUNCTION
	Opens and closes the squelch. (p. 8)	Turns the channel names or number display ON or OFF, in the memory mode. (p. 21)	After pushing [DTMF-S]  , transmits the appropriate DTMF code. (pp. 14, 37) When the DTMF memory encoder is activated, push [A] to [D] , [*] , [#] , [0] to [9] , to transmit the appropriate DTMF memory contents. (p. 37)
	Starts and stops scanning . (p. 30)	Starts and stops tone scanning. (p. 42)	
	Starts and stops priority watch . (p. 35)	Turns the One-Touch PTT function ON or OFF. (p. 11)	
	Selects high output power. (p. 11)	Turns ON the DTCS squelch. (p. 41)	
	Selects mid output power. (p. 11)	Turns ON the DTCS pocket beep function. (p. 39)	
	Selects low output power. (p. 11)	Turns ON the DTMF memory encoder function. (p. 37)	
	Selects the minus duplex mode. (p. 12)	Turns ON the subaudible tone encoder. (p. 13)	
	Selects the plus duplex mode. (p. 12)	Turns ON the CTCSS pocket beep function. (p. 39)	
	Selects the simplex mode. (p. 12)	Turns ON the Tone Squelch function. (p. 41)	
	Adjusts the audio level. (p. 8)	Sends a 1750 Hz tone signal while held down. (p. 14)	
	<ul style="list-style-type: none"> ➔ Cancels frequency entry. (p. 5) ➔ Cancels the scan or priority watch. (pp. 30, 35) ➔ Exit the Set mode. (p. 43) 	<ul style="list-style-type: none"> ➔ Selects a memory channel programming mode. (p. 17) ➔ Advances the memory channel number when continuously held down after programming is completed. (p. 17) 	
	<ul style="list-style-type: none"> ➔ Enters the Set mode. (p. 43) ➔ Selects the next item in the Set mode. (p. 43) 	Turns OFF the DTMF memory mode. (p. 37)	
	<ul style="list-style-type: none"> ➔ Sets the keypad for numeral input. (p. 5) ➔ Selects the previous item in the Set mode. (p. 43) 	Turns OFF the subaudible tone encoder, pocket beep or CTCSS/DTCS tone squelch. (pp. 13, 39, 41)	
	Adjusts the squelch level. (p. 8)	Mutes the audio. (p. 9) • The Mute function is released when any operation is performed.	
	Adjusts the audio level. (p. 8)	Sends a 1750 Hz tone signal for 1 second. (p. 14)	
	Adjusts the squelch level. (p. 8)	Locks the digit keys on the keypad (including the [A] to [D] , [#] and [*] keys). (p. 7) • Lights orange while the Microphone Keypad Lock function is activated.	

■ Preparation

◇ Turning power ON/OFF

- ➔ Hold down [P] for 1 second to turn the power ON or OFF.

◇ VFO mode selection

The IC-2300H has 2 basic operating modes; **VFO** mode and memory mode.

- ➔ Push [V/MHz] to select the VFO mode.
 - Push [M/CALL] to select the memory mode.

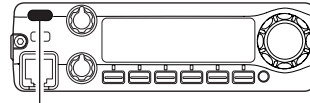

Hold down [P] for 1 second.

Push [V/MHz] to select the VFO mode.

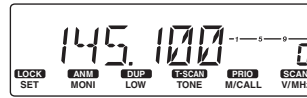

VFO mode

Push [M/CALL] to select the memory mode.

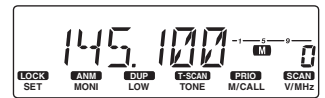

Memory mode

Using the HM-133V

- ➔ Push [VFO] to select the VFO mode.

■ Using the dial

- ➔ Rotate [DIAL] to set the frequency.
 - If necessary, push [V/MHz] to select the VFO mode.
 - The frequency changes according to the selected tuning step. (p. 6)
 - Push [V/MHz] one or more times, to toggle the frequency step between 1 MHz and 10 MHz, if desired.

Rotate [DIAL] to set the frequency.

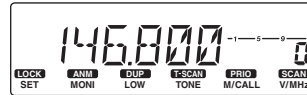

In the VFO mode

If the scan starts:

- Holding down [SCAN] (V/MHz) for 1 second will start a **scan**. Push [V/MHz] again to cancel it.

Push [V/MHz] to toggle the tuning step.

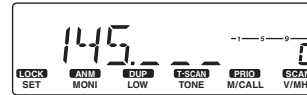

The 1 MHz tuning step is selected

■ Using the keypad on the HM-133V

- 1 If necessary, push [VFO] to select the VFO mode.
- 2 Push [ENT] to activate the keypad for numerical input.
- 3 Push 6 keys to input the frequency.
 - When a digit is mistakenly input, push [ENT] to clear the input, and then re-enter from the 1st digit.
 - Push [CLR] to clear the input digits and recall the previous frequency.

[EXAMPLE]: Setting the frequency to 145.3625 MHz.



Push

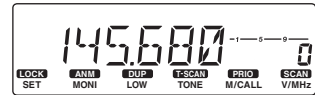

Push

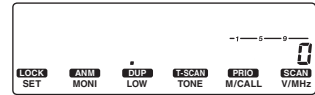

Push

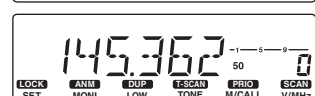
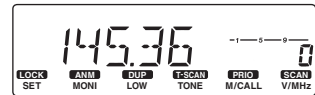

Push

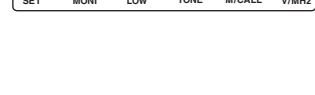

■ Using [▲] or [▼] on the HM-133V

- ➔ Push [▲] or [▼] to select the desired frequency.
 - Holding down [▲] or [▼] for 1 second activates a scan. If a scan has started, push [▲] or [▼] again or push [CLR] to cancel it.

■ Tuning step selection

The tuning step is the smallest selectable frequency increment you can set the operating frequency. The following tuning steps are selectable.

- 5 kHz • 6.25 kHz • 10 kHz • 12.5 kHz • 15 kHz
- 20 kHz • 25 kHz • 30 kHz • 50 kHz

NOTE: For convenience, select the tuning step that matches the frequency intervals of the repeaters in your area.

- ① If necessary, push [V/MHz] to select the VFO mode.
- ② Push [SET] to enter the Set mode.
- ③ Push [SET] or [MONI] one or more times, until “TS” appears, as shown to the right.
- ④ Rotate [DIAL] to select the desired tuning step.
- ⑤ Push any key, other than [SET] or [MONI], to save the entry and exit the Set mode.

15 kHz tuning step



Using the HM-133V

- ① If necessary, push [VFO] VFO/LOCK to select the VFO mode.
- ② Push [SET] D-OFF SET B to enter the Set mode.
- ③ Push [SET] D-OFF SET B or [ENT] T-OFF ENT C one or more times until “TS” appears.
- ④ Push [▲] or [▼] to select the desired tuning step.
- ⑤ Push [CLR] MW CLR A to save the entry and exit the Set mode.

■ Lock functions

Use the Lock function to prevent accidental channel changes and unnecessary function access. The IC-2300H has two different lock functions.

◇ Lock function

This function electronically locks **[DIAL]** and the keypad. This function can be used together with the Microphone Lock function.

- ➔ Hold down **[LOCK]** (SET) for 1 second to turn the Lock function ON or OFF.
 - **[PTT]**, **[MONI]**, **[VOL]** and **[SQL]** can be used, even while the Frequency Lock function is ON. TONE-1, TONE-2, DTMF tones or DTMF memory contents can also be transmitted from the microphone.

Hold down **[LOCK]** (SET) for 1 second.

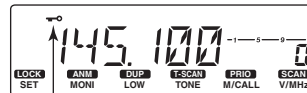

Appears

Using the HM-133V

- ➔ Hold down **[LOCK]** (VFO/LOCK) for 1 second to turn the Lock function ON or OFF.

Hold down (VFO/LOCK) for 1 second.

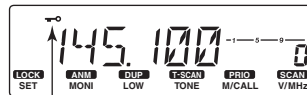

Appears

◇ Microphone Keypad Lock

This function electronically locks the microphone keypad.

- ➔ Push **[FUNC]** (FUNC) then **[16KEY-L]** (16KEY-L/SQL#) to turn the Microphone Keypad Lock function ON or OFF.
 - The activity indicator lights orange, while the Microphone Keypad Lock function is activated.
 - **[PTT]**, **[VFO/LOCK]** (VFO/LOCK), **[MR/CALL]** (MR/CALL), **[BANK/OPTION]** (BANK/OPTION), **[▲]**, **[▼]**, **[F-1]** (F-1), **[F-2]** (F-2), **[DTMF-S]** (DTMF-S) and **[FUNC]** (FUNC) on the microphone can be used.
 - All keys on the transceiver can be used.
 - When the transceiver's power is turned OFF, the Keypad Lock function is also turned ON.

Push (FUNC), then (16KEY-L/SQL#).

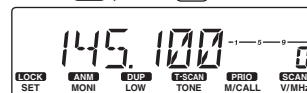

Receiving

- ① Hold down [⏻] for 1 second to turn ON the power.
- ② Rotate [VOL] to adjust the audio level.
 - ➔ Push [MONI] to open the squelch, and then rotate [VOL] to adjust the audio level.
- ③ Set the squelch level.
 - ➔ First, rotate [SQL] fully counterclockwise, and then rotate [SQL] clockwise until the noise just disappears.
- ④ Set the operating frequency. (p. 5)
- ⑤ When you receive a signal, the squelch opens and audio can be heard.
 - The “BUSY” icon appears, and the S/RF indicator shows the relative strength of the received signal.

Appears when receiving a signal.

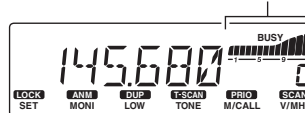

Using the HM-133V

The audio level can also be adjusted by pushing [VOL▲] ^(TONE-2 VOL▲) or [VOL▼] ^(TONE-2 VOL▼).

Push ^(TONE-2 VOL▲) / ^(TONE-2 VOL▼) to adjust the audio level.

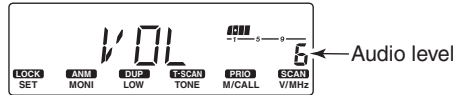

The squelch level can also be adjusted by pushing [SQL▲] ^(MUTE SQL▲) or [SQL▼] ^(MUTE SQL▼).

Push ^(MUTE SQL▲) / ^(MUTE SQL▼) to adjust the squelch level.

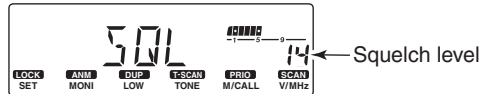

Monitor function

This function is used to listen to weak signals without disturbing the squelch setting, or to manually open the squelch, even when the **tone squelch** is in use.

- ➔ Push [MONI] to open the squelch.
 - The “BUSY” icon blinks.
 - Push [MONI] again to cancel the function.

Push [MONI] to open the squelch.

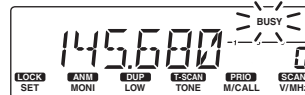

Using the HM-133V

- ➔ Push [MONI] ^(ANI MONI) to open the squelch.
 - Push [MONI] ^(ANI MONI) again to cancel the function.

Push ^(ANI MONI) to open the squelch.

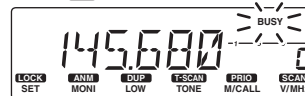

NOTE: When the squelch adjustment is set to too far clockwise (12–17 o'clock position), the S-meter squelch or squelch attenuator is activated. To monitor weak signals, deactivate the S-meter squelch or squelch attenuator function. See page 9 for details.

■ Audio mute function

This function temporarily mutes the audio without disturbing the volume setting.

- ➔ Push **[FUNC]** (FUNC) then **[MUTE]** (MUTE SQLAD) to mute the audio.
 - The “MUTE” icon appears.
 - Push **[CLR]** (MW CLR A) to cancel the function.

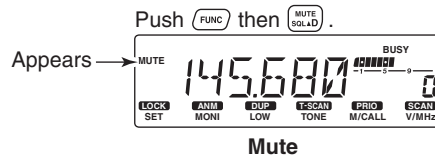

■ Squelch attenuator

The transceiver has an RF **attenuator** related to the squelch level setting. Approximately 20 dB of attenuation is obtained at the maximum setting.

Turn ON the Squelch Attenuator function:

- ① Push **[PWR]** to turn OFF the power.
- ② While holding down **[LOCK]** (SET), hold down **[PWR]** for 1 second to turn ON the power and enter the Initial Set mode.
- ③ Push **[SET]** or **[MONI]** one or more times, to select the “SQL” item.
- ④ Rotate **[DIAL]** to select “AT” (Attenuator).
- ⑤ Push **[PWR]** to exit the Initial Set mode.
- ⑥ Rotate **[SQL]** clockwise further than the 12 o'clock position, to activate the squelch attenuator.
 - The attenuation level can be adjusted up to 20 dB (approximately), between the 12 o'clock and fully clockwise positions.
 - When setting the squelch from the microphone, the level greater than ‘17’ activates the squelch attenuator.

NOTE: When using with the Monitor function.
 The squelch attenuator functions even when the Monitor function is in use. It is recommended to set **[SQL]** between 10 and 12 o'clock (7 to 17 level when it is set using the HM-133V).

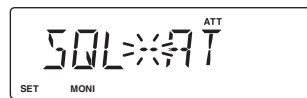

Squelch attenuator

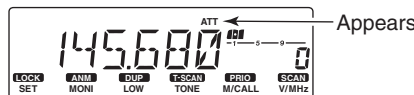

While the squelch attenuator is turned ON. ([DIAL] is set between the 12 o'clock and fully clockwise positions.)

■ S-meter squelch

The transceiver has an S-meter squelch. The S-meter squelch allows you to set minimum signal level needed to open the squelch.

Turn ON the S-meter Squelch function:

- ① Push **[PWR]** to turn OFF the power.
- ② While holding down **[LOCK]** (SET), hold down **[PWR]** for 1 second to turn ON the power and enter the Initial Set mode.
- ③ Push **[SET]** or **[MONI]** one or more times, to select the “SQL” item.
- ④ Rotate **[DIAL]** to select “SS” (S-meter squelch).
- ⑤ Push **[PWR]** to exit the Initial Set mode.
- ⑥ Rotate **[SQL]** clockwise further than the 12 o'clock position, to activate the S-meter squelch.

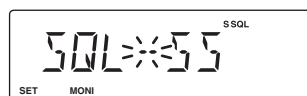

S-meter squelch

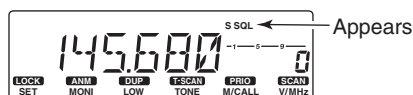

While the S-meter squelch is turned ON. ([DIAL] is set between the 12 o'clock and fully clockwise positions.)

■ Transmitting

CAUTION: Transmitting without an antenna will damage the transceiver.

NOTE: To prevent interference, listen on the channel before transmitting by opening the squelch. To open the squelch, rotate **[DIAL]** counterclockwise or push **[SQL▼]** (KEY) (SQL#) on the microphone.

- ① Set the operating frequency. (p. 5)
 - Adjust the output power if desired. See page 11 for the details.
- ② Hold down **[PTT]** to transmit.
 - The “**TX**” icon appears.
 - The S/RF indicator shows the output power level.
 - The One-Touch PTT function can be used. See page 11 for details.
- ③ Speak into the microphone at your normal voice level.
 - DO NOT hold the microphone too close to your mouth, or speak too loudly. This may distort the signal.
- ④ Release **[PTT]** to receive.

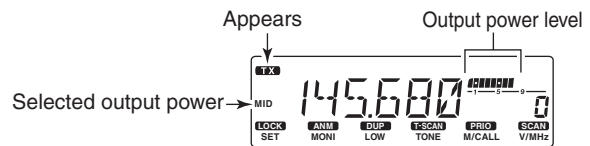

IMPORTANT! (for 65 W transmission):

The IC-2300H has a built-in current detector circuit which protects the power amplifier from excessive current flow. When excessive current flow is detected, the circuit automatically reduces the transmit output power to approximately 25 watts.

The IC-2300H has a thermal detector circuit too, which protects the power amplifier from excessive heat. As the temperature increases, the circuit automatically reduces the transmit output power to approximately 10 to 20 watts.





■ Selecting output power

The IC-2300H has 4* output power levels to suit your operating requirements. Lower output powers during short-distance communications may reduce the possibility of interference to other stations and will reduce current consumption.

*The Taiwan version has only 3 output power level options.

- ➔ Push **[LOW]** one or more times to select the output power.
 - The output power can be changed even while transmitting.

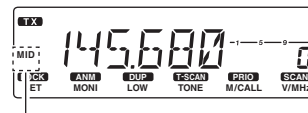

• OUTPUT POWER (approximately)

	USA, Export	Taiwan	Korea
High: 	65 W	24 W	50 W
Mid: 	25 W	10 W	25 W
Mid-Low: 	10 W	—	10 W
Low: 	5 W	5 W	5 W



The selected output power is displayed here. (If "High" is selected, no icon is displayed.)





Using the HM-133V

- ➔ Push **[HIGH]**  for high output power; **[MID]**  for mid-low output power (push again for mid output power); and **[LOW]**  for low output power.
 - When using the microphone, output power can be changed only while receiving.

■ One-touch PTT function

The PTT switch can be operated as a one-touch PTT switch (each push switches between transmit and receive). Using this function you can transmit without holding down the PTT switch.

To prevent accidental continuous transmissions with this function, the transceiver has a time-out timer. See page 48 for details.

- 1 Push **[FUNC]**  then **[PTT-M]**  to turn ON the One-Touch PTT function.
 - The activity indicator lights green.
- 2 Push **[PTT]** to transmit and push again to receive.
 - Two beeps sound when transmit starts, and a long beep sounds when returning to receive.
 - The "TX" icon blinks while the One-Touch PTT function is ON.
- 3 Push **[FUNC]**  then **[PTT-M]**  to turn OFF the One-Touch PTT function.
 - The activity indicator goes out.

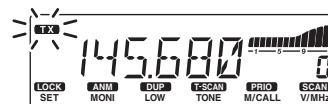

■ Accessing a repeater

- ① Set the receive frequency (repeater output frequency). (p. 5)
 - **For only USA versions:**
 - When the Auto Repeater function is set to “R1” (p. 16), steps ② and ③ are not necessary.
 - When the Auto Repeater function is set to “R2” (p. 16), steps ② to ④ are not necessary.
- ② Set the frequency offset in the Set mode. (p. 15)
- ③ Hold down **[DUP]** (LOW) for 1 second, once or twice, to select the minus duplex or the plus duplex mode.
 - The “-” or “+” icon appears to represent the frequency offset direction.
- ④ Push **[TONE]** one or more times to turn ON the subaudible tone encoder, depending on the repeater requirements.
 - The “♪” icon appears
 - The 88.5 Hz tone frequency is set as the default. But some repeaters may require a different tone frequency to access. Refer to page 13 for setting the tone frequency.
- ⑤ Hold down **[PTT]** to transmit.
 - The displayed frequency automatically changes to the transmit frequency (repeater input frequency).
 - If “OFF” appears, confirm that the frequency offset is correctly set. (p. 15)
- ⑥ Release **[PTT]** to receive.
- ⑦ Push **[MONI]** to check whether you can directly receive the signal from the other station.
- ⑧ To return to the simplex mode, hold down **[DUP]** (LOW) for 1 second, once or twice, to clear the “-” or “+” icon.
- ⑨ To turn OFF the subaudible tone encoder, push **[TONE]** one or more times until no tone icon appears.

Using the HM-133V

- ① Set the receive frequency (repeater output frequency). (p. 5)
- ② Set the frequency offset in the Set mode. (p. 15)
- ③ Push **[DUP-]** (TONE DUP-7) to select the minus duplex mode, or push **[DUP+]** (TSOL+ DUP+8) to select the plus duplex mode.
- ④ Push **[FUNC]** (FUNC) then **[TONE]** (TONE DUP-7) to turn ON the subaudible tone encoder, depending on the repeater requirements.
 - Refer to page 13 for setting the tone frequency.
 - When the repeater requires a different tone system, see page 14.
- ⑤ Hold down **[PTT]** to transmit.
- ⑥ Release **[PTT]** to receive.
- ⑦ Push **[MONI]** (MONI1) to check whether you can directly receive the signal from the other station.
- ⑧ Push **[SIMP]** (TSOL SHP9) to return to the simplex mode.
 - The “+” or “-” icon disappears.
- ⑨ To turn OFF the subaudible tone encoder, push **[FUNC]** (FUNC) then **[T-OFF]** (T-OFF ENT C).

[i.e.]: Select the minus duplex mode, and then turn ON the subaudible tone encoder.

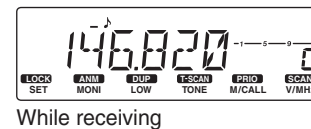
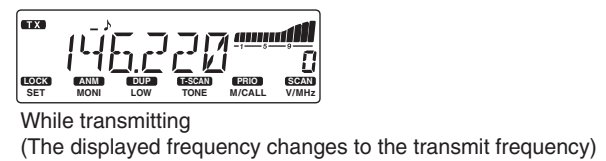
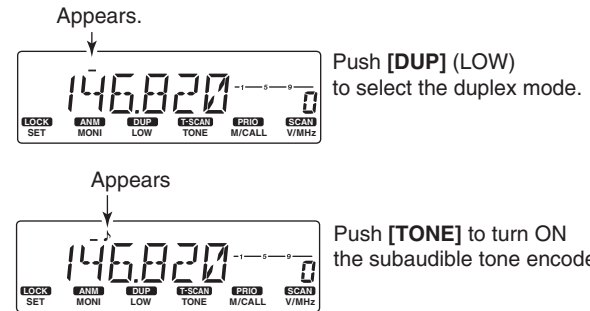

[i.e.]: Select the plus duplex mode, and then turn ON the subaudible tone encoder.

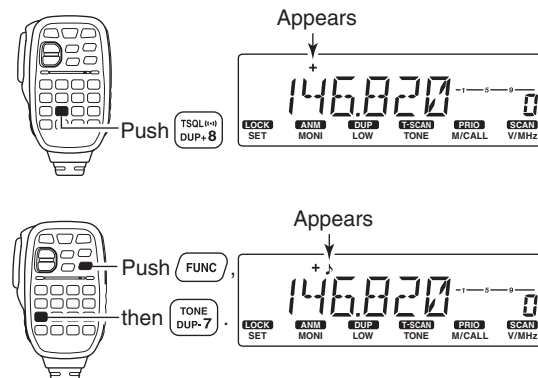

■ Subaudible tones (Encoder function)

◇ Subaudible tones

- ① Select the channel that you want to set the subaudible tone to, such as the VFO, memory or Call channel.
 - The subaudible tone frequency or code is independently programmed into each mode or channel.
- ② Push [SET] to enter the Set mode.
- ③ Push [SET] or [MONI] one or more times until the “” icon and “Ct” (for the CTCSS), the “” icon and “dt” (for the DTCS) or the “” icon and “rt” (for the repeater tone) appear.
- ④ Rotate [DIAL] to select the desired subaudible frequency or code.
- ⑤ Push any key other than [SET] or [MONI], to save the entry and exit the Set mode.

Setting the tone frequency



Setting the DTCS code



Setting the repeater tone frequency

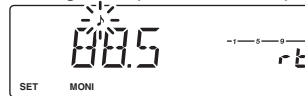

NOTE: The subaudible tone encoder frequency can be temporarily set in a memory or Call channel. However, when another memory channel or VFO mode is selected, the set frequency is cleared. To store the tone frequency permanently, overwrite the channel information.

Using the HM-133V



- ① Select the mode or channel that you want to set the subaudible tones to, such as the VFO, memory or Call channel.
 - The subaudible tone frequency or code is independently programmed into each mode and channel.
- ② Push [SET] D-OFF SET B to enter the Set mode.
- ③ Push [SET] D-OFF SET B or [ENT] T-OFF ENT C one or more times until the “” icon and “Ct” (for the CTCSS), the “” icon and “dt” (for the DTCS) or the “” icon and “rt” (for the repeater tone) appear.
- ④ Push [▲] or [▼] to select and set the desired subaudible tone frequency or code.
 - Push and hold [▲] or [▼] to sequentially change the tones or codes.
- ⑤ Push [CLR] MW CLR A to save the entry and exit the Set mode.

• Subaudible tone frequency list (unit: Hz)

67.0	79.7	94.8	110.9	131.8	156.7	171.3	186.2	203.5	229.1
69.3	82.5	97.4	114.8	136.5	159.8	173.8	189.9	206.5	233.6
71.9	85.4	100.0	118.8	141.3	162.2	177.3	192.8	210.7	241.8
74.4	88.5	103.5	123.0	146.2	165.5	179.9	196.6	218.1	250.3
77.0	91.5	107.2	127.3	151.4	167.9	183.5	199.5	225.7	254.1

3 BASIC OPERATION

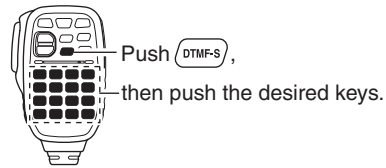

◇ DTMF tones

- ① When "d" is displayed in the 100 MHz digit, first cancel the **DTMF** memory encoder. (p. 37)
- ② Push **[DTMF-S]** , then push the keys of the desired DTMF digits.
 - The function indicator lights green.
 - 0–9, A–D, *(E) and #(F) are selectable.
 - Push **[DTMF-S]**  again to return to the normal keypad mode.
 - The transceiver has ten DTMF memory channels for autopatch operation. See page 36 for details.



◇ 1750 Hz tone

The microphone has 1750 Hz tone capability, used as a ring tone when calling, and so on.

- ① Push **[FUNC]** .
- The function indicator lights orange.
- ② Push **[TONE-1]**  to transmit a 1750 Hz tone call signal for 1 second (approximately); hold down **[TONE-2]**  to continuously transmit a 1750 Hz tone call signal.
 - The function indicator automatically goes out.

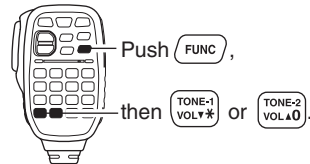

Frequency Offset

When communicating through a **repeater**, the transmit frequency is shifted up or down from the receive frequency.

- ① Push **[SET]** to enter the Set mode.
- ② Push **[SET]** or **[MONI]** until the “±” icon and the frequency offset appear.
- ③ Rotate **[DIAL]** to set the desired frequency offset.
 - Push **[V/MHz]** one or more times, to toggle the frequency step between 1 kHz and 1 MHz.
- ④ Push any key other than **[SET]** or **[MONI]**, to save the selection and exit the Set mode.



Using the HM-133V

- ① Push **[SET]** D-OFF SET B to enter the Set mode.
- ② Hold down **[SET]** D-OFF SET B or **[ENT]** T-OFF ENT C until the “±” icon and the frequency offset appear.
- ③ Push **[▲]** or **[▼]** to set the desired offset.
 - The frequency cannot be directly entered using the keypad.
- ④ Push **[CLR]** HW CLR A to save the selection and exit the Set mode.

Push **[SET]** D-OFF SET B to enter the Set mode,

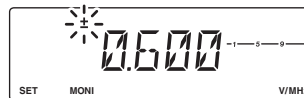

Repeater Lockout

This function helps prevent interference to other stations by inhibiting transmitting when a signal is received. The transceiver has two inhibiting conditions, repeater and busy.

- ① Push **[PWR]** to turn OFF the power.
- ② While holding down **[SET]**, push **[PWR]** to turn ON the power and enter the Initial Set mode.
- ③ Push **[SET]** or **[MONI]** until “RLO” appears.
- ④ Rotate **[DIAL]** to select the Repeater Lockout function option of “RP” “BU” or “OF”:
 - “OF”: The Repeater Lockout function is OFF.
 - “RP”: Transmit is inhibited when a signal with an un-matched subaudible tone is received.
 - “BU”: Transmit is inhibited when a signal is received.
- ⑤ Push **[PWR]** to save the selection and exit the Initial Set mode.

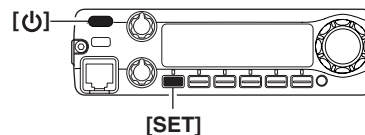

The Repeater Lockout function OFF (default)

■ Reversed Duplex function

When the reversed **duplex** function is ON, the receive frequency shifts. (The transmit frequency shifts in normal duplex mode.) An example receive and transmit frequency is shown in the table below with the following settings:

Input frequency : 145.30 MHz
 Offset direction : - (Negative)
 Offset frequency : 0.6 MHz

Reversed	OFF	ON
Rx frequency	145.30 MHz	144.70 MHz
Tx frequency	144.70 MHz	145.30 MHz

- ① Push **[SET]** to enter the Set mode.
- ② Push **[SET]** or **[MONI]** one or more times until “REV” appears.
- ③ Rotate **[DIAL]** to turn the reversed duplex mode ON or OFF.
- ④ Push any key other than **[SET]** or **[MONI]**, to save the selection and exit the Set mode.

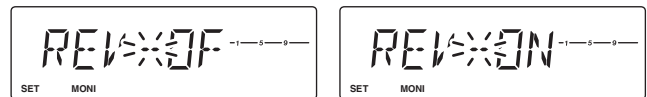

The reversed duplex mode: OFF The reversed duplex mode: ON

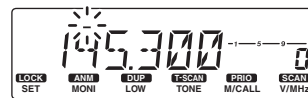

The duplex icon blinks while the Reversed Duplex function is turned ON.

Using the HM-133V

- ① Push **[SET]** ^(D-OFF SET B) to enter the Set mode.
- ② Push **[SET]** ^(D-OFF SET B) or **[ENT]** ^(T-OFF ENT C) until “REV” appears.
- ③ Push **[▲]** or **[▼]** to turn the reversed duplex mode ON or OFF.
- ④ Push **[CLR]** ^(MW CLR A) to save the selection and exit the Set mode.



■ Auto repeater (Only USA versions)

The USA version automatically activates the **repeater** settings (DUP- or DUP+ and tone encoder ON/OFF), when the operating frequency falls within the general repeater output frequency range, and deactivates them when outside of the range.

◇ Setting the Auto Repeater function ON/OFF

- ① Push **[P]** to turn OFF power.
- ② While holding down **[LOCK]** (SET), hold down **[P]** to turn ON the power and enter the Initial Set mode.
- ③ Push **[SET]** until “RPT” appears as shown below.
- ④ Rotate **[DIAL]** to turn the Auto Repeater function to “R1,” “R2” or “OF.”
 - “OF”: Auto repeater is OFF.
 - “R1”: Auto repeater is ON, tone encoder is OFF.
 - “R2”: Auto repeater is ON, tone encoder is ON.
- ⑤ Push **[P]** to exit the Initial Set mode.



Auto repeater function is turned OFF.

Auto repeater function is ON, tone encoder is ON.

◇ Frequency range and offset direction

Frequency range	Duplex direction
145.200–145.495 MHz 146.610–146.995 MHz	“-” appears
147.000–147.395 MHz	“+” appears

5 MEMORY OPERATION

General description

The transceiver has 207 memory channels including 6 scan edge memory channels (3 pairs), and 1 Call channel. These channels can be individually programmed with:

- Operating frequency (p. 5)
- Duplex direction (p. 12) and offset (p. 15)
- Subaudible tone or tone squelch and tone frequency (pp. 13, 39–41)
- Skip setting* (p. 32)

In addition, a total of 10 memory banks; A to J, are selectable for use by groups, and so on.

*except for scan edge memory channels.

Programming a memory channel

The VFO settings, including the Set mode contents such as subaudible tone frequency, and so on, can be programmed into a memory channel.

- ① Set the desired frequency in the VFO mode.
- ② Push **[S.MW]**.
 - The “M” icon and the memory channel number blink.
- ③ Rotate **[DIAL]** to select the memory channel to be programmed.
 - If the selected channel is blank, only the memory channel number is displayed.
- ④ Hold down **[MW]** (S.MW) for 1 second to program.
 - 3 beeps sound.
 - The memory channel number increases, when continuing to hold down **[MW]** (S.MW) after programming.

✓ CONVENIENT

Memory programming can be performed in several ways. Example; Programming the memory channel to the same (or different) memory channel, memory channel to the Call channel, and so on.

Using the HM-133V

- ① Set the desired frequency in the VFO mode.
- ② Push **[FUNC]**, and then push **[MW]**.
 - The “M” icon and the memory channel number blink.
- ③ Push **[▲]** or **[▼]** to select the memory channel to be programmed. (direct numeric input cannot be used.)
- ④ Push **[FUNC]**, and then hold down **[MW]** for 1 second to program.
 - ➔ 3 beeps sound and the VFO contents (including the subaudible tone frequency, and so on.) are programmed.
 - ➔ The memory channel number increases, when continuing to hold down **[MW]** after programming.

[i.e.]: Programming 145.870 MHz into memory channel 20 via the front panel.

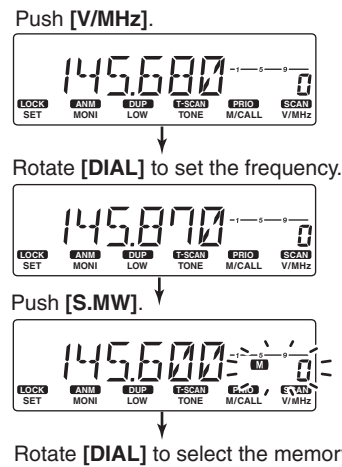

Rotate **[DIAL]** to select the memory channel to be programmed.

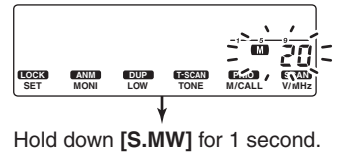

Hold down **[S.MW]** for 1 second.

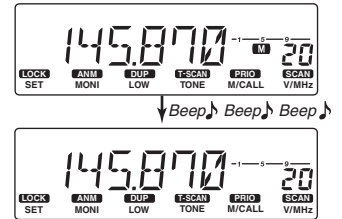

[i.e.]: Programming 145.870 MHz into the memory channel 20, using the microphone.

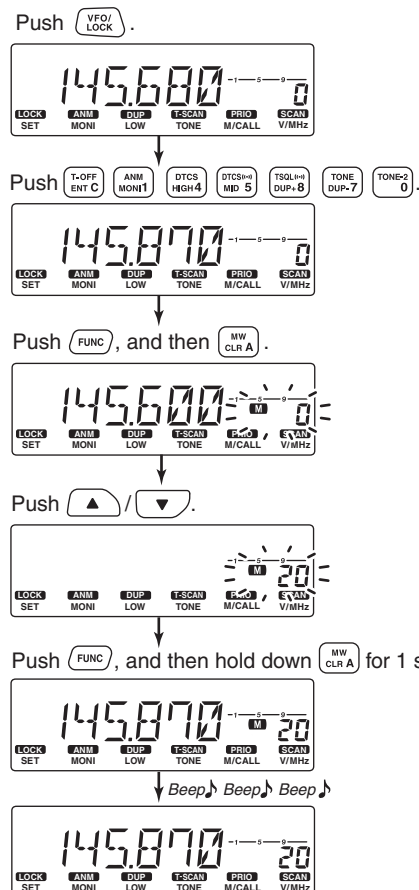

Push **[FUNC]**, and then hold down **[MW CLR A]** for 1 second.

Memory channel selection

Using the tuning dial

- ① Push [M/CALL] once or twice to select the memory mode.
 - The “M” icon appears.
- ② Rotate [DIAL] to select the desired memory channel.
 - Only programmed memory channels can be selected.

[i.e.]: Selecting memory channel 2.

Push [M/CALL] to select the memory mode.

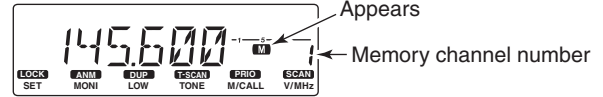

Rotate [DIAL] to select the desired memory channel.

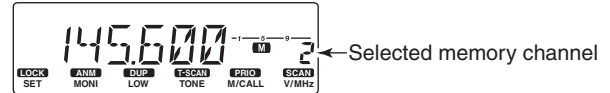

Using [▲] or [▼] on the HM-133V

- ① Push [MR] to select the memory mode.
- ② Push [▲] or [▼] to select and set the desired memory channel.
 - Pushing [▲] or [▼] for 1 second activates a scan. If a scan starts, push [CLR] to stop it.

[i.e.]: Selecting memory channel 2.

Push [MR] to select the memory mode.

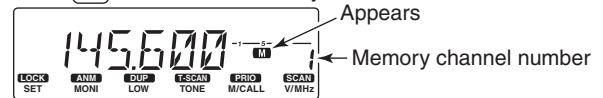

Push [▲] / [▼] to select the desired memory channel.

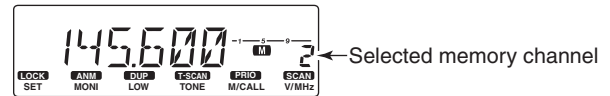

Using the keypad on the HM-133V

- ① Push [MR] to select the memory mode.
- ② Push [ENT] to activate the keypad for numerical input.
- ③ Push three appropriate numeric keys to input a channel number.
 - Push only 1 appropriate digit key, [1], [2] or [3], and then push [*] or [#] to select the scan edge channels. “*” and “#” can be used for “A” and “B” respectively.

[i.e.]: Selecting memory channel 2.

Push [MR] to select the memory mode.

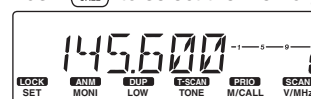

Push [ENT].

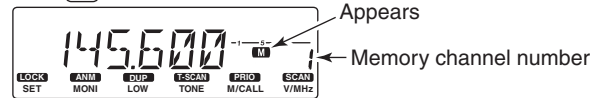

Push [ENT], and then push [TONE-VOL+0] [TONE-VOL+0] [SCAN-SCAN2].

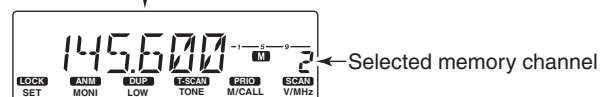
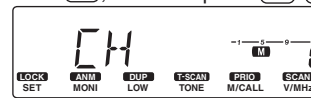

■ Copying memory contents

This function copies a memory channel's contents to the **VFO**, another memory or Call channel. This function is useful when searching for signals around the memory channel frequency, and for easy recalling the frequency offset, subaudible tone frequency, and so on.

◇ Memory/Call channel → VFO

- ① Select the memory or Call channel to be copied.
 - ② Hold down **[MW]** (S.MW) for 1 second to copy the selected memory or Call channel contents to the VFO.
- The VFO mode is automatically selected.

[i.e.]: Copying memory channel 30 contents to the VFO.

Push **[M/CALL]** to select the memory mode.

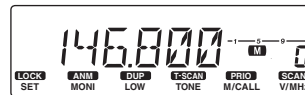

Rotate **[DIAL]** to select the memory channel.

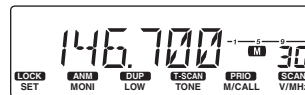

Hold down **[MW]** (S.MW) for 1 second.

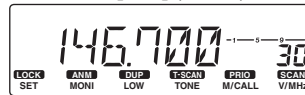

VFO mode

Using the HM-133V

- ① Select the memory or Call channel to be copied.
 - ② Push **[FUNC]** (FUNC), and then hold down **[MW]** (MW CLR A) for 1 second, to copy the contents of selected memory or Call channel to the VFO.
- The VFO mode is automatically selected.

[i.e.]: Copying memory channel 30 contents to the VFO.

Push **[M/CALL]** to select the memory mode.

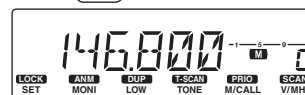

Select the memory channel.

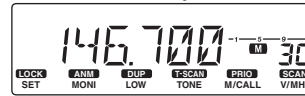

Push **[FUNC]**, and then hold down **[MW]** (MW CLR A) for 1 second.

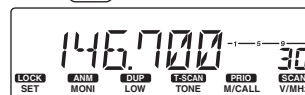

VFO mode

◇ **Memory/Call channel → Call/memory channel**

- ① Select the memory or Call channel to be copied.
- ② Push **[S.MW]**.
 - The “**M**” icon and “— —” indication blink.
- ③ Rotate **[DIAL]** to select the target memory channel.
 - “**C**” blinks when the Call channel is selected.
 - **Scan edge** channels; 1A/1b, 2A/2b, 3A/3b, are also selectable.
- ④ Hold down **[MW]** (S.MW) for 1 second, to copy the contents of selected memory or Call channel to the target memory.
 - The targeted memory and copied contents are displayed.

[i.e.]: Copying memory channel 30 contents to channel 31.

Select the memory channel.

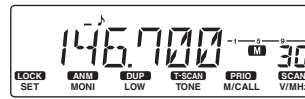

Push **[S.MW]**.

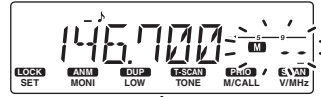

Rotate **[DIAL]** to select the target channel.

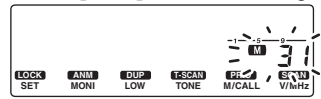

Hold down **[MW]** (S.MW) for 1 second.

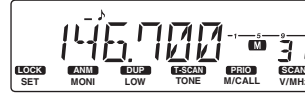

Using the HM-133V

- ① Select the memory or Call channel to be copied.
- ② Push **[FUNC]** (FUNC), and then push **[MW]** (MW CLR A).
 - The “**M**” icon and “— —” indication blink, and the VFO frequency is displayed.
- ③ Push **[▲]** or **[▼]** to select the target memory channel.
 - “**C**” blinks when the Call channel is selected.
 - Scan edge channels can also be selected.
 - The keypad cannot be used for setting the channel.
- ④ Push **[FUNC]** (FUNC), and then hold down **[MW]** (MW CLR A) for 1 second to copy the contents of selected memory or Call channel to the target memory.
 - The targeted memory and copied contents are displayed.

[i.e.]: Copying memory channel 30 contents to channel 31.

Select the memory channel.

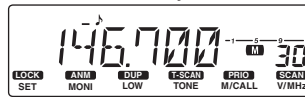

Push **[FUNC]**, and then push **[MW CLR A]**.

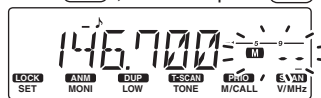

Push **[▲]** / **[▼]** to select the target channel.

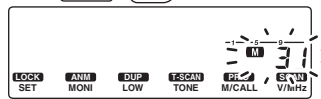

Push **[FUNC]**, and then hold down **[MW CLR A]** for 1 second.

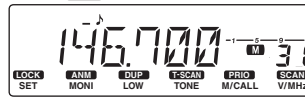

■ Programming channel names

Each memory channel and the Call channel can be programmed with an alphanumeric channel name, for easy recognition. Names can be a maximum of 6 characters— see the table to the right, for the selectable characters.

- ① Push **[M/CALL]** to select the memory mode.
- ② Rotate **[DIAL]** to select the desired memory channel.
- ③ Hold down **[ANM]** (MONI) for 1 second to switch the channel name display.
 - Two beeps sound.
 - The name is displayed, if programmed.
- ④ Push **[SET]** to enter the channel name programming mode.
- ⑤ Rotate **[DIAL]** to select a character.
 - The selected character blinks.
- ⑥ Push **[SET]** or **[MONI]** to move the cursor to the left or right.
- ⑦ Repeat steps ⑤ and ⑥, until the desired channel name is completed.
- ⑧ Push any key other than **[SET]** or **[MONI]**, to program the name and exit the channel name programming mode.
 - To switch to the frequency display, hold down **[MONI]** (ANM) for 1 second again.

IMPORTANT!: While the channel name display mode is selected, and when **[SET]** is pushed, the channel name programming mode is always accessed.

To access the Set mode, cancel the channel name display by holding down **[MONI]** (ANM) for 1 second.

A(A)	B(B)	C(C)	D(D)	E(E)	F(F)	G(G)	H(H)	I(I)	J(J)
K(K)	L(L)	M(M)	N(N)	O(O)	P(P)	Q(Q)	R(R)	S(S)	T(T)
U(U)	V(V)	W(W)	X(X)	Y(Y)	Z(Z)	1(1)	2(2)	3(3)	4(4)
5(5)	6(6)	7(7)	8(8)	9(9)	0(0)	!(!)	"(")	#(#)	\$(\$)
%(%)	&(&)	'(')	((() ()	*(*)	+ (+)	, (,)	-- (-)	, (,)
/ (/)	: (:)	: (:)	< (<)	= (=)	> (>)	? (?)	@ (@)	␣ (␣)	\ (\)
] (])	^ (^)	(space)							

[i.e.]: Programming “CLUB” into memory channel 5.
Select memory channel 5, and then hold down **[ANM]** (MONI) for 1 second.

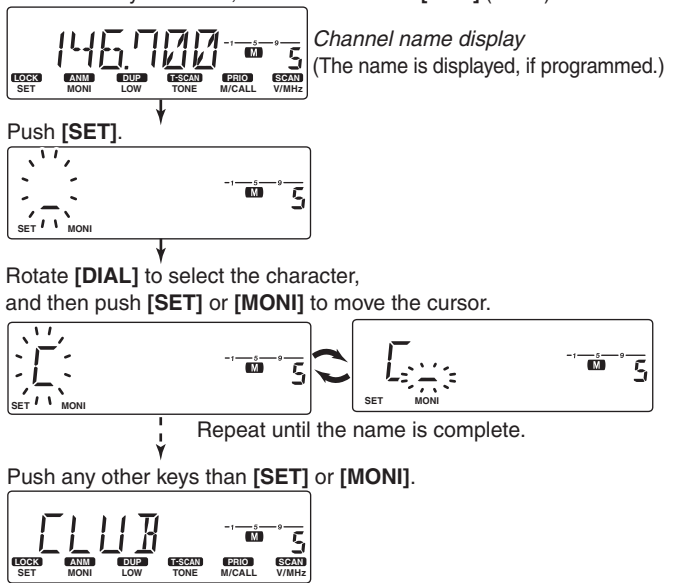

Using the HM-133V

- ① Select the memory or Call channel to be assigned the memory name.
- ② Push **[FUNC]** (FUNC), and then push **[ANM]** (ANM/MONIT).

 - The name is displayed, if programmed.

- ③ Push **[SET]** (D-OFF/SET B).
- ④ Push **[▲]** or **[▼]** to select the desired character.
 - The selected character blinks.
- ⑤ Push **[SET]** (D-OFF/SET B) or **[ENT]** (T-OFF/ENT C) to move the cursor to the left or right.
- ⑥ Repeat steps ④ and ⑤ until the desired channel names are completed.
- ⑦ Push **[CLR]** (MW/CLR A) to program the name and exit the channel name programming mode.
- ⑧ If desired, push **[FUNC]** (FUNC), and then push **[ANM]** (ANM/MONIT) to return to the frequency display.

[i.e.]: Programming “CLUB” into memory channel 5.
Select memory channel 5, push **[FUNC]** then **[ANM]**.

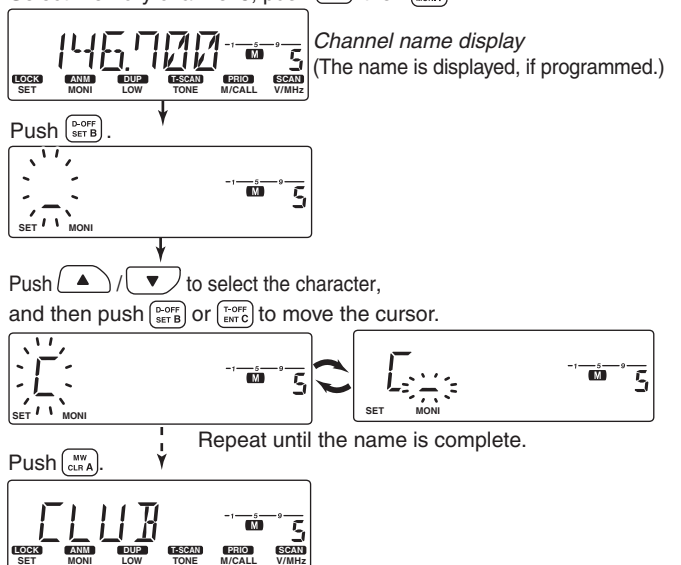

Memory clearing

Contents of programmed memories can be cleared (blanked).

- ① Push [V/MHz] to select the VFO mode.
- ② Push [S.MW].
 - The “M” icon and the memory channel number blink.
- ③ Rotate [DIAL] to select the memory channel to be cleared.
 - Memory channels not yet programmed are blank.
- ④ Push [S.MW], and then sequentially hold down [MW] (S.MW) again for 1 second
 - ☞ **This operation must be performed within 1.5 seconds.**
 - 3 beeps sound, and then the memory channel is cleared.
 - The “M” icon and memory channel number blink.
 - When clearing the Call channel, the current VFO contents are automatically re-programmed into the Call channel.
- ⑤ Push any key other than [S.MW], to return to the VFO mode.

/// **NOTE:** Be careful!— the contents of cleared memories CANNOT be recalled.

Using the HM-133V

- ① Push [VFO] ^{VFO/LOCK} to select the VFO mode.
- ② Push [FUNC] ^{FUNC}, and then push [MW] ^{MW CLR A}.
- ③ Push [▲] or [▼] to select the memory channel to be cleared.
 - The “M” icon and channel number blink.
 - Memory channels not yet programmed are blank.
- ④ Push [FUNC] ^{FUNC} then [MW] ^{MW CLR A}, and then push [FUNC] ^{FUNC} then hold down [MW] ^{MW CLR A} for 1 second.
 - ☞ **This operation must be performed within 1.5 seconds.**
 - 3 beeps sound, and then the memory channel is cleared.
 - The “M” icon and memory channel number blink.
 - When clearing the Call channel, the current VFO conditions are automatically re-programmed into the Call channel.
- ⑤ Push [CLR] ^{MW CLR A}, to return to the VFO mode.

[i.e.]: Clearing memory channel 20.

Push [V/MHz] to select the VFO mode.

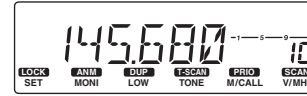

Push [S.MW].

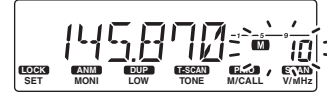

Rotate [DIAL] to select the memory channel.

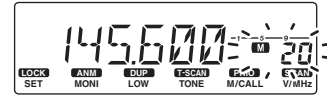

Push [S.MW], and within 1.5 seconds, hold down [MW] (S.MW) for 1 second again.

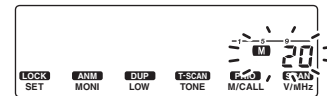

Push any key other than [S.MW].

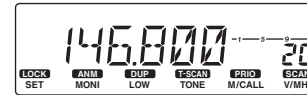

[i.e.]: Clearing memory channel 20.

Push [VFO/LOCK] to select the VFO mode.

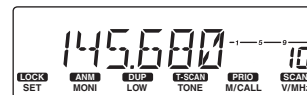

Push [FUNC] then [MW CLR A].

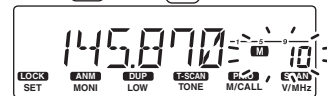

Rotate [▲]/[▼] to select the memory channel.

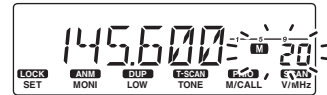

Push [FUNC] then [MW CLR A], and within 1.5 seconds, push [FUNC] then hold down [MW CLR A] for 1 second again.

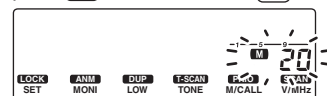

Push [MW CLR A].

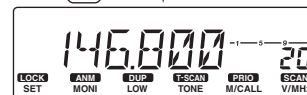

Memory bank setting

- ① Push **[M/CALL]** to select the memory mode, and then rotate **[DIAL]** to select the desired memory channel.
- ② Push **[SET]** to enter the Set mode.
- ③ Push **[SET]** or **[MONI]** until "BAK" appears.
 - "—" indication blinks.
- ④ Rotate **[DIAL]** to select the desired bank to be set.
- ⑤ Push any key other than **[SET]** or **[MONI]** to assign the channel into the selected bank and exit the Set mode.

[i.e.]: Setting memory channel 1 to bank "A."

Push **[SET]**.

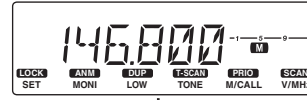

Push **[SET]** or **[MONI]** to select the "BAK" item.



Rotate **[DIAL]** to select the desired bank.

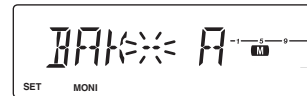

Using the HM-133V

- ① Push **[MR]** ^{MR/ CALL}, and then select the desired memory channel using **[▲]**, **[▼]** or keypad.
- ② Push **[SET]** ^{D-OFF SET B} to enter the Set mode.
- ③ Push **[SET]** ^{D-OFF SET B} or **[ENT]** ^{T-OFF ENT C} until "BAK" appears.
 - "—" indication blinks.
- ④ Push **[▲]** or **[▼]** to select the desired bank to be set.
- ⑤ Push **[CLR]** ^{MW CLR A} to assign the channel into the selected bank and exit the Set mode.

[i.e.]: Setting memory channel 1 to bank "A."

Push **[D-OFF SET B]**.

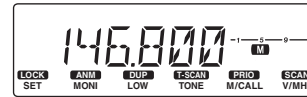

Push **[D-OFF SET B]** or **[T-OFF ENT C]** to select the "BAK" item.



Rotate **[▲]**/**[▼]** to select the desired bank.



Memory bank selection

The IC-2300H has a total of 10 banks (A to J). Regular memory channels; 0 to 199, and scan edges; 1A to 3B can be assigned into the desired bank for easy memory management.

- ① Push **[M/CALL]** to select the memory mode.
- ② Push **[BANK]** to select the **memory bank** mode.
 - The “**M**” icon and the bank letter blink.
- ③ Rotate **[DIAL]** to select the desired bank, “A” to “J.”
 - Banks that contain no memory channels are skipped.
- ④ Push **[BANK]** to set the bank.
 - The bank letter stops blinking.
- ⑤ Rotate **[DIAL]** to select the desired memory channel.
 - The channel number is not displayed in the memory bank mode.
- ⑥ To return to the regular memory mode, push **[BANK]** twice.

Using the HM-133V

- 1 Push **[MR]** (MR/ CALL) to select the memory mode.
- 2 Push **[BANK]** (BANK/ OPTION) to select the memory bank mode.
 - The “**M**” icon and the bank letter blink.
- 3 Push **[▲]** or **[▼]** to select the desired bank, A to J.
 - Banks that contain no memory channels are skipped.
- 4 Push **[CLR]** (MW CLR A) to set the bank.
 - The bank letter stops blinking.
- 5 Push **[▲]** or **[▼]** to select the desired memory channel.
 - The channel number is not displayed in the memory bank mode.
- 6 To return to the regular memory mode, push **[BANK]** (BANK/ OPTION), and then push **[CLR]** (MW CLR A).

[i.e.]: Selecting the memory bank “A.”

Push **[BANK]** to select the memory bank mode.

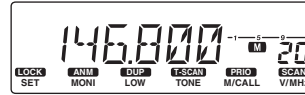

Rotate **[DIAL]** to select the desired bank.

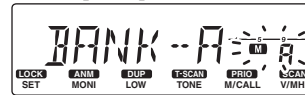

Push **[BANK]** again to set the bank.

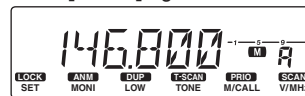

[i.e.]: Selecting the memory bank “A.”

Push **[BANK/ OPTION]** to select the memory bank mode.

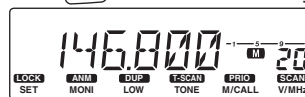

Push **[▲]** / **[▼]** to select the desired bank.

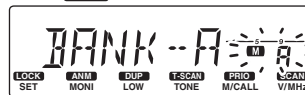

Push **[MW CLR A]** to set the bank.

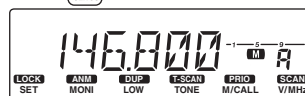

■ Transferring bank links

The link between a memory channels and it's assigned bank can be transferred to another bank.

- ① Push **[M/CALL]** to select the normal memory mode.
 - The “M” icon and the channel number appear.
- ② Push **[BANK]** to select the **memory bank** mode.
 - The “M” icon and the bank letter blink.
- ③ Rotate **[DIAL]** to select the desired bank, A to J.
 - Banks that contain no memory channels are skipped.
- ④ Push **[BANK]** to set the bank.
 - The bank letter stops blinking.
- ⑤ Rotate **[DIAL]** to select the desired memory channel to transfer.
- ⑥ Push **[SET]** to enter the Set mode.
- ⑦ Push **[SET]** or **[MONI]** until “BAK” appears.
 - Bank initial appears.
- ⑧ Rotate **[DIAL]** to select the destination bank.
- ⑨ Push any key other than **[SET]** or **[MONI]** to transfer and exit the Set mode.

Using the HM-133V

- ① Push **[MR]** (MR/ CALL) to select the memory mode.
- ② Push **[BANK]** (BANK/ OPTION), push **[▲]** or **[▼]** to select the desired memory bank, and then push **[CLR]** (MW CLR A) to select the bank.
- ③ Push **[▲]** or **[▼]** to select the desired bank link to be transferred.
- ④ Push **[SET]** (D-OFF SET B) to enter the Set mode.
- ⑤ Push **[SET]** (D-OFF SET B) or **[ENT]** (T-OFF ENT C) until “BAK” appears.
 - Bank initial appears.
- ⑥ Push **[▲]** or **[▼]** to select the destination bank.
- ⑦ Push **[CLR]** (MW CLR A) to transfer and exit the Set mode.

[i.e.]: Transferring the link of bank A to bank C.

Push **[BANK]** to select the memory bank mode.

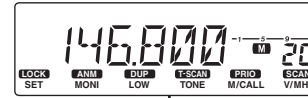

Rotate **[DIAL]** to select the desired bank.



Push **[SET]** to enter the Set mode.

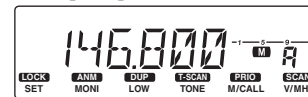

Push **[SET]** or **[MONI]** to select the “BAK” item.

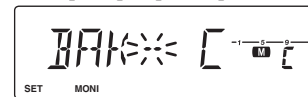

Rotate **[DIAL]** to select the bank to be transferred. (Or, select “-” to erase.)

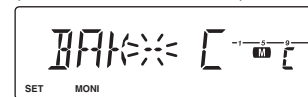

Push any key other than **[SET]** or **[MONI]**.

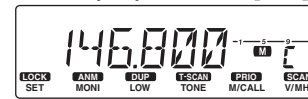

[i.e.]: Transferring the contents of bank A to bank C.

Push **[BANK/OPTION]** to select the memory bank mode.

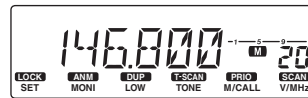

Push **[▲]**/**[▼]** to select the desired bank.



Push **[D-OFF SET B]** to enter the Set mode.

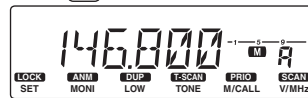

Push **[D-OFF SET B]**/**[T-OFF ENT C]** to select the “BAK” item.

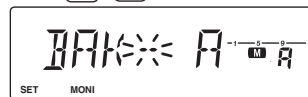

Push **[▲]**/**[▼]** to select the bank to be transferred. (Or, select “-” to erase.)

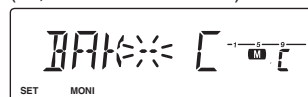

Push **[MW CLR A]**.

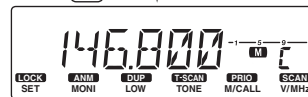

Erasing bank links

The link between a memory channel and its assigned bank can be erased.

INFORMATION: Even if the **memory bank** links are erased, the memory channel contents remain programmed.

- ① Push **[M/CALL]** to select the normal memory mode.
 - The “**M**” icon and the channel number appear.
- ② Push **[BANK]** to select the memory bank mode.
 - The “**M**” icon and the bank letter blink.
- ③ Rotate **[DIAL]** to select the desired bank, “A” to “J.”
 - Banks that contain no memory channels are skipped.
- ④ Push **[BANK]** to set the bank.
 - The “**M**” icon and bank letter stop blinking.
- ⑤ Rotate **[DIAL]** to select the desired memory channel to delete.
- ⑥ Push **[SET]** to enter the Set mode.
- ⑦ Push **[SET]** or **[MONI]** until “BAK” appears.
 - The bank letter also appears.
- ⑧ Rotate **[DIAL]** to select “--.”
- ⑨ Push any key other than **[SET]** or **[MONI]** to erase the selected memory channel link and then exit the Set mode.

Using the HM-133V

- ① Push **[MR]** (M/R CALL) to select the memory mode.
- ② Push **[BANK]** (BANK/OPTION), push **[▲]** or **[▼]** to select the desired memory bank, and then push **[CLR]** (M/W CLR A).
- ③ Push **[▲]** or **[▼]** to select the desired bank link to be erased.
- ④ Push **[SET]** (D-OFF SET B) to enter the Set mode.
- ⑤ Push **[SET]** (D-OFF SET B) or **[ENT]** (T-OFF ENT C) until “BAK” appears.
 - Bank initial appears.
- ⑥ Push **[▲]** or **[▼]** to select “--.”
- ⑦ Push **[CLR]** (M/W CLR A) to erase and exit the Set mode.

[i.e.]: Erasing the link of bank “A.”

Push **[BANK]** to select the memory bank mode

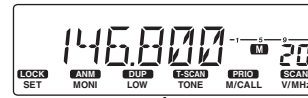

Rotate **[DIAL]** to select the desired bank.



Push **[SET]** to enter the Set mode.

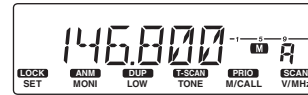

Push **[SET]** or **[MONI]** to select the “BAK” item.



Rotate **[DIAL]** to select “--.”

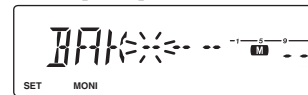

[i.e.]: Erasing the link of bank A.

Push **[BANK/OPTION]** to select the memory bank mode.

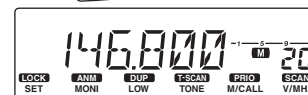

Push **[▲]**/**[▼]** to select the desired bank.

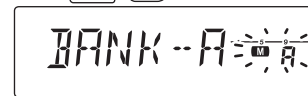

Push **[D-OFF SET B]** to enter the Set mode.

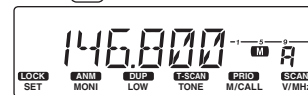

Push **[D-OFF SET B]**/**[T-OFF ENT C]** to select the “BAK” item.

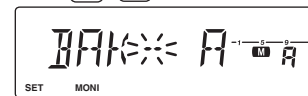

Push **[▲]**/**[▼]** to select “--.”

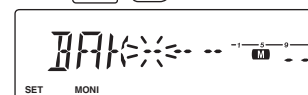



Call channel selection

- ➔ Push **[M/CALL]** once or twice to select the Call channel.
 - “C” appears instead of a memory channel number.
 - Push **[M/CALL]** to return to the memory mode, or push **[V/MHz]** to select the VFO mode.

✓ INFORMATION

When the VFO mode is selected from the Call channel, a small “c” appears instead of memory channel number.

Using the HM-133V







- ➔ Hold down **[CALL]**  for 1 second to select the Call channel.
 - Push **[MR]**  to select the memory mode, or push **[VFO]**  to select the VFO mode.

Copying Call channel contents

The contents of Call channel can be copied to another channel or to the VFO.

- ➊ Push **[M/CALL]** one or more times to select the Call channel.
 - “C” appears.
- ➋ To copy the Call channel contents to a Memory channel, push **[MW]** (S.MW), and then rotate **[DIAL]** to select the memory channel to be copied.
 - The “M” icon and memory channel number blink.
- ➌ Hold down **[MW]** (S.MW) for 1 second to copy.
 - If channel names have been programmed into the Call channel, the names are also copied.
 - To copy to the VFO, hold down **[MW]** (S.MW) for 1 second.

Using the HM-133V

- ➊ Hold down **[CALL]**  for 1 second to select the Call channel.
- ➋ Push **[FUNC]** , then **[MW]** , and then push **[▲]** or **[▼]** to select the memory channel to copy the contents.
- ➌ Push **[FUNC]** , then hold down **[MW]**  for 1 second to copy when a momentary push was used in the previous step.
 - If channel names have been programmed into the Call channel, the names are also copied.
 - To copy to the VFO, push **[FUNC]** , and then hold down **[MW]**  for 1 second.

Push **[M/CALL]** once or twice to select the Call channel.

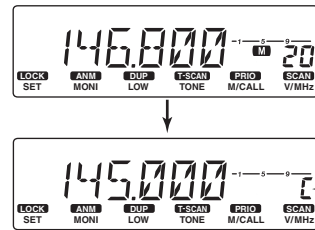

Appears

Hold down **[MR/CALL]**  for 1 second to select the Call channel.

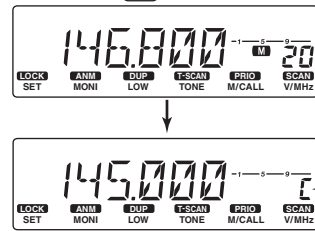

Appears

[i.e.]: Copying the Call channel (145.000 MHz) to memory channel 2.

Push **[S.MW]**.

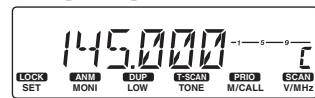

Rotate **[DIAL]** to select the memory channel.

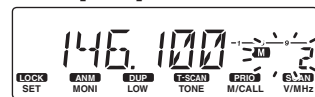

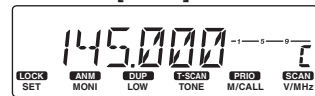

The selected memory channel.

Hold down **[S.MW]** for 1 second.



[i.e.]: Copying the Call channel (145.000 MHz) to memory channel 2.

Push **[FUNC]**  then **[MW CLR A]** .

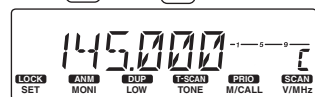

Push **[▲]** / **[▼]** to select the memory channel.

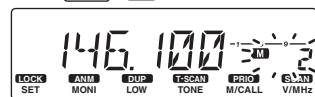

The selected memory channel.

Push **[FUNC]** , then hold down **[MW CLR A]**  for 1 second.

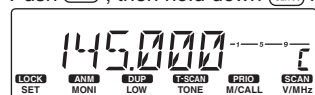

■ Programming a Call channel

Operating frequency, **duplex** setting, subaudible tone setting (tone encoder or **tone squelch** ON/OFF and its frequency) and channel names can be also programmed into the Call channel.

- ① Push **[V/MHz]** to select the VFO mode, and set the desired frequency.
- ② Push **[MW]** (S.MW).
- ③ Rotate **[DIAL]** to select the Call channel
 - The “**M**” icon and “**C**” blink.
- ④ Hold down **[MW]** (S.MW) for 1 second
 - 3 beeps sound, and then the transceiver automatically returns to the VFO mode.

[i.e.]: Programming 145.120 MHz into the Call channel.

Push **[V/MHz]** to select the VFO mode.

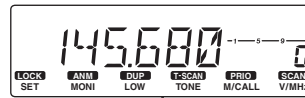

Rotate **[DIAL]** to set the frequency.

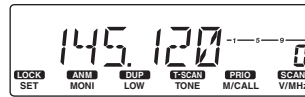

Push **[M/CALL]**, and then push **[S.MW]**.

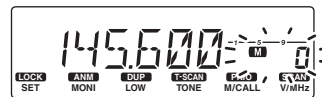

Rotate **[DIAL]** until large “**C**” appears.

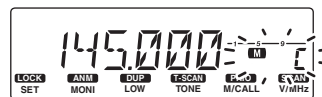

Hold down **[MW]** (S.MW) for 1 second.

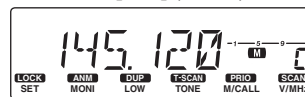

Beep♪ Beep♪ Beep♪

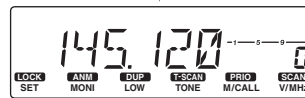

Using the HM-133V

- ① Set the desired frequency in the VFO mode.
 - ➔ Push **[VFO]** (VFO/LOCK) to select the VFO mode.
 - ➔ Set the frequency.
 - ➔ Set other data as desired.
- ② Push **[FUNC]** (FUNC), and then **[MW]** (MW CLR A).
- ③ Push **[▲]** or **[▼]** to select the Call channel.
- ④ Push **[FUNC]** (FUNC) then **[MW]** (MW CLR A) for 1 second to program.
 - 3 beeps sound, and then the transceiver automatically returns to the VFO mode.

[i.e.]: Programming 145.120 MHz into the Call channel using the microphone.

Push **[VFO/LOCK]** to select the VFO mode.

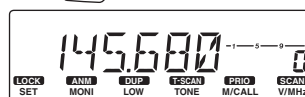

Push **[T-OFF ENT C]**, **[ANIM MON1]**, **[DTC5 HIGH4]**, **[DTC5 MD 5]**, **[ANIM MON1]**, **[TSCAN SCAN2]**, **[TONE2 VOL40]** to set the frequency.

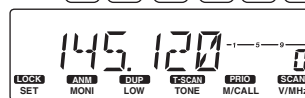

Push **[FUNC]**, and then push **[MW CLR A]**.

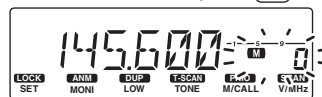

Push **[▲]** / **[▼]** until large “**C**” appears.

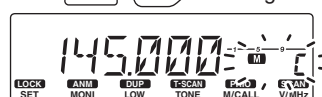

Push **[FUNC]** then hold down **[MW CLR A]** for 1 second.

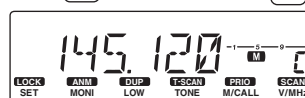

Beep♪ Beep♪ Beep♪

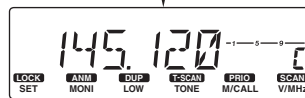

Scan types

Scanning automatically searches for signals making it easier to locate new stations for contact or listening purposes.

There are 3 scan types and 4 resume conditions to suit your operating needs.

FULL SCAN

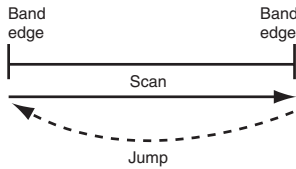

Repeatedly scans all frequencies over the entire band. Used as the simplest scan without any preliminary settings.

PROGRAMMED SCAN

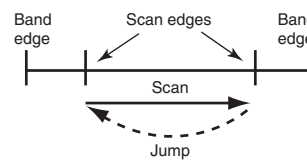

Repeatedly scans between two programmed frequencies. Used to checking for frequencies within a specified range, such as **repeater** output frequencies, and so on. 3 pairs of **scan edges** are programmable.

MEMORY SCAN

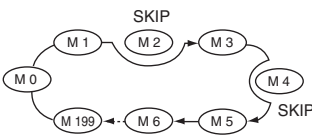

Repeatedly scans memory channels, except those set as skip channels. Used for often-called channels and for bypassing normally busy channels such as **repeater** frequencies.

SCAN RESUME FUNCTION (p. 33)

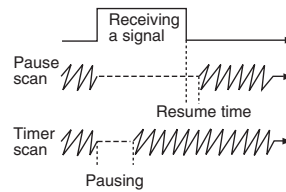

11 pause options and 7 timer options are selectable. When receiving a signal, the pause scan pauses until the signal disappears; timer scan pauses for the specified period of time.

NOTE: A tone scan function is selectable to search for subaudible tones (Example: When you want to find a subaudible tone frequency that is necessary to open a **repeater**). See page 42 for details.

■ Scan start/stop

◇ Preparation

If desired, set the scan resume option (p. 33), program the **scan edges** (p. 31), program 2 or more memory channels (p. 17), set the skip channels (p. 32).

◇ Operation

- ① Select the mode or bank.
 - For full/programmed scan:**
 - ➔ Push [V/MHz] to select the VFO mode.
 - For memory scan:**
 - ➔ Push [M/CALL] to select the memory mode.
 - For bank scan:**
 - ➔ Push [BANK], and then rotate [DIAL] to select the desired bank.
- ② Set the squelch to the point where the noise is just muted.
- ③ Hold down [SCAN] (V/MHz) for 1 second to start the scan.
 - Rotate [DIAL] to change the scanning direction.
 - The scan type blinks in the memory channel read-out.
- ④ Push [SET] to switch between a full scan and a programmed scan (P1, P2 and P3).
 - Push [V/MHz] to cancel the scan.

[i.e.]: Starting a memory scan.

Push [M/CALL].

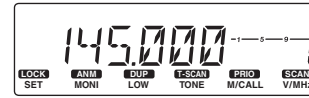

Hold down [SCAN] (V/MHz) for 1 second.

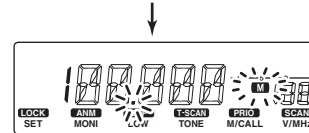
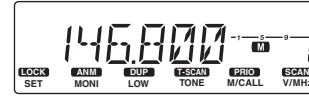

During memory scan

• During a full scan

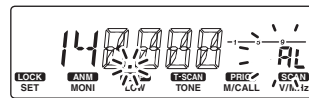

Push [SET] to select a full, band or programmed scan (P1, P2 and P3) in sequence.

• During a programmed scan

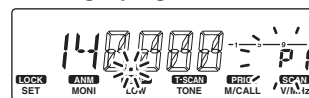

Scan edge channel display.
 • P1 stands for 1A/1b
 • P1 to P3 are selectable when they are programmed, and switched with [SET].

• During a memory or bank scan

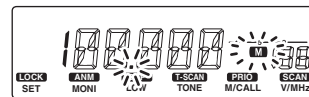

Using the HM-133V

- 1 Select the mode or bank.
 - For a full/programmed scan:**
 - ➔ Push [VFO] (VFO/LOCK) to select the VFO mode.
 - For a memory scan:**
 - ➔ Push [MR] (MR/CALL) to select the memory mode.
 - For a bank scan:**
 - ➔ Push [BANK] (BANK/OPTION), and then push [▲] or [▼] to select the desired bank.
- 2 Set the squelch to the point where noise is just muted.
- 3 Push [SCAN] (TSCAN/SCAN2) to start the scan.
 - Hold down [▲] or [▼] for 1 second also starts the scan.
- 4 Push [SET] (D-OFF/SET B) to switch between a full scan and programmed scan (P1, P2 and P3).
- 5 Push [SCAN] (TSCAN/SCAN2) or [CLR] (MW CLR A) to stop the scan.

[i.e.]: Starting a memory scan.

Push [MR/CALL].

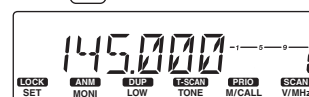

Push [TSCAN/SCAN2].

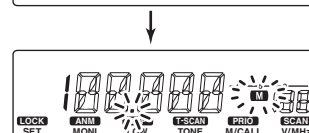
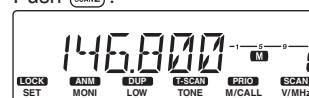

During memory scan

Scan edges programming

Scan edges can be programmed in the same manner as memory channels. Scan edges are programmed into scan edges, 1A/1b to 3A/3b, in memory channel sheet.

- ① Set the desired edge frequency in the VFO mode:
- ② Push **[MW]** (S.MW).
 - The “**M**” icon and channel number blink.
- ③ Rotate **[DIAL]** to select one of scan edge channels, 1A, 2A or 3A.
- ④ Hold down **[MW]** (S.MW) for 1 second.
 - 3 beeps sound and the transceiver automatically returns to the VFO mode.
 - Scan edge 1b, 2b or 3b is automatically selected when continuing to hold down **[MW]** (S.MW) after programming.
- ⑤ To program a frequency for the other pair of scan edges, the 1b, 2b or 3b, repeat steps ① through ④.
 - If the same frequency is programmed into a pair of scan edges, the programmed scan cannot start.

Using the HM-133V

- ① Set the desired frequency in the VFO mode.
- ② Push **[FUNC]** **[FUNC]**, and then **[MW]** **[MW CLR A]**.
- ③ Push **[▲]** or **[▼]** to select the scan edge channels, 1A, 2A or 3A.
- ④ Push **[FUNC]** **[FUNC]**, and then hold down **[MW]** **[MW CLR A]** for 1 second.
 - 3 beeps sound and the VFO mode is automatically selected.
 - The memory channel number advances to the next scan edge channel, 1b, 2b or 3b, when continuing to push **[MW]** **[MW CLR A]** after programming.
- ⑤ To program a frequency for the other scan edge channels, repeat steps ① to ④.

[i.e.]: Programming 145.300 MHz into scan edge 1A.

Push **[V/MHz]**.

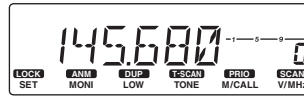

Rotate **[DIAL]** to set the frequency.

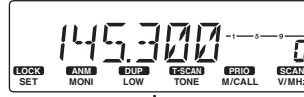

Push **[S.MW]**.

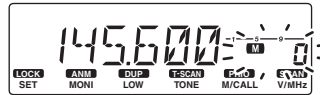

Rotate **[DIAL]** to select the scan edge channel.

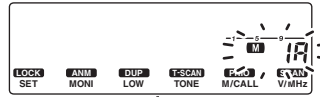

Hold down **[MW]** (S.MW) for 1 second.

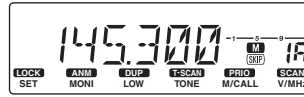

Beep Beep Beep

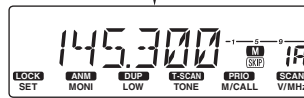

[i.e.]: Programming 145.800 MHz into scan edge 1b.

Push **[VFO/LOCK]**.

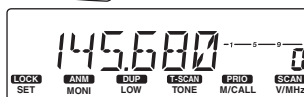

Push **[T-OFF ENT C]** **[ANM MON1]** **[DTCS HIGH 4]** **[DTCS-HIGH 5]** **[TSQL-DUP-B]** **[TONE-2 VOL10]** **[TONE-2 VOL10]**.

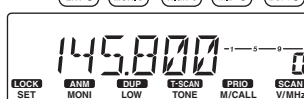

Push **[FUNC]** then **[MW CLR A]**.

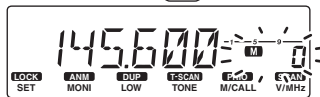

Push **[▲]** / **[▼]**.

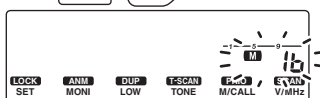

Push **[FUNC]** then hold down **[MW CLR A]** for 1 second.

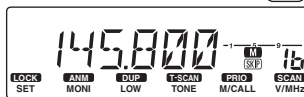

Beep Beep Beep

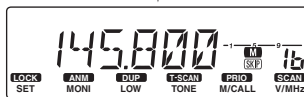

■ Skip channel setting

The memory skip function speeds up **scanning** by not scanning those memory channels set as skip channels. Set skip channels as follows.

- ① Push **[M/CALL]** to select the memory mode, and then select the memory channel to be skipped.
- ② Push **[SET]** to enter the Set mode.
- ③ Push **[SET]** or **[MONI]** until "CHS" appears.
- ④ Rotate **[DIAL]** to select "ON."
 - "SKIP" appears : The channel is skipped while scanning.
- ⑤ Push any key other than **[SET]** or **[MONI]**, to exit the Set mode.

[i.e.]: Setting memory channel 20 as the skip channel.

Push **[SET]** to enter the Set mode.

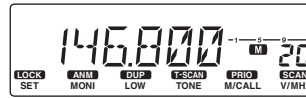





Push **[SET]** or **[MONI]** to select the "CHS" item.



Rotate **[DIAL]** to select "ON."





Using the HM-133V

- ① Push **[MR]**  to select the memory mode, and then push **[▲]** or **[▼]** to select the channel to be skipped.
- ② Push **[SET]**  to enter the Set mode.
- ③ Push **[SET]**  or **[ENT]**  until "CHS" appears.
- ④ Push **[▲]** or **[▼]** to select "ON."
- ⑤ Push **[CLR]**  to save the selection and exit the Set mode.

[i.e.]: Setting memory channel 20 as the skip channel, using the HM-133V.

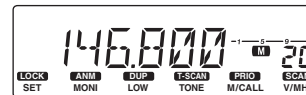
Push  to enter the Set mode.





Push  /  to select the "CHS" item.

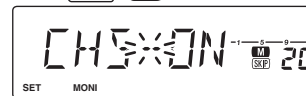

Push  /  to select "ON."



NOTES:

The Set mode cannot be accessed when memory names are displayed. To set the skip option, return to the frequency display by holding down **[MONI]** (ANM) on the front panel for 1 second, or push **[FUNC]**  then **[MONI]**  (on the HM-133V) to cancel the channel name display, and then set the Skip function as described above.

■ Scan Resume function

Various pause and timer options can be selected with the Scan Resume function. The selected resume option is also used for **Priority Watch**. (p. 35)

- ① Push **[SET]** to enter the Set mode.
- ② Push **[SET]** or **[MONI]** until “SCT” or “SCP” appears.
- ③ Rotate **[DIAL]** to set the desired timer:
 - “SCP-2”-“SCP-20” : The scan pauses for 2 to 20 seconds, when a signal is received.
 - “SCP-HO” : When a signal is received, the scan pauses until it disappears.
 - “SCT-0”-“SCT-5” : The scan pauses, then resumes 0 to 5 seconds after the signal disappears.
 - “SCT-HO” : The scan continues to pause, even if the signal disappears.
- ④ Push any keys other than **[SET]** or **[MONI]** to exit the Set mode.

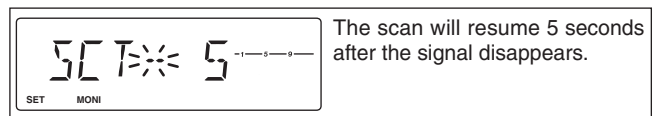
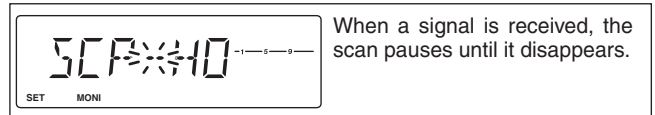

Using the HM-133V

- ① Push **[SET]** D-OFF SET B to enter the Set mode.
- ② Push **[SET]** D-OFF SET B or **[ENT]** T-OFF ENT C until “SCT” or “SCP” appears.
- ③ Push **[▲]** or **[▼]** to select the scan resume option.
 - See step ③ above for details.
- ④ Push **[CLR]** MW CLR A to exit the Set mode.

NOTE: The Set mode cannot be accessed when memory names are displayed. To set the scan resume option, return to the frequency display by holding down **[MONI]** (ANM) on the front panel for 1 second, or push **[FUNC]** FUNC then **[MONI]** ANM MONI (on the HM-133V) to cancel the channel name display, and then set the option as described on above.

Priority Watch types

IC-2300H has three types of **Priority Watch**, to suit your needs. You can transmit on the **VFO** frequency, even while Priority Watch is functioning.

The watch resumes, depending on the selected scan resume function. See the page 33 for details.

NOTE: If the **pocket beep** function is activated, the transceiver automatically turns ON the **Tone Squelch** function, when Priority Watch starts.

MEMORY CHANNEL WATCH

While operating on a VFO frequency, Priority Watch checks for a signal on the selected memory channel every 5 seconds.

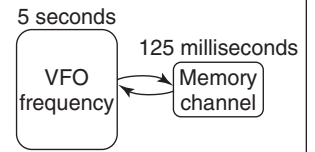

MEMORY SCAN WATCH

While operating on a VFO frequency, Priority Watch sequentially checks for signals on each memory channel.

- The memory skip function is useful to speed up the scan.

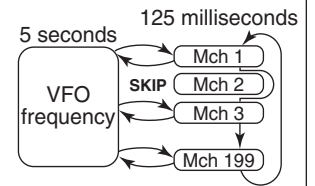

CALL CHANNEL WATCH



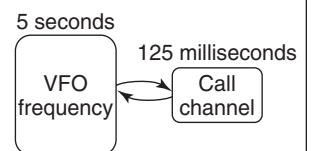





While operating on a VFO frequency, Priority Watch checks for signals on the Call channel every 5 seconds.



■ Priority watch operation

- ① Select the VFO mode, and then set the operating frequency.
- ② Set the watching channel.
 - For a memory channel watch:**
Push [M/CALL] to select the memory mode, and then rotate [DIAL] to select the desired memory channel.
 - For a memory scan watch:**
Select the memory mode, and then hold down [SCAN] (V/MHz) for 1 second to start the memory scan.
 - For a Call channel watch:**
Push [M/CALL] once or twice, to select the Call channel.
- ③ Hold down [M/CALL] (PRIO) for 1 second to start the priority watch.
 - The “PRIO” icon appears.
 - The transceiver checks the memory channel or Call channel every 5 seconds.
 - When a signal is received on the priority channel, the watch pauses.
 - The watch resumes depending on the selected scan resume condition. (p. 33)
 - When the watch is paused, push [M/CALL] to manually resume it.
- ④ Push [M/CALL] to cancel the Priority Watch.
 - The transceiver automatically returns to the VFO mode.

Using the HM-133V

- ① Select the VFO mode, and then set the operating frequency.
- ② Set the watching channel.
 - For a memory channel watch:**
Push [MR]  then [▲] or [▼], to select the desired memory channel.
 - For a memory scan watch:**
Push [MR] , and then push [SCAN]  to start the memory scan.
 - For a call channel watch:**
Hold down [CALL]  for 1 second to select the Call channel.
- ③ Push [PRIO]  to start the watch.
 - The transceiver checks the memory or Call channel every 5 seconds.
 - The watch resumes depending on the selected scan resume option. (p. 33)
 - When the watch is paused, push [PRIO]  or [CLR] , to manually resume it.
- ④ Push [CLR]  to cancel the watch.

[i.e.]: The memory channel watch on memory channel 20.

Push [M/CALL].

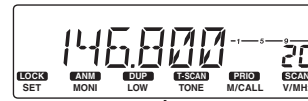

Rotate [DIAL] to select the desired memory channel.

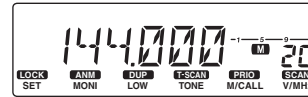

Hold down [PRIO] (M/CALL) for 1 second.

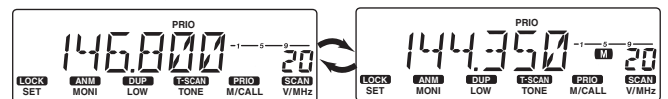
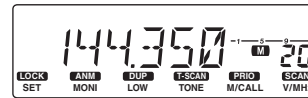

The watch checks for a signal on memory channel 20, every 5 seconds.

[i.e.]: The memory channel watch on memory channel 20.

Push .

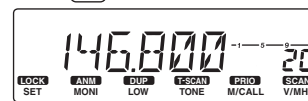

Push  to select the desired memory channel.

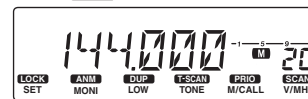

Push .

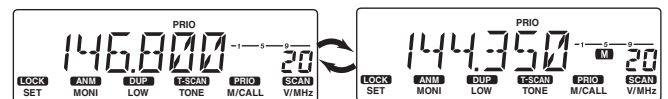
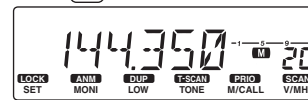

The watch checks for a signal on memory channel 20, every 5 seconds.

■ Programming a DTMF code

DTMF codes are used for autopatching, controlling other equipment, and so on. IC-2300H has up to 16 DTMF memory channels (d0–dF) for up to 24 digits often-used DTMF codes.

- ① Hold down **[OPT]** (BANK) for 1 second to enter the Option Set mode.
- ② If necessary, push **[SET]** or **[MONI]** to select “DTM.”
- ③ Rotate **[DIAL]** to turn ON the DTMF encoder.
- ④ Push **[BANK]** to enter the DTMF memory mode.
 - The DTMF memory channel display blinks.
 - If desired, push **[BANK]** again to return to the Option Set mode.
- ⑤ Rotate **[DIAL]** to select a desired blank DTMF memory channel.
 - The DTMF memory channel display blinks.
- ⑥ Push **[SET]** or **[MONI]** to enter the DTMF memory programming mode.
 - The first digit (–) blinks.
- ⑦ Rotate **[DIAL]** to select the desired character.
- ⑧ Push **[MONI]** to set the character and select the next digit.
 - Push **[SET]** to move the cursor to the left, push **[MONI]** to move the cursor to the right.
- ⑨ Repeat steps ⑦ and ⑧, to set the desired DTMF code sequence.
 - When the 6th character is set, the indicator displays the next blank digit group.
- ⑩ Push any key other than **[SET]** or **[MONI]**, to save the channel and exit the DTMF memory programming mode.

Using the HM-133V

- ① Hold down **[OPTION]** (BANK/OPTION) for 1 second to enter the Option Set mode.
- ② If necessary, push **[MR]** (MR/CALL) to select “DTM.”
- ③ Push **[▲]** to turn ON the DTMF encoder.
- ④ Push **[SET]** (D-OFF/SET B) to enter the DTMF memory mode.
 - If desired, push **[OPTION]** (BANK/OPTION) to return to the Option Set mode.
- ⑤ Push **[▲]** or **[▼]** to select a desired blank DTMF memory channel.
 - The DTMF memory channel display blinks.
- ⑥ Sequentially push the keys (0–9 or A to F), to set the desired DTMF code sequence.

A: [A] (MW/CLR A)	B: [B] (D-OFF/SET B)
C: [C] (T-OFF/ENT C)	D: [D] (MUTE/SOL/D)
E: [*] (TONE-/VOL+)	F: [#] (KEY-/SOLY#)

 - When the 6th character is set, the indicator displays the next blank digit group.
- ⑦ Push **[▲]** or **[▼]** to save the channel.
- ⑧ Push **[VFO]** (VFO/LOCK) to exit the DTMF memory programming mode.

[i.e.]: Programming “5428AB453” into the DTMF memory channel “d4.”

Hold down **[OPT]** (BANK) for 1 second.



Rotate **[DIAL]** to turn ON the DTMF encoder.



Push **[BANK]**.

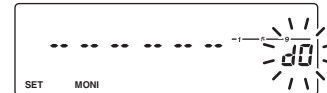

Rotate **[DIAL]**.

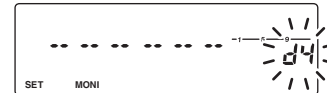

Push **[SET]**, and then rotate **[DIAL]**.

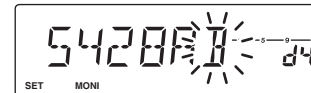

Repeat until the code is complete.

Push any key other than **[SET]** or **[MONI]**.

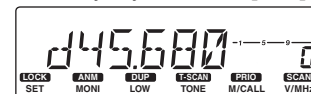

[i.e.]: Programming “54A2F” into the DTMF memory channel “d4.”

Push **[MR/CALL]** once or twice.



Push **[▲]** to turn ON the DTMF encoder.

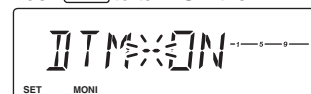

Push **[D-OFF/SET B]**.



Push **[▲]** / **[▼]** to select the desired blank channel.

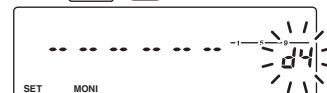

Sequentially push **[DTCB=MD 5]**, **[DTCB=HG H4]**, **[MW/CLR A]**, **[TSCAN/SCAN2]**, **[KEY-/SOLY#]**.

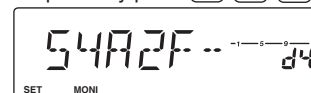

Push **[VFO/LOCK]**.



■ Transmitting a DTMF code

◇ Automatic transmission (DTMF memory)

- ① Hold down [OPT] (BANK) for 1 second to enter the Option Set mode.
- ② If necessary, push [SET] or [MONI] to select “DTM.”
- ③ Rotate [DIAL] to turn ON the DTMF encoder.
- ④ Push [BANK] to enter the DTMF memory mode.
 - The DTMF memory channel display blinks.
 - If desired, push [BANK] again to return to the Option Set mode.
- ⑤ Rotate [DIAL] to select a desired blank DTMF memory channel.
- The DTMF memory channel display blinks.
- ⑥ Push any key other than [SET] or [MONI], to save the selection and exit the DTMF memory mode.
 - “d” appears in the 100 MHz digit.
- ⑦ Push [PTT].
 - The selected DTMF code is transmitted.

◇ Transmitting a DTMF memory using the HM-133V

- ① Push [FUNC] (FUNC) then [DTMF] (DTMF) to turn ON the DTMF memory encoder.
 - “d” appears in the 100 MHz digit.
 - ② Push [DTMF-S] (DTMF-S) to turn ON the DTMF memory direct selection.
 - The function LED on the microphone lights green.
 - ③ Push a desired DTMF channel number.
 - The selected DTMF code is automatically transmitted without pushing [PTT].
- NOTE:** When the pushed channel number is not assigned a DTMF code, the previously transmitted DTMF memory code is transmitted.
- ④ Push [DTMF-S] (DTMF-S) again to turn OFF the DTMF memory direct selection.
 - The function LED on the microphone goes out.
 - ⑤ Push [FUNC] (FUNC) then [D-OFF] (D-OFF) to turn OFF the DTMF memory encoder.

◇ Manual transmission using the HM-133V

- ① If necessary, push [FUNC] (FUNC) then [D-OFF] (D-OFF) to turn OFF the DTMF memory encoder.
- ② Push [DTMF-S] (DTMF-S) to turn ON the DTMF direct selection.
 - The function LED on the microphone lights green.
- ③ Push one of A to F keys, and then push the desired DTMF keys; 0–9 or A to F.

A: [A] (MW CLR A)	B: [B] (D-OFF SET B)
C: [C] (T-OFF ENT C)	D: [D] (MUTE SOLAD)
E: [*] (TONE VOL+)	F: [#] (TKEY1 SOL#)

 - Automatically transmits without pushing [PTT].
 - The first code entered may not be transmitted because transmitting takes 400 milliseconds to start. Then the DTMF code transmission starts from the 2nd code.
- ④ Push [DTMF-S] (DTMF-S) again to turn OFF the DTMF direct selection.
 - The function LED on the microphone goes out.

[i.e.]: Transmitting the DTMF code in the DTMF memory channel “d4.”

Hold down [OPT] (BANK) for 1 second.

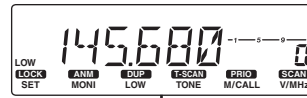

Rotate [DIAL] to turn ON the DTMF encoder, and then push [BANK].



Rotate [DIAL], and then push any key other than [SET] or [MONI].



Push [PTT].

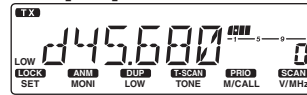

Transmitting the DTMF code.

[i.e.]: Transmitting the DTMF code in the DTMF memory channel “d4.”

Push [FUNC] then [DTMF].

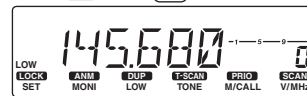

Push [DTMF-S], and then push a desired DTMF channel number.

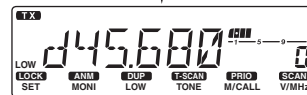
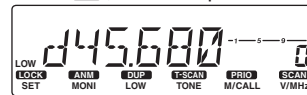

Transmitting the DTMF code.

[i.e.]: Transmitting the DTMF code “54A2F.”

Push [DTMF-S] and then, sequentially push [DTCH] (MD 5), [DTCS] (HIGH 4), [MW CLR A], [SCAN] (SCAN2), [TKEY1] (SOL#).

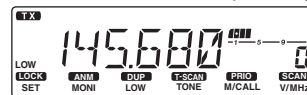

Transmitting the DTMF code.

■ DTMF TX speed

The transmitting speed of **DTMF** code can be set to accommodate your operating needs.

- ① Hold down **[⏻]** for 1 second to turn OFF the power.
- ② While holding down **[LOCK]** (SET) and **[⏻]** for 1 second, to turn ON the power to enter the Initial Set mode.
- ③ Push **[SET]** or **[MONI]** until “DTD” appears.
- ④ Rotate **[DIAL]** to select the desired transmitting speed, as shown in the table below.
- ⑤ Push **[⏻]** to exit the Initial Set mode.

DISPLAY	INTERVAL	SPEED
DTD- 1	100 milliseconds	5.0 cps
DTD- 2	200 milliseconds	2.5 cps
DTD- 3	300 milliseconds	1.6 cps
DTD- 5	500 milliseconds	1.0 cps

cps=characters/second



The display shows the fastest DTMF speed is selected.

■ Pocket beep operation

This function uses subaudible tones as calling, and can be used as a “common pager” to inform you that someone has called while you were away from the transceiver.

◇ Waiting for a call from the specific station

- ① Set the operating frequency.
- ② Push **[SET]** to enter the Set mode.
- ③ Set the tone frequency, or **DTCS** code and DTCS polarity.
- ④ Push any key other than **[SET]** or **[MONI]** to exit the Set mode.
- ⑤ Push **[TONE]** one or more times until “**!**” or “**!** **!**” is displayed, to respectively turn ON the pocket beep with **tone squelch** or DTCS squelch.
- ⑥ When a signal with the matched tone is received, beep tones and the “**!**” icon blinks.
 - The beeps sound for 30 seconds and the “**!**” icon blinks. To manually stop the beeps and blinking, push any key. When the beep tones are not manually stopped, the “**!**” icon continues blinking until **[PTT]** is pushed.
- ⑦ Push **[PTT]** to answer.
 - The “**!**” icon disappears and automatically cancels the pocket beep function.
- ⑧ Push **[TONE]** one or more times until the “**!**” icon or the “**!**” icon disappears, to cancel the tone or the DTCS Squelch function.

Using the HM-133V

- ① Set the operating frequency.
- ② Push **[SET]** (D-OFF SET B) to enter the Set mode.
- ③ Set the tone frequency, or DTCS code and DTCS polarity.
 - Push **[CLR]** (MW CLR A) to exit the Set mode.
- ④ Push **[FUNC]** (FUNC), and then push **[TSQL (••)]** (TSQL=•• DUP=8) or **[DTCS (••)]** (DTCS=•• MD=5), to respectively turn ON the pocket beep with tone squelch or DTCS squelch.
- ⑤ When the matched tone is received, the transceiver emits the beep tones for 30 seconds and the “**!**” icon blinks.
- ⑥ Push **[PTT]** to replay, or push **[CLR]** (MW CLR A) to stop the beeps and flashing.
 - The “**!**” icon automatically disappears and cancels the pocket beep function.
- ⑦ To cancel the tone squelch or DTCS Squelch function, push **[FUNC]** (FUNC) then **[T-OFF]** (T-OFF ENT C).
 - The “**!**” icon or “**!**” icon disappears

Push **[SET]** to enter the Set mode.

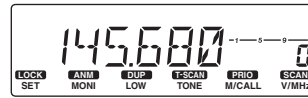

Push **[SET]** or **[MONI]** to select the item, and then rotate **[DIAL]** to set the option or value.

Setting the tone frequency

Setting the DTCS code

Setting the DTCS polarity

Push any key other than **[SET]** or **[MONI]** to exit the Set mode.

Push **[TONE]** one or more times to turn ON the Pocket Beep function.

Appears when the pocket beep with tone squelch is activated.

Appears when the pocket beep with DTCS squelch is activated.

When a signal with the matched tone is received...

Beep♪ Beep♪ Beep♪

Push **[D-OFF SET B]** to enter the Set mode.

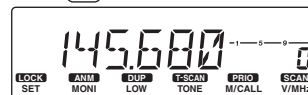

Push **[D-OFF SET B]** / **[T-OFF ENT C]** to select the item, and then push **[▲]** / **[▼]** to set the option or value.

Setting the tone frequency

Setting the DTCS code

Setting the DTCS polarity

Push **[MW CLR A]** to exit the Set mode.

Push **[FUNC]** then **[TSQL=•• DUP=8]** or **[DTCS=•• MD=5]** to turn ON the Pocket Beep function.

Appears when the pocket beep with tone squelch is activated.

Appears when the pocket beep with DTCS squelch is activated.

10 POCKET BEEP AND TONE SQUELCH

◇ Waiting for a call from the specific station (continued)

• **Selectable tone frequencies** (unit: Hz)

67.0	79.7	94.8	110.9	131.8	156.7	171.3	186.2	203.5	229.1
69.3	82.5	97.4	114.8	136.5	159.8	173.8	189.9	206.5	233.6
71.9	85.4	100.0	118.8	141.3	162.2	177.3	192.8	210.7	241.8
74.4	88.5	103.5	123.0	146.2	165.5	179.9	196.6	218.1	250.3
77.0	91.5	107.2	127.3	151.4	167.9	183.5	199.5	225.7	254.1

/// **NOTE:** IC-2300H has 50 tone frequencies and their spacing is consequently narrow, compared to units having 38 tones. Therefore, some tone frequencies may receive interference from adjacent tone frequencies.

◇ **Calling a waiting station using pocket beep**

A subaudible tone matched with the station's **CTCSS** tone frequency or 3-digit **DTCS** code with polarity is necessary. Use the **tone squelch** on the next page or a subaudible tone encoder. (pp. 13, 41)

■ Tone/DTCS squelch operation

The **tone squelch** or **DTCS squelch** opens when a signal with the same pre-programmed subaudible tone or DTCS code is received.

The reverse tone or DTCS squelch is convenient when you want to ignore the specific signal. The transceiver closes the squelch when a signal with the same pre-programmed subaudible tone or code is received.

- ① Set the operating frequency.
- ② Push **[SET]** to enter the Set mode.
- ③ Set the tone frequency, or DTCS code and DTCS polarity. (p. 45)
- ④ Push any key other than **[SET]** or **[MONI]** to exit the Set mode.
- ⑤ Push **[TONE]** one or more times to select the desired tone or code.
 - “**▷**” : Tone squelch
 - “**◻**” : DTCS squelch
 - “**▷-R**” : Reverse tone squelch
 - “**◻-R**” : Reverse DTCS squelch
- ⑥ Operate the transceiver in the normal way; push **[PTT]** to transmit; release **[PTT]** to receive.
 - To manually open the squelch, push **[MONI]**.

When the tone or DTCS is in use:
When a matched tone is received, the squelch opens and audio is heard.

 - If the signal includes an unmatched tone, the squelch does not open. However, the S/RF meter shows the signal strength.

When the reverse tone or DTCS is in use:
When a matched tone is received, the squelch remains closing.

 - If the signal includes a matched tone, the squelch does not open. However, the S/RF meter shows the signal strength.
- ⑦ To cancel the tone or DTCS squelch, push **[TONE]** one or more times, until the tone icon disappears.

Using the HM-133V

- 1 Set the operating frequency.
- 2 Program the **CTCSS** tone frequency or **DTCS** code in the Set mode. (p. 45)
- 3 Push **[FUNC]** **[FUNC]** then **[TSQL]** **[TSQL]** or **[DTCS]** **[DTCS]**, to turn ON the tone squelch or DTCS squelch.
- 4 When a matched tone is received, the squelch opens and audio is heard.
 - If the signal includes an unmatched tone, the squelch does not open. However, the S/RF meter shows the signal strength.
 - To manually open the squelch, push **[MONI]** **[MONI]**.
- 5 Operate the transceiver in the normal way; push **[PTT]** to transmit; release **[PTT]** to receive.
- 6 To cancel the tone squelch, push **[FUNC]** **[FUNC]** then **[T-OFF]** **[T-OFF]**.
 - The “**▷**” icon or “**◻**” icon disappears

Push **[SET]** to enter the Set mode.

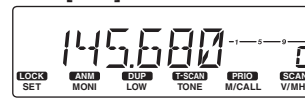

Push **[SET]** or **[MONI]** to select the item, and then rotate **[DIAL]** to set the option or value.

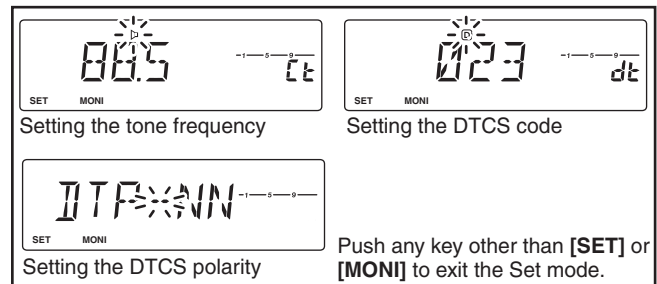

Push **[TONE]** one or more times to turn ON the tone squelch or DTCS.

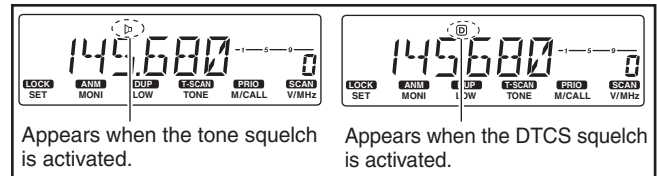

10

Push **[D-OFF SET B]** to enter the Set mode.

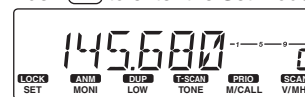

Push **[D-OFF SET B]** / **[T-OFF ENT C]** to select the item, and then push **[▲]** / **[▼]** to set the option or value.

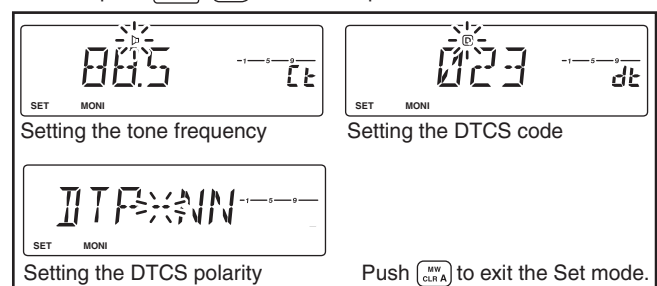

Push **[FUNC]** then **[TSQL-DUP-B]** or **[DTCS-MB-5]** to turn ON the tone squelch or DTCS.

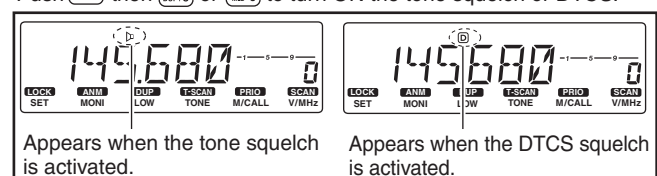

41

Tone scan

By monitoring a signal that is being operated with the **pocket beep**, tone or **DTCS** Squelch function turned ON, you can determine the tone frequency or DTCS code necessary to open the squelch.

- ① Set the channel to be checked for a tone frequency or code.
- ② Push **[TONE]** one or more times to select the tone type to be checked.
 - One of the icons “♪”, “D” or “D” appear.
- ③ Hold down **[T-SCAN]** (TONE) for 1 second to start the tone scan.
 - Rotate **[DIAL]** to change the scanning direction.
- ④ When the **CTCSS** tone frequency or DTCS code is detected, the squelch opens and the detected tone frequency is temporarily programmed into the memory or Call channel.
 - The scan pauses when a CTCSS tone frequency or DTCS code is detected.
 - The detected CTCSS tone frequency or DTCS code is used for the tone encoder or decoder, depending on the tone condition or type selected in step ②.
 - No icon : Cannot be used for operation.
 - “♪” : CTCSS tone encoder
 - “♪”+“D” : DTCS tone encoder
 - “D” : CTCSS tone encoder/decoder
 - “D” : DTCS tone encoder/decoder
- ⑤ Push **[V/MHz]** to cancel the scan.

[i.e.]: Checking for the tone frequency on the 145.680 MHz.

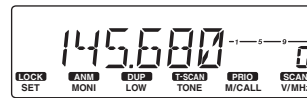

Push **[TONE]** one or more times to select the tone type.

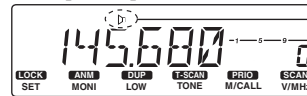

Appears

Hold down **[T-SCAN]** (TONE) for 1 second.

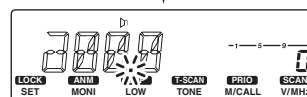
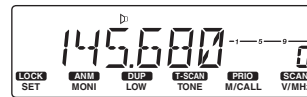

During CTCSS tone scan

Using the HM-133V

- ① Set the channel to be checked for a tone frequency.
- ② Select the tone type to be checked.
 - Push **[FUNC]** (FUNC) then push; **[TONE]** (TONE) for repeater tone; **[TSQL]** (TSQL) for tone squelch; **[DTCS]** (DTCS) for DTCS squelch.
- ③ Push **[FUNC]** (FUNC) then **[T-SCAN]** (TSCAN) to start the tone scan.
- ④ When the tone frequency is matched, the squelch opens and the tone frequency is programmed into the selected memory or Call channel.
- ⑤ Push **[CLR]** (CLR) to cancel the scan.

[i.e.]: Checking for the tone frequency on the 145.680 MHz.

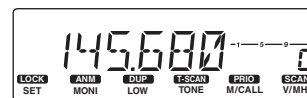

Push **[FUNC]** then **[TSQL]** to select the tone type.

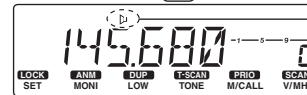

Appears

Push **[FUNC]** then **[TSCAN]**.

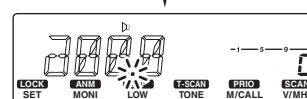
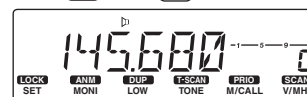

During CTCSS tone scan

NOTE: The detected tone frequency is temporarily programmed when a memory or Call channel is selected. However, this will be cleared when the memory or Call channel is re-selected.

■ Set mode

• Set mode operation

- ① Push [SET] to enter the **Set mode**.
- ② Push [SET] or [MONI] to select the desired item.
- ③ Rotate [DIAL] to set the option or value.
- ④ Push any key other than [SET] or [MONI], to exit the Set mode.

Using the HM-133V

- ① Push [SET] (D-OFF SET B) to enter the Set mode.
- ② Push [SET] (D-OFF SET B) or [ENT] (T-OFF ENT C), to select the desired item.
- ③ Push [▲] or [▼] to select the option or value.
- ④ Push [CLR] (MW CLR A) to exit the Set mode.







Set mode items		*Appears only when accessing the Set mode from the memory mode.	
↑: [MONI] ↓: [SET]	• Repeater tone frequency		Select the subaudible tone needed to access the repeater. p. 45
	• Tone squelch frequency		Select the CTCSS tone frequency for the tone squelch function. p. 45
	• DTCS code		Set the DTCS code for DTCS squelch operation. p. 45
	• DTCS polarity		Set the Transmit and Receive DTCS polarity. p. 45
	• Frequency offset		Set the duplex frequency offset. p. 45
	• Reverse mode		Turn the Reverse Duplex function ON or OFF p. 45
	• Tuning step		Set the VFO tuning step. p. 45
	• Scan stop timer		Select the scan pause timer option. p. 45
	• Scan resume timer		Select the scan resume options of a pause. p. 45
	• Display dimmer		Set the backlight brightness. p. 45
	• Auto dimmer		Set the Auto Dimmer brightness. p. 45

(Continued on page 44)

11 OTHER FUNCTIONS

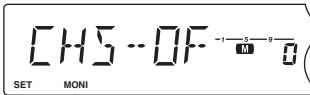
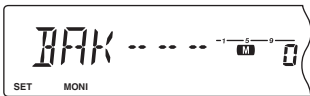
■ Set mode (continued)

[†]Appears only when accessing the Set mode from the memory mode.

▲: [MONI] ▼: [SET]	• Display color		Select the display backlight color. p. 46
	• Display contrast		Adjust the LCD contrast. p. 46
	• Transmit permission		Turns the TX inhibit function ON or OFF. p. 46
	• Channel skip setting [†]		Turns the Skip function ON or OFF. p. 46
	• Bank setting [†]		Assign the desired memory and scan edge channels. p. 46
	• Bank link function [†]		Assign the desired banks for a continuous banks scan. p. 46
	• Wide/Narrow		Set both the transmission and reception passband. p. 46
	• Weather alert (For only the USA version.)		Turn the weather Alert function ON or OFF. p. 46
	• MIC gain		Set the microphone sensitivity. p. 46

◇ Repeater tone

Select the subaudible tone needed to access the **repeater**. A total of 50 tone frequencies (67.0–254.1 Hz) are selectable. (default: 88.5 Hz)



◇ Tone squelch frequency

Select the **CTCSS** tone frequency to use for the Tone Squelch function.

A total of 50 tone frequencies (67.0–254.1 Hz) are selectable. (default: 88.5 Hz)



• Selectable subaudible tone frequencies

67.0	79.7	94.8	110.9	131.8	156.7	171.3	186.2	203.5	229.1
69.3	82.5	97.4	114.8	136.5	159.8	173.8	189.9	206.5	233.6
71.9	85.4	100.0	118.8	141.3	162.2	177.3	192.8	210.7	241.8
74.4	88.5	103.5	123.0	146.2	165.5	179.9	196.6	218.1	250.3
77.0	91.5	107.2	127.3	151.4	167.9	183.5	199.5	225.7	254.1

◇ DTCS code

Set the **DTCS** code (both encoder and decoder) for DTCS squelch operation. A total of 104 codes are selectable. (default: 023)



◇ DTCS polarity

Set the Transmit and Receive DTCS polarity to “NN,” “NR,” “RN” or “RR.” (default: NN)



◇ Frequency offset

Set the **duplex** frequency offset between 0 and 20 MHz. In the duplex mode, the transmit frequency shifts up or down from the receive frequency by the offset amount. (default: Depending on the transceiver versions)



◇ Reverse function

Turn the Reverse Duplex function ON or OFF (default). When the Reverse Duplex function is ON, the receive and transmit frequencies are reversed.

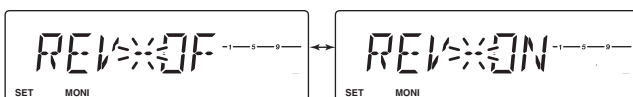

OFF: Normal duplex (default)

ON: Reversed duplex

◇ Tuning step

Set the VFO tuning step to 5, 6.25, 10, 12.5, 15, 20, 25, 30 or 50 kHz. (default: Depending on the versions)

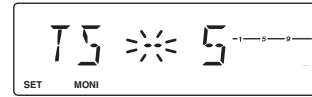

◇ Scan pause timer

Select the scan pause timer option.

When receiving a signal, the scan pauses according to the scan Pause Timer. (default: SCP-10)

- “SCP-2”–“SCP-20” : When receiving a signal, the scan pauses for 2 to 20 seconds (set in 2 seconds steps).
- “SCP-HO” : When a signal is received, the scan pauses until it disappears.

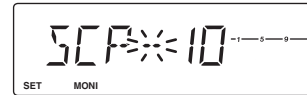

◇ Scan resume timer

Set the scan resume options of a pause after the received signal disappears. (default: SCT-2)

- “SCT-0” : The scan resumes immediately after the signal disappears.
- “SCT-1”–“SCT-5” : The scan resumes 1 to 5 seconds after the signal disappears.
- “SCT-HO” : The scan remains paused according to the Pause Timer, even if the signal disappears. Rotate [DIAL] to resume the scan.

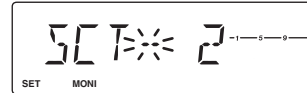

◇ Display dimmer

Set the backlight brightness to between 1 (Dark) and 4 (Bright; default).



◇ Auto dimmer

Set the Auto Dimmer brightness.

The Auto Dimmer function automatically reduces the backlight brightness if no operation has been performed for 5 seconds.

- “ATD OF” (default): Auto Dimmer function is turned OFF. The backlight is continuously ON, while the transceiver is turned ON.
- “AT OF” : The backlight automatically turns OFF if no operation has been performed for 5 seconds.
- “AT D1” – “AT D3” : The backlight lights with the level 1 (Dark) to 3 (Bright), if no operation has been performed for 5 seconds.



11 OTHER FUNCTIONS

◇ Display color

Select the display backlight color from Amber (default), Yellow or Green.

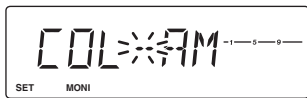

Amber (default)

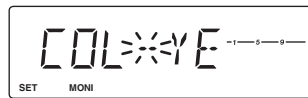

Yellow

◇ LCD contrast

Adjust the LCD contrast.

Adjustable level: 1 (the lowest contrast) to 4 (the highest contrast).

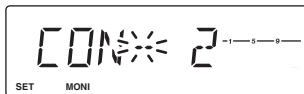

Contrast level "2" (default)

◇ Transmit permission

Select "OFF" to inhibit transmitting on the channel.

This function can be independently set for each memory channel, Call channel and VFO.



Transmit is permitted. (default)



Transmit is inhibited.

◇ Channel skip setting

Turns the Skip function ON (skip) or OFF.

This item appears only when the Set mode is accessed from the memory mode.



Scans the memory channel during memory or bank scan. (default)



Skips the memory channel during a memory or bank scan.

◇ Memory bank setting

Assign the desired memory channels and scan edge channels to the memory bank, for easy memory management. 10 banks, Bank-A to Bank-J, are selectable.

This item appears only when the Set mode is accessed from the memory mode.



Not assigned (default)



Assigned to the bank A

◇ Memory bank link function

The transceiver has 10 banks, A to J. Regular memory channels 0 to 199, and scan edge channels 1A to 3B, can be assigned into the desired bank for easy memory management.

The link function has a continuous banks scan that scans all contents in the selected banks during the scan.

This item appears only when the Set mode is accessed from the memory mode.



Bank link OFF (default)

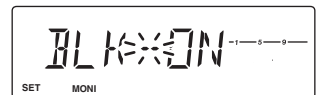

Bank link ON

• Setting the Bank link

① Rotate [DIAL] to turn ON the Memory Bank Link function.

② Push [SET] or [MONI] to select the desired bank to be linked.

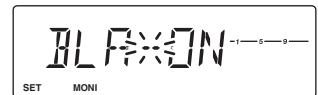

③ Rotate [DIAL] to select "ON" to link the bank.

④ Repeat steps ② and ③, to set the links.

◇ Wide/Narrow setting

Set both the transmission and reception passband width to wide or narrow.

This setting can be independently set for each memory channel, Call channel and VFO.

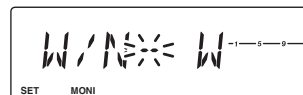

Wide (default)



Narrow

◇ Weather alert function U.S.A. versions only

Turn the Weather Alert function ON or OFF.



Weather alert OFF (default)



Weather alert ON

◇ Microphone sensitivity

Set the microphone sensitivity to High (HI) or Low (LO) to suit your preference.

Higher value makes the microphone more sensitive to your voice.

(default: Depending on the transceiver versions)

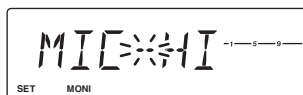

High sensitivity

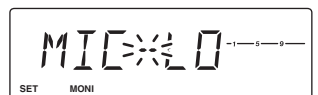

Low sensitivity

■ Initial Set mode

The Initial Set mode is accessed at power ON, and allows you to set seldom-changed settings. In this way, you can “customize” the transceiver to suit your preference and operating style.

◇ Entering the Initial Set mode

- ① While holding down [SET], hold down [⏻] for 1 second to enter the Initial Set mode.
- ② Push [SET] or [MONI] to select the desired item.
- ③ Rotate [DIAL] to set the option or value.
- ④ Push [⏻] to exit the Initial Set mode.

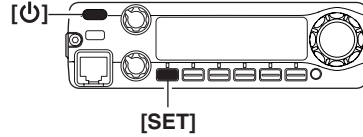

Initial Set mode items

↑: [MONI] ↓: [SET]	• Key-touch beep		Turn the confirmation beeps ON (default) or OFF. p. 48
	• Time-out timer		Inhibit continuous transmissions longer than the set time period. p. 48
	• Auto repeater (For only the USA version.)		Turns the Auto Repeater function ON or OFF. p. 48
	• Auto power OFF		Automatically turns the transceiver's power OFF. p. 48
	• Repeater lockout		Set the transmission lockout capability. p. 48
	• Squelch delay		Set the squelch delay. p. 48
	• Squelch type		Set the squelch type. p. 48
	• Tone burst		Turn the Tone Burst function ON or OFF. p. 49
	• DTMF speed		Set the DTMF sending rate. p. 49
	• Display type		Set the display type for memory mode operation. p. 49
	• Voltage display		Turn the Voltage display function ON or OFF. p. 49

11 OTHER FUNCTIONS

◇ Key-touch beep

Turn the confirmation beeps ON (default) or OFF.

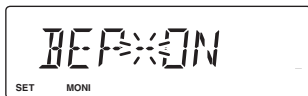

◇ Time-out timer

To prevent accidental prolonged transmission, the transceiver has a time-out timer. The function inhibits continuous transmissions longer than the set time period (1–30 minutes).

- TOT-OFF : Turns OFF the function. (default)
- TOT-1–30 : The transmission is cut OFF after the set time period ends.



◇ Auto repeater

U.S.A. version only

The Auto Repeater function automatically turns the **duplex** setting and tone encoder ON or OFF when the operating frequency falls within or outside of the general **repeater** output frequency range (145.200–145.495 MHz, 146.610–146.995 MHz and 147.000–147.395 MHz).

The offset and repeater tone frequencies are not changed by the Auto Repeater function; reset these frequencies, if necessary.

- OF : The Auto Repeater function is OFF.
- R1 : Activates for duplex only. (default)
- R2 : Activates for duplex and tone.



◇ Auto power OFF

The transceiver can be automatically turned OFF, when no key operation is performed for the specified time period. 30 min., 1 hour, 2 hours and OFF (default) are selectable.

The time period is retained, even if the transceiver is turned OFF by the auto power OFF function. To cancel the function, select "OF" (OFF).



◇ Repeater lockout

Set the transmission lockout (temporary transmission inhibit) capability.

- OF : No lockout is activated. (default)
- RP : The repeater lockout is turned ON.
- BU : The **busy lockout** is turned ON.



Busy lock-out setting

Repeater lock-out setting

◇ Squelch delay

Set the squelch delay to short or long. The delay prevents the squelch from repeatedly opening and closing, while receiving the same signal.

- S : Short squelch delay. (default)
- L : Long squelch delay.



Short squelch delay setting

Long squelch delay setting

◇ Squelch type

Set the squelch type to OFF (Noise squelch), S-meter Squelch or Squelch Attenuator.

- OF : Noise squelch (default)
- SS : S-meter squelch

The S-meter squelch allows you to set a minimum signal level needed to open the squelch. Rotate [SQL] to adjust the S-meter squelch level. The S-meter is automatically activated when [SQL] is rotated further than the 12 o'clock position.

- AT : Squelch Attenuator

The **attenuator** is automatically activated when [SQL] is rotated further than the 12 o'clock position. Approximately 20 dB of attenuation is obtained at the maximum setting.



Noise squelch (default)

S-meter squelch

◇ Tone burst

Turn the Tone Burst function ON or OFF.

- OF : When you transmit a signal that superimposes the CTCSS tone or subaudible tone, the squelch tail noise may be audible on the RX side.
- ON : When you transmit a signal which superimposes the CTCSS tone or subaudible tone, the squelch tail noise is suppressed on the RX side.



Tone burst "OFF" (default)

◇ DTMF speed

Set the rate at which DTMF memories send individual DTMF characters to accommodate your operating needs.

- 1 : 100 milliseconds interval; 5.0 cps speed (default)
- 2 : 200 milliseconds interval; 2.5 cps speed
- 3 : 300 milliseconds interval; 1.6 cps speed
- 5 : 500 milliseconds interval; 1.0 cps speed



◇ Display type

Set the display type for memory mode operation.

- FR : Displays the programmed frequency. (default)
- CH : Displays the memory channel number.*
- NM : Displays the channel name (if programmed)

*Only programmed memory channels can be selected.

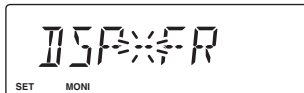

Frequency

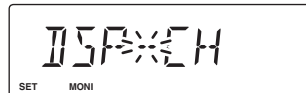

Memory channel number

◇ Voltage display

Turn the Voltage Display function ON or OFF.

- OF : OFF.
- ON : The supplied voltage is displayed, when turning ON the power. (default)



Weather channel operation (Only USA versions)

Weather channel selection

- ① Push **[M/CALL]** one or more times to select the weather channel group.
- ② Rotate **[DIAL]** to select the desired weather channel.
- ③ Push **[M/CALL]** to select the memory mode, or push **[V/MHz]** to select the VFO mode.

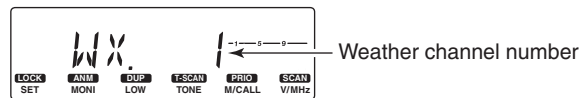

Weather Alert function

NOAA broadcast stations transmit weather alert tones before important weather announcements. When the Weather Alert function is turned ON, the transceiver checks the selected weather channel every 5 seconds for an announcement. When the alert signal is detected, the "AL.T" and the WX channel are displayed alternately and a beep tone sounds until the transceiver is operated. The selected (used) weather channel is checked periodically during standby or while scanning.

- ① Select the desired weather channel.
- ② Push **[SET]** to enter the Set mode.
- ③ Push **[SET]** or **[MONI]** to select the weather alert item, and then rotate **[DIAL]** to select "ON."
- ④ Push any key other than **[SET]** or **[MONI]** to save the selection and exit the Set mode.
- ⑤ Set the desired stand-by mode.
 - Select the VFO, memory channel or Call channel.
 - Scan or **priority watch** operation can be also selected.
- ⑥ When the alert is detected, a beep sounds and the following will be displayed.

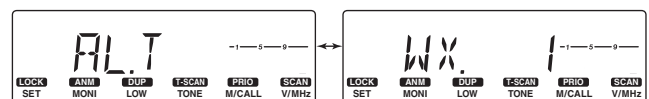

When the weather alert is detected:



Alternately displays above indications.



NOTE: While receiving a signal on a frequency other than the weather channel, the receiving audio will be momentarily interrupted approximately every 5 seconds, when the alert function is turned ON. This is caused by the Weather Alert function. To cancel these interruptions, turn OFF the Weather Alert function in the Set mode.

■ Microphone keys

[F-1]  and [F-2]  on the supplied HM-133V memorize the transceiver settings.



The [UP] and [DOWN] keys on the standard or optional microphone (other than the HM-133V) can be assigned functions like the function keys on the transceiver's front panel.

◇ [F-1] and [F-2] keys on HM-133V



The following functions can be assigned to the microphone's [F-1]  and [F-2]  keys.

- Operating frequency
- Repeater settings
(offset direction and offset, tone ON/OFF and frequency)
- Tone/DTCS squelch
(ON/OFF, frequency/code and polarity)
- Transmit output power setting
- Setting the Set mode items
- Setting the Initial Set mode items (except "Display Type")



➔ Programming the function



Select the desired function, and then hold down [F-1]  or [F-2]  for 1 second.

- 3 beeps sound.

To program the Set and Initial Set modes items, push [FUNC] , and then hold down [F-1]  or [F-2]  for 1 second.

➔ Recalling the function

Push [F-1]  or [F-2] .

To recall the Set and Initial Set modes items, push [FUNC] , and then [F-1]  or [F-2] .

◇ [UP] and [DN] keys on a microphones other than the HM-133V

When turning ON the transceiver's power, the following functions are pre-assigned to [UP] or [DN] on microphones other than HM-133V.

[UP] : Channel up; hold down for 1 second to start the scan, push again to stop it.

[DN] : Channel down; hold down for 1 second to start the scan, push again to stop it.

➔ Assigning a function

- ① Turn OFF the power.
- ② While holding down the desired key on the transceiver and either [UP] or [DN] keys on the microphone, turn ON the power.
 - The function is assigned to the key.

➔ Clearing an assignment

- ① Turn OFF the power.
- ② While holding down the desired [UP] or [DN] key on the microphone, turn ON the power.

■ Partial reset

If you want to reset the VFO frequency, VFO settings and Set mode items to their default values, without clearing the memory contents, you can do a partial reset of the transceiver's **CPU**.

- While holding down [V/MHz], hold down [⏻] for 1 second to turn ON the power.
 - The CPU is partially reset.

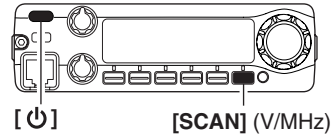

■ All Reset

The function display may, at rare times, display erroneous information (for example when first applying power). This may be externally caused by static electricity or other factors.

In such case, first turn OFF the power, wait a few seconds, then turn ON the power again.

If the problem persists, perform the following procedure.

/// IMPORTANT!:

/// All Rest **CLEAR**s all memory contents and resets all values in the CPU to default. A Partial Reset can also be done that will not clear memory content, but may not solve the problem.

- ① Turn OFF the power, if the transceiver is ON.
- ② While holding down [SET] and [S.MW], hold down [⏻] for 1 second to turn ON the power.
 - The transceiver is totally reset.

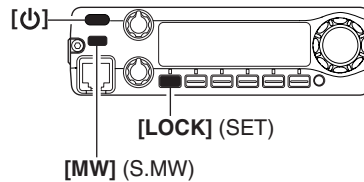

■ Data cloning

Cloning allows you to quickly and easily transfer the programmed contents from one transceiver to another, or data from a personal computer to a transceiver, using the optional CS-2300H CLONING SOFTWARE.

◇ Cloning between two transceivers

- ① Connect the master and sub-transceivers using the OPC-474 cloning cable through the speaker jack.
 - The master transceiver is used to send data to the sub-transceiver.
- ② Enter the cloning mode as following.

For the master transceiver:
While holding down [M/CALL] (PRIO), hold down [⏻] for 1 second to turn ON the power.

For the sub-transceiver:
Hold down [⏻] 1 second to turn ON the power.

 - “CLONE” appears and the transceivers enter the cloning standby mode.
- ③ Push [S.MW] on the master transceiver.
 - “CL OUT” appears on the master transceiver’s display and the S/Rf meter shows that data is being transferred to the sub-transceiver.
 - “CL IN” appears on the sub-transceiver’s display and the S/Rf meter shows that data is being received from the master transceiver.
- ④ When the cloning is finished, turn OFF both transceiver’s power, and then turn ON the power again to exit the cloning mode.

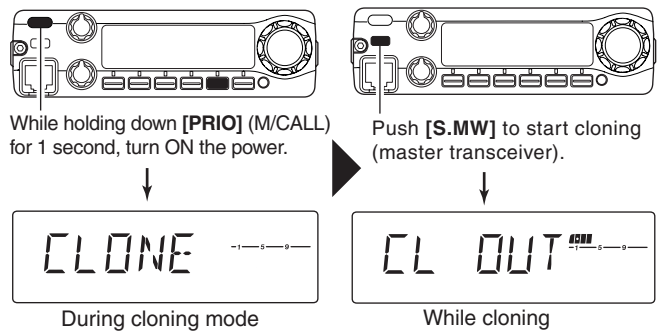
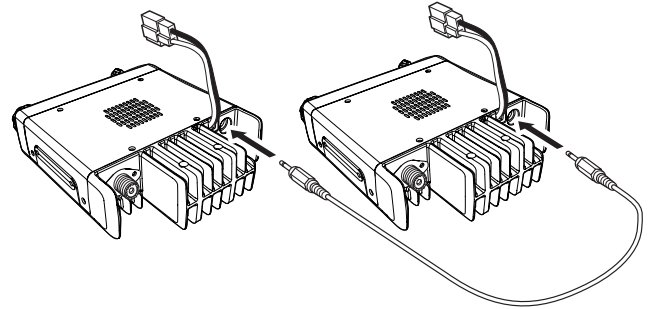

◇ Cloning using a PC

Data can be transferred to and from a PC, using the optional CS-2300H CLONING SOFTWARE and OPC-478 (RS-232C type) or OPC-478UC (USB type) CLONING CABLE. Consult the CS-2300H CLONING SOFTWARE HELP file for details.

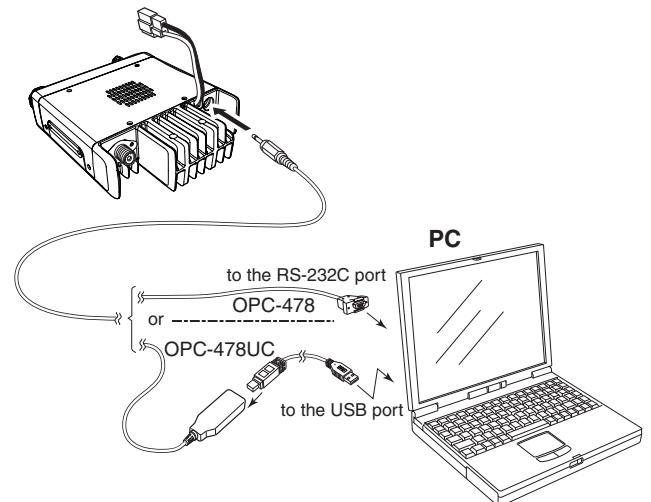

◇ Cloning error

NOTE: DO NOT push any key on the sub-transceiver while cloning. This will cause an error.

When the display to the right appears, a cloning error has occurred.

In this case, both transceivers automatically return to the clone standby mode. Please follow the cloning procedures again.

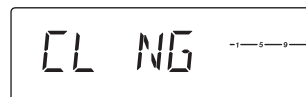



12 SPECIFICATIONS

■ GENERAL

- Frequency coverage : (unit: MHz)
 - USA Tx: 144–148/Rx: 136–174*
 - Export Tx: 136–174*/Rx: 136–174*
 - Taiwan, Korea Tx/Rx: 144–146
- *Guaranteed: 144–148 MHz range only.
- Type of emission : FM
- Number of memory channels : 207 (incl. 6 scan edges and 1 Call)
- Scan types : Full, Program, Priority, Memory channel, Bank, Skip, Tone scans
- Frequency resolution : 5, 6.25, 10, 12.5, 15, 20, 25, 30, 50 kHz
- Operating temperature range : –10°C to +60°C; +14°F to +140°F
- Frequency stability : ±3 ppm (–10°C to +60°C)
- Power supply requirement : 13.8 V DC ±15%
- Current drain (at 13.8 V DC: approximately):
 - Transmit at 65 W 11 A
(less than 9 A at 24 W for the Taiwan version)
 - Receive standby 0.4 A
max. audio 1.5 A
- Antenna connector : SO-239 (50 Ω)
- Dimensions (proj. not included) : 140.0(W)×40.0(H)×118.0(D) mm;
5.5(W)×1.6(H)×4.6(D) in
- Weight (approximately) : 1.1 kg; 2.4 lb

■ TRANSMITTER

- Modulation system : Variable reactance frequency mod.
- Output power (approximately) :

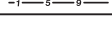
	USA, Export	Taiwan	Korea
High: 	65 W	24 W	50 W
Mid: 	25 W	10 W	25 W
Mid-Low: 	10 W	–	10 W
Low: 	5 W	5 W	5 W

- Max. frequency deviation : ±5.0 kHz (Wide)/±2.5 kHz (Narrow)
- Spurious emissions : Less than –60 dBc
- Microphone connector : 8-pin modular (600 Ω)

■ RECEIVER

- Receive system : Double-conversion superheterodyne
- Intermediate frequencies : 1st: 46.35 MHz, 2nd: 450 kHz
- Sensitivity (at 12 dB SINAD) : Less than 0.18 μV
- Squelch sensitivity : Less than 0.13 μV (threshold)
- Selectivity :
 - [Wide] More than ±6 kHz/6 dB
Less than ±14 kHz/60 dB
 - [Narrow] More than ±3 kHz/6 dB
Less than ±9 kHz/55 dB
- Spurious and image rejection : More than 60 dB
- AF output power (at 13.8 V DC) : More than 3.5 W (4.5 W typical)
(at 10% distortion with a 4 Ω load)
- External speaker connector : 3-conductor 3.5 (d) mm (1/8 inch)/4 Ω

All stated specifications are subject to change without notice or obligation.

■ Troubleshooting

If your transceiver seems to be malfunctioning, please check the followings before sending it to the service center.

PROBLEM	POSSIBLE CAUSE	SOLUTION	REF.
No power comes on.	<ul style="list-style-type: none"> • Power connector has a poor contact. • Polarity of the power connection is reversed. • Blown fuse. 	<ul style="list-style-type: none"> • Check the connector pins. • Re-connect the power cable observing the proper polarity. Replace the fuse if blown. • Check the cause, repair it, then replace the fuse following the instruction below. 	p. iv – –
No sound comes from the speaker.	<ul style="list-style-type: none"> • Volume is too low. • The audio mute function is activated. • Squelch is set too tight. • A selective call or Squelch function is activated such as pocket beep or tone squelch. 	<ul style="list-style-type: none"> • Rotate [VOL] clockwise. • Push any switch or key to deactivate it. • Set the squelch level to the threshold. • Turn OFF the those functions. 	p. 8 p. 9 p. 8 pp. 39, 41
Sensitivity is low and only strong signals are audible.	<ul style="list-style-type: none"> • Antenna feedline or the antenna connector solder has a poor contact or is shorted. • The S-meter Squelch or Squelch Attenuator function is activated. 	<ul style="list-style-type: none"> • Check, and if necessary, replace the feedline or re-solder the antenna connector. • Set [SQL] to between the 10 and 12 o'clock position. • Turn OFF the S-meter squelch or squelch attenuator. 	p. v p. 8 p. 9
No direct contact possible with other stations.	<ul style="list-style-type: none"> • The other station is using tone squelch. • The transceiver is set to duplex. 	<ul style="list-style-type: none"> • Set the appropriate tone frequency or code, and then turn ON the tone or DTCS squelch. • Select the simplex mode. 	p. 41 p. 12
Repeater cannot be accessed.	<ul style="list-style-type: none"> • Wrong frequency offset is programmed. • Wrong subaudible tone frequency is programmed. 	<ul style="list-style-type: none"> • Correct the frequency offset. • Correct the subaudible tone frequency. 	p. 15 p. 13
Frequency cannot be set.	<ul style="list-style-type: none"> • The frequency lock function is activated. • Priority watch is paused on the watching frequency. 	<ul style="list-style-type: none"> • Turn the function OFF. • Cancel the watch. 	p. 7 p. 35
Frequency cannot be set using the microphone.	<ul style="list-style-type: none"> • The frequency lock function is activated. • Priority watch is paused on the watching frequency. 	<ul style="list-style-type: none"> • Turn the function OFF. • Cancel the watch. 	p. 7 p. 35
Some memory channels cannot be selected using the microphone keypad.	<ul style="list-style-type: none"> • The input channel number has not yet been programmed. 	<ul style="list-style-type: none"> • Rotate [DIAL] to check whether the channel has been programmed or not. 	–
Scan does not start.	<ul style="list-style-type: none"> • The squelch is open. • Only one memory channel is programmed or other channels are set as skip channels. • Priority watch is activated. 	<ul style="list-style-type: none"> • Set the squelch to the threshold point. • Program other memory channels or cancel the memory skip function in the desired channels. • Cancel the watch. 	p. 8 pp. 17, 32 p. 35
Transmission is automatically cut off.	<ul style="list-style-type: none"> • Time-out timer is activated. 	<ul style="list-style-type: none"> • Turn OFF the timer. 	p. 48
Transmission continues even when the PTT is released.	<ul style="list-style-type: none"> • One-touch PTT function is activated. 	<ul style="list-style-type: none"> • Turn OFF the function. 	p. 11
The function display shows erroneous information.	<ul style="list-style-type: none"> • The CPU is malfunctioning. 	<ul style="list-style-type: none"> • Reset the CPU. 	p. 52

■ Fuse replacement

If the fuse is blown or the transceiver stops functioning, find the source of the problem if possible, repair the problem and then replace the damaged fuse with a new rated one (FGB 20 A), as shown at right.

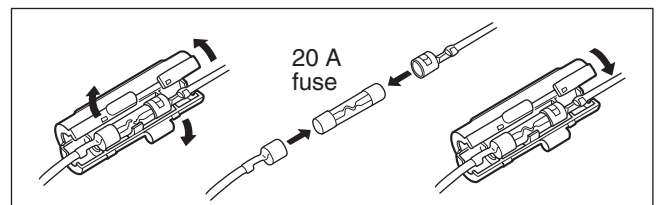

Count on us!

