

YAESU
The radio

FT-818ND

Operating Manual

HF/VHF/UHF
SSB/CW/AM/FM ULTRA-COMPACT TRANSCEIVER



Contents

| | | | |
|---|-----------|--|-----------|
| Introduction | 1 | ARTS™ (Auto Range Transpond System) Operation..... | 33 |
| Safety Precautions | 2 | CW Identifier Setup | 33 |
| Accessories & Options | 4 | Digital Mode Operation (SSB-Based AFSK).... | 34 |
| Supplied Accessories..... | 4 | RTTY (Radio TeleType) Operation | 34 |
| Available Options | 4 | PSK31 Operation | 35 |
| Installation | 5 | “USER” Defined Digital Modes | 36 |
| Connecting the Supplied YHA-63 Antenna.... | 5 | Packet (1200/9600 bps FM) Operation..... | 37 |
| Connecting the Microphone | 6 | AM Transmission | 38 |
| Shoulder Strap Installation..... | 6 | Split Frequency Operation | 38 |
| Rubber Foot Installation..... | 6 | Time-Out Timer | 39 |
| Alkaline Battery Installation and Use | 7 | Weather Fax Monitoring..... | 39 |
| External Power Connections..... | 8 | Memory Operation | 40 |
| SBR-32MH Ni-MH Battery Pack Installation and Use | 9 | QMB Channel | 40 |
| Installation | 9 | QMB Channel Storage | 40 |
| Charging..... | 9 | QMB Channel Recall..... | 40 |
| Front Panel Control & Switches | 10 | Memory Operation on “Regular” Memory Channels..... | 41 |
| Display Icons | 13 | Normal Memory Storage | 41 |
| Side Panel Switch & Connectors | 14 | Split-Frequency Memory Storage..... | 41 |
| Rear Panel Connectors | 15 | Memory Channel Recall | 42 |
| Operation | 16 | Masking Memory | 42 |
| Turning the Transceiver On and Off..... | 16 | Memory Operation on “HOME” Channel Memories | 43 |
| Supply Voltage Display | 16 | HOME Channel Storage..... | 43 |
| Operating Band Selection..... | 17 | HOME Channel Recall | 43 |
| Mode Selection | 17 | Labeling Memories..... | 44 |
| Adjusting the Audio Volume Level..... | 17 | Setting the Spectrum Scope Mode..... | 45 |
| Menu Quick Start | 18 | Activate the Spectrum Scope | 45 |
| Adjusting the RF Gain and Squelch..... | 18 | Spectrum Scope Monitor Operation | 45 |
| Setting the Operating Frequency | 19 | Smart Search™ Operation | 46 |
| Stacked VFO System..... | 19 | Scanning Operation | 47 |
| Operation on 5 MHz Band (U.S. Version Only) ... | 20 | Scanning Operation | 47 |
| Receiver Accessories | 21 | Scan Skip Programming (Memory Mode Only).... | 48 |
| Clarifier (Receiver Incremental Tuning) | 21 | Programmable Memory Scan (PMS) Operation... 49 | |
| IF SHIFT | 22 | Dual Watch Operation | 50 |
| AGC (Automatic Gain Control)..... | 22 | Operation on Alaska Emergency Frequency: 5167.5 khz (U.S. Version Only) ... | 51 |
| Noise Blanker..... | 23 | Menu Operation | 52 |
| IPO (Intercept Point Optimization) | 23 | Cloning | 63 |
| ATT (Front End Attenuator)..... | 23 | CAT System Programming | 64 |
| AM/FM DIAL..... | 24 | CAT Data Protocol | 65 |
| Automatic Power-Off Feature | 24 | Constructing and Sending CAT Commands... 65 | |
| Transmitter Operation | 25 | Opcode Command Chart | 66 |
| SSB Transmission..... | 25 | Installation of Optional Accessories | 68 |
| Basic Setup/Operation | 25 | Optional Filters YF-122S/YF-122C/YF-122CN ... 68 | |
| VOX Operation | 26 | Power-on Microprocessor Reset Procedure ... | 69 |
| CW Transmission..... | 27 | Appendix | 69 |
| Operation using Straight Key/ External Keying Device | 27 | BAND DATA FORMAT | 69 |
| Operation using Built-in Electronic Keyer... 29 | | Specifications | 70 |
| FM Transmission..... | 30 | | |
| Basic Setup/Operation | 30 | | |
| Repeater Operation..... | 30 | | |
| DCS Operation | 32 | | |

The **FT-818** is a compact, innovative multiband, multimode portable transceiver for the amateur radio MF/HF/VHF/UHF bands. Providing coverage of the 160-10 meter bands plus the 6 m, 2 m, and 70 cm bands, the **FT-818** includes operation on the SSB, CW, AM, FM, and Digital modes, yielding the most comprehensive performance package available for portable operation.

Designed for use either from an external DC power source or internal batteries, the **FT-818** provides 6 watts of power output from a 13.8-Volt external power supply. When using the **SBR-32MH** Ni-MH Battery Pack or 8 “AA” Alkaline Cells (not supplied), the **FT-818** automatically switches to 2.5 Watts of output power.

The multi-function Liquid-Crystal Display includes Blue, Amber, and Violet backlighting, which may be disabled for battery conservation. The display includes bar-graph indication of power output, ALC voltage, SWR, and modulation level. Also include are a number of operating status icons, as well as the function displays for the three operating function keys (**A**), (**B**), and (**C**).

Among the advanced features of the **FT-818** are many incorporated only in large base-station transceivers. These include Dual VFOs; Split-Frequency operation; IF Shift; Clarifier (“R.I.T.”); IF Noise Blanker; AGC Fast/Slow/Auto/Off selection; RF Gain and Squelch control; IPO (Intercept Point Optimization) and a receiver front-end Attenuator; AM Aircraft reception; AM and FM Broadcast reception; VOX; Built-in Electronic Keyer; Adjustable CW Pitch; Automatic FM Repeater Shift (ARS); Built-in CTCSS Encoder/Decoders; ARTS™ (Auto-Range Transponder System); Smart Search™ Automatic Memory Loading System; Spectrum Scope; 200 Memories plus Home Channels and Band-limiting Memories; Alpha-Numeric Labeling of Memories; Automatic Power-Off (APO) and Time-Out Timer (TOT) functions; Computer Interface capability; and Cloning capability.

We urge you to read this manual in its entirety, so as to gain a full understanding of the amazing capability of the exciting **FT-818** Portable Transceiver.

Safety Precautions

Note beforehand that the company shall not be liable for any damages suffered by the customer or third parties in using this product, or for any failures and faults that occur during the use or misuse of this product, unless otherwise provided for under the law.



Type and meaning of the marks



 **DANGER** This mark indicates an imminently hazardous situation, which, if not avoided, could result in death or serious injury.

 **WARNING** This mark indicates a potentially hazardous situation, which, if not avoided, could result in death or serious injury.

 **CAUTION** This mark indicates a potentially hazardous situation, which, if not avoided, may result in minor or moderate injury or only property damage.

Type and meaning of symbols

 Prohibited actions that must not be attempted, in order to use this radio safely. For example,  signifies that disassembly is prohibited.

 Precautions that must be adhered to in order to use this radio safely. For example,  signifies that the power supply is to be disconnected.

DANGER

 **Do not use the device in "regions or aircrafts and vehicles where its use is prohibited" such as in hospitals and airplanes.**
This may exert an impact on electronic and medical devices.

 **Do not use this product while driving or riding a motorbike. This may result in accidents.**
Make sure to stop the car in a safe location first before use if the device is going to be used by the driver.

 **Do not operate the device when flammable gas is generated.**
Doing so may result in fire and explosion.

 **Never touch the antenna during transmission.**
This may result in injury, electric shock and equipment failure.

 **Do not transmit in crowded places in consideration of people who are fitted with medical devices such as heart pacemakers.**
Electromagnetic waves from the device may affect the medical device, resulting in accidents caused by malfunctions.

 **When an alarm goes off with the external antenna connected, cut off the power supply to this radio immediately and disconnect the external antenna from this radio.**
If not, this may result in fire, electric shock and equipment failure.

 **Do not touch any liquid leaking from the liquid display with your bare hands.**
There is a risk of chemical burns occurring when the liquid comes into contact with the skin or gets into the eyes. In this case, seek medical treatment immediately.

WARNING

 **Do not use voltages other than the specified power supply voltage.**
Doing so may result in fire and electric shock.

 **Do not transmit continuously for long periods of time.**
This may cause the temperature of the main body to rise and result in burns and failures due to overheating.

 **Do not dismantle or modify the device.**
This may result in injury, electric shock and equipment failure.

 **Do not handle the power plug and connector etc. with wet hands. Also do not plug and unplug the power plug with wet hands.**
This may result in injury, liquid leak, electric shock and equipment failure.

 **Keep the power plug pins and the surrounding areas clean at all times.**
This may result in fire, liquid leak, overheating, breakage, ignition etc.

 **When smoke or strange odors are emitted from the radio, turn off the power and disconnect the power cord from the socket.**
This may result in fire, liquid leak, overheating, damage, ignition and equipment failure. Please contact our company amateur customer support or the retail store where you purchased the device.











 **Disconnect the power cord and connection cables before incorporating items sold separately and replacing the fuse.**
This may result in fire, electric shock and equipment failure.

 **Never cut off the fuse holder of the DC power cord.**
This may cause short-circuiting and result in ignition and fire.



















 **Do not use fuses other than those specified.**
Doing so may result in fire and equipment failure.

 **Do not allow metallic objects such as wires and water to get inside the product.**
This may result in fire, electric shock and equipment failure.

Safety Precautions

-  **Do not place the device in areas that may get wet easily (e.g. near a humidifier).**
This may result in fire, electric shock and equipment failure.
-  **When connecting a DC power cord, pay due care not to mix up the positive and negative polarities.**
This may result in fire, electric shock and equipment failure.
-  **Do not use DC power cords other than the one enclosed or specified.**
This may result in fire, electric shock and equipment failure.
-  **Do not bend, twist, pull, heat and modify the power cord and connection cables in an unreasonable manner.**
This may cut or damage the cables and result in fire, electric shock and equipment failure.
-  **Refrain from using headphones and earphones at a loud volume.**
Continuous exposure to loud volumes may result in hearing impairment.
-  **Do not pull the cable when plugging and unplugging the power cord and connection cables.**
Please hold the plug or connector when unplugging. If not, this may result in fire, electric shock and equipment failure.
-  **Do not use the device when the power cord and connection cables are damaged, and when the DC power connector cannot be plugged in tightly.**
Please contact our company amateur customer support or the retail store where you purchased the device as this may result in fire, electric shock and equipment failure.
-  **Follow the instructions given when installing items sold separately and replacing the fuse.**
This may result in fire, electric shock and equipment failure.
-  **Do not use the device when the alarm goes off.**
For safety reasons, please pull the power plug of the DC power equipment connected to the product out of the AC socket.
-  **Never touch the antenna as well. This may result in fire, electric shock and equipment failure due to thunder.**

CAUTION

-  **Do not place this device near a heating instrument or in a location exposed to direct sunlight.**
This may result in deformation and discoloration.
-  **Do not place this device in a location where there is a lot of dust and humidity.**
Doing so may result in fire and equipment failure.
-  **Stay as far away from the antenna as possible during transmission.**
Long-term exposure to electromagnetic radiation may have a negative effect on the human body.
-  **Do not wipe the case using thinner and benzene etc.**
Please use a soft and dry piece of cloth to wipe away the stains on the case.
-  **Keep out of the reach of small children.**
If not, this may result in injuries to children.
-  **Do not put heavy objects on top of the power cord and connection cables.**
This may damage the power cord and connection cables, resulting in fire and electric shock.
-  **Do not transmit near the television and radio.**
This may result in electromagnetic interference.
-  **Do not use optional products other than those specified by our company.**
If not, this may result in equipment failure.
-  **When using the device in a hybrid car or fuel-saving car, make sure to check with the car manufacturer before using.**
The device may not be able to receive transmissions normally due to the influence of noises from the electrical devices (inverters etc.) fitted in the car.
-  **Do not turn on the volume too high when using a headphone or earphone.**
This may result in hearing impairment.
-  **For safety reasons, switch off the power and pull out the DC power cord connected to the DC power connector when the device is not going to be used for a long period of time.**
If not, this may result in fire and overheating.
-  **Do not throw or subject the device to strong impact forces.**
This may result in equipment failure.
-  **Do not put this device near magnetic cards and video tapes.**
The data in the cash card and video tape etc. may be erased.
-  **Do not place the device on an unsteady or sloping surface, or in a location where there is a lot of vibration.**
The device may fall over or drop, resulting in fire, injury and equipment failure.
-  **Do not stand on top of the product, and do not place heavy objects on top or insert objects inside it.**
If not, this may result in equipment failure.
-  **Do not use a microphone other than those specified when connecting a microphone to the device.**
If not, this may result in equipment failure.
-  **Do not touch the heat radiating parts.**
When used for a long period of time, the temperature of the heat radiating parts will get higher, resulting in burns when touched.
-  **Do not open the case of the product except when replacing the fuse and when installing items sold separately.**
This may result in injury, electric shock and equipment failure.

Accessories & Options

Supplied Accessories

| | |
|---------------------|--|
| MH-31A8J | Hand Microphone |
| SBR-32MH | Ni-MH Battery Pack (9.6 V, 1900 mAh) |
| PA-48B/C/U * | Battery Charger |
| FBA-28 | Battery Case (holds 8 "AA" size Alkaline cells [not supplied]) |
| YHA-63 | Whip Antenna for (50/144/430 MHz) |
| E-DC-6 | DC Cable |
| Shoulder Strap | |
| Ferrite Core | |
| Rubber Foot | |

Available Options

| | |
|---------------------|--|
| SBR-32MH | Ni-MH Battery Pack (9.6 V, 1900 mAh) |
| PA-48B/C/U * | Battery Charger |
| YF-122S | Collins SSB Filter (2.3 kHz/4.7 kHz: -6 dB/-66 dB) |
| YF-122C | Collins CW Filter (500 Hz/2 kHz: -6 dB/-60 dB) |
| YF-122CN | Collins CW Filter (300 Hz/1 kHz: -6 dB/-60 dB) |
| MH-31A8J | Hand Microphone |
| MH-36E8J | DTMF Microphone |
| M-1 | Reference Microphone |
| M-100 | Dual Element Microphone |
| YH-77STA | Lightweight Stereo Headphone |
| SCU-17 | USB Interface Unit |
| CSC-83 | Soft Case |
| CT-62 | CAT Interface Cable |
| CT-39A | Packet Cable |
| ATAS-25 | Active Tuning Antenna (Manual Type) |

*: Depends on the transceiver version.

Connecting the Supplied YHA-63 Antenna

Your **FT-818** is supplied with a three-section antenna, model **YHA-63** which is designed for optimum performance on the 50 MHz, 144 MHz, and 430 MHz. It also works well on the FM broadcast and other VHF bands. This antenna is intended for connection to the front panel's BNC-type antenna connector.

For HF and/or 50 MHz operation, most hikers carry their own dipole or collapsible vertical antenna, fed by a small-diameter coaxial cable terminated in a type "M" (PL-259) plug, and these kinds of antennas may be connected to the rear panel's antenna connector.

The **YHA-63** should be connected to the top panel's "BNC" connector, using the following guidelines:

- For 144/430 MHz operation (only), connect the shorter cap section to the screw post on the top of the main antenna shaft, then screw the assembled **YHA-63** onto the BNC connector, twisting it 1/4 turn clockwise to secure the antenna.
- For 50 MHz operation, unscrew the short cap section, and replace it with the long cap section. The long cap section will provide good results on 144/430 MHz, as well, but those owners not using 50 MHz may prefer the shorter total length of the **YHA-63** when using the short cap on 144/430 MHz.
- For shortwave listening using a random-length wire antenna for reception only, you may wish to consider connection of the wire between the main **YHA-63** shaft and the cap, using a "spade lug" or similar lug on the end of the wire to provide a secure connection between the cap and the rest of the antenna.
- Menu #07 ("ANTENNA") allows you to define which connector ("Front" or "Rear") is used on a particular band. See page 54 for details.

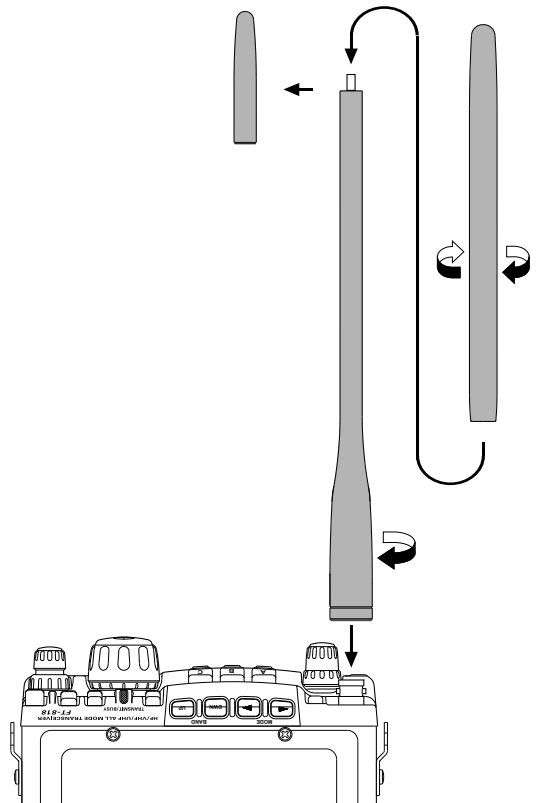

Installation

Connecting the Microphone

- To connect the microphone, plug its connector (latch side UP) into the **MIC** jack on the right side of the transceiver. Press it gently inward until you hear the “click” of the latch.
- To disconnect the microphone, press gently on the “**PUSH ▼**” label on top of the microphone connector’s rubber boot. While pressing on this spot, gently pull the connector outward from the body of the transceiver.

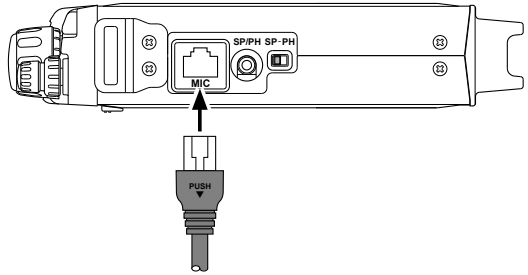

Note: During “Digital” or “Packet” operation, it is not necessary to disconnect the microphone, as activation of the PTT line from the **DATA** connector automatically cuts off the audio input from the **MIC** jack.

Shoulder Strap Installation

The convenient Shoulder Strap is designed for maximum comfort and security for your **FT-818** transceiver.

- Refer to the illustration, and connect the shoulder strap to the attachment tabs just behind the front panel of the **FT-818**. Be sure to have the shoulder strap aligned correctly, without twists in the straps.
- A convenient microphone hanger is located on one end of the padded top section of the Shoulder Strap. When not in use, the microphone may be affixed here, freeing both of your hands for other tasks.



Rubber Foot Installation

Four Rubber Feet are provided with your **FT-818**, for ease of use when operating from a base station or camp table.

Refer to the illustration, and affix the Rubber Feet in the appropriate locations.

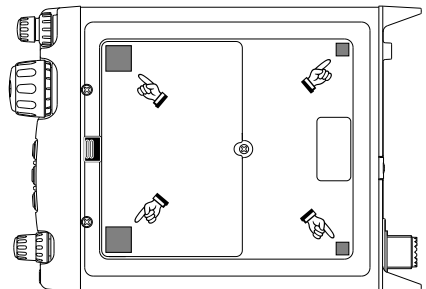

Alkaline Battery Installation and Use

The **FT-818** is supplied with the **FBA-28** holder for Alkaline “AA” cells. A fresh set of Alkaline cells should provide approximately 5.5 hours of reception under typical conditions.

1. To install or replace the AA cells, first remove the battery cover from the bottom side of the transceiver. Slide the battery cover latch forward, as shown in the illustration, then fold the battery cover upward and set it aside temporarily.
2. Install the Alkaline AA cells as shown in the illustration, paying particular attention to the correct polarity of the batteries.
3. When all batteries have been successfully installed, replace the battery cover.

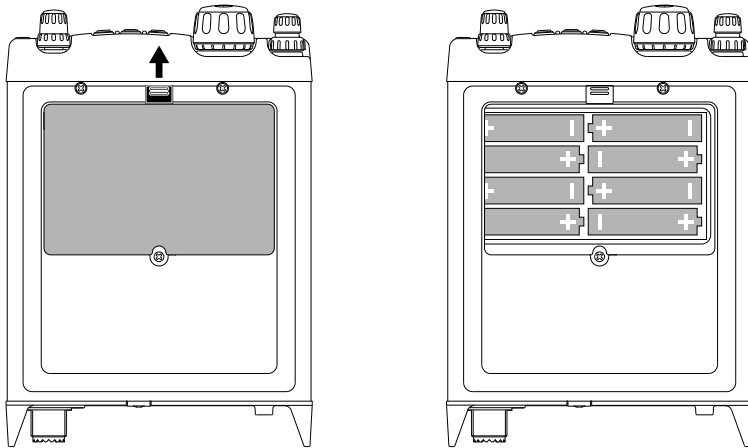

Important Notes

- When the transceiver is to be stored for a long period of time without use (longer than ten days), remove the batteries from the **FBA-28** holder, to avoid the possibility of battery leaking causing damage to the transceiver. Inspect the **FBA-28** battery holder occasionally for signs of corrosion or battery leakage, and remove the batteries immediately if any such damage is observed.
- The **FBA-28** battery holder is designed for use solely with Alkaline type “AA” cells. Do not attempt to use Ni-MH or other rechargeable cells in the **FBA-28**, because it does not contain the protection circuitry required when using rechargeable cells.
- When replacing batteries, replace all eight AA cells simultaneously with fresh batteries.
- When the battery voltage is approaching the value which indicates depletion is near, the small “” will blink, indicating it is time to replace the batteries.

Installation

External Power Connections

The **FT-818** may be connected to an external 13.8 Volt DC power source providing at least 3 Amps of continuous-duty current.. The supplied **E-DC-6** DC cable may be used for DC connections.

While connected to an external DC source, if you have installed the supplied **SBR-32MH** Ni-MH Battery Pack, the **E-DC-6** connection to the external DC power source will allow operation of the **FT-818** while charging of the **SBR-32MH** is in progress.

When making DC power connections, be absolutely certain to follow the markings on the **E-DC-6** so as to ensure proper polarity of the connection to the power supply. Connect the RED AND BLACK OR WHITE AND BLACK wire to the Positive (+) power supply terminal, and connect the SOLID BLACK wire to the Negative (-) power supply terminal.

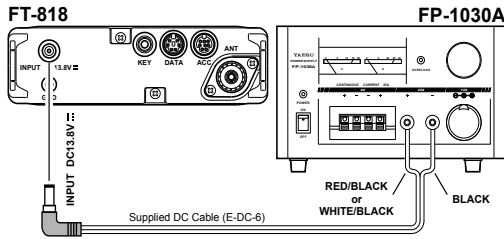

Notice

Be extremely careful when making power supply connections. Use only a 13.8 Volt DC Supply, and carefully observe the proper electrical polarity. Serious damage may result if these precautions are not observed.

The Limited Warranty on this product does not cover damage caused by improper power supply connections, or improper power supply voltage.

Important Note

Occasionally, the 430 MHz transmit signal may behave abnormally when the **FT-818** is operated using an External Power Supply and the whip antenna, especially with the antenna in close proximity to surrounding metal objects.

If abnormal transmitter operation is experienced, wind one turn of the **E-DC-6** DC cable around the supplied ferrite core, and snap its two halves together, per the illustration below. Install the core as close as possible to the DC plug, as shown.

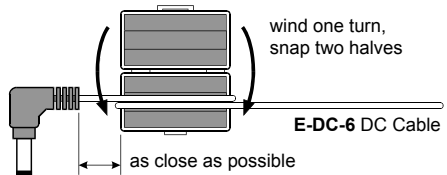

SBR-32MH Ni-MH Battery Pack Installation and Use

The supplied **SBR-32MH** Ni-MH Battery Pack provides 9.6 Volts of DC power for your **FT-818**, with a maximum capacity of 1900 mAh.

Installation

1. To install the **SBR-32MH** Ni-MH Battery Pack, first remove the battery compartment cover, as described previously.
2. Lift out the **FBA-28** battery holder, and disconnect the short cable connected to the **FBA-28**, as shown in the illustration.
3. Connect the short cable to the mating connector on the **SBR-32MH**, and install the **SBR-32MH** in the battery compartment.
4. Replace the battery compartment cover.

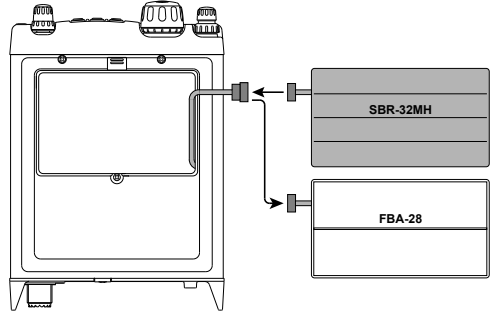

Charging

Charging of the **SBR-32MH** requires the use of either the supplied battery charger (**PA-48B/C/U**), or an external 13.8 Volt ($\pm 15\%$) DC source. If the battery charger is used, the **FT-818** must be turned off during charging; if an external 13.8 Volt DC source is used (connected via the supplied **E-DC-6** cable), then you may operate the **FT-818** while charging is in progress.

1. Turn the **FT-818** off, then connect the supplied battery charger DC connector to the **INPUT: 13.8V**  jack on the rear panel of the **FT-818**.
2. Plug the battery charger into the nearest AC wall outlet.
3. Press the **FT-818**'s **PWR** switch for one second to turn the transceiver on.
4. Press the **F** key momentarily.
5. Rotate the **SEL** knob so that the function row containing “[CHG, VLT, DSP]” appears on the display.
6. Press the **A** key to select the [CHG] option (the display will immediately revert to the regular frequency display).
7. Turn the **FT-818** off. The display will indicate “CHG TIME RMN” and remaining time to indicate the time remaining before a full charge is achieved on the **SBR-32MH**.



CHG TIME RMN
7:59

Important Note

- The **PA-48** are not designed to power the transceiver for operation (reception or transmission).
- Please be advised that the **PA-48** may contribute noise to TV and radio reception in the immediate vicinity, so we do not recommend its use adjacent to such devices.

Front Panel Control & Switches

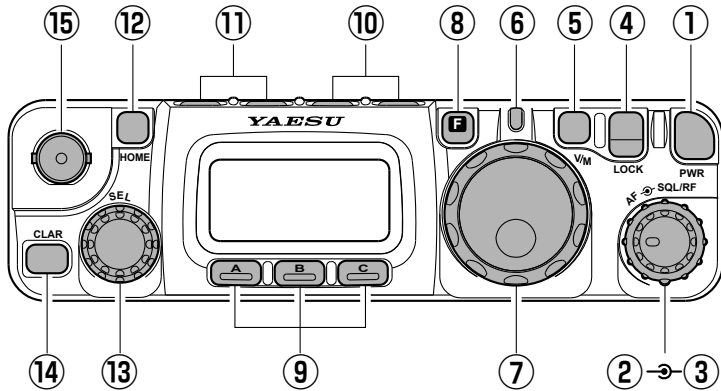

① PWR Switch

Press and hold in the **PWR** switch for one second to turn to the transceiver on or off.

② AF Knob

The (inner) **AF** knob adjusts the receiver audio volume level presented to the internal or external speaker. Clockwise rotation increases the volume level.

③ SQL/RF Knob

In the USA version, this (outer) **SQL/RF** knob adjusts the gain of the receiver's RF and IF stages. Using Menu Selection 45, this control may be changed to function as a Squelch control, which may be used to silence background noise when no signal is present. In the other versions, its default setting is set to "Squelch".

④ LOCK Key

Pressing this key locks the front panel keys so as to prevent accidental frequency change.

⑤ V/M Key

Pressing this key switches frequency control between the VFO and Memory Systems.

⑥ TRANSMIT/BUSY Indicator

This LED glows green when the squelch opens, and turns red during transmit.

⑦ MAIN Dial

This is the main tuning dial for the transceiver. It is used both for frequency tuning as well as "Menu" setting in the transceiver.

⑧ F Key

Pressing this key momentarily changes the display to show the operating functions available via the **A**, **B**, **C** keys.

Press and hold this key for one second to activate the "Menu" mode.

Front Panel Control & Switches

⑨ FUNC Keys

These three keys select many of the most important operating features of the transceiver. When pressing the **F** key, the current function of that key appears above each of the **A**, **B**, **C** keys (along the bottom of the LCD); rotating the **SEL** knob scrolls the display through eleven rows of functions available for use via the **A**, **B**, **C** keys.

The available features are shown in chart on the next page.

⑩ BAND(DWN)/BAND(UP) Key

Pressing either of these keys momentarily will cause the frequency to be moved up or down by one frequency band. The selections available are:

1.8 MHz ↔ 3.5 MHz ↔ 5.0 MHz ↔ 7.0 MHz ↔ 10 MHz ↔ 14 MHz ↔ 15 MHz ↔ 18 MHz
↓ ↑
430 MHz ↔ 144 MHz ↔ 108 MHz ↔ 88 MHz ↔ 50 MHz ↔ 28 MHz ↔ 24 MHz ↔ 21 MHz

⑪ MODE(◀)/MODE(▶) Key

Pressing either of these keys momentarily will change the operating mode. The selections available are:

→ LSB ↔ USB ↔ CW ↔ CWR ↔ AM ↔ FM ↔ DIG ↔ PKT ←

⑫ HOME Key

Pressing this key momentarily recalls a favorite “HOME” frequency memory.

⑬ SEL Knob

This detented rotary switch is used for tuning, memory selection, and function selection for the **A**, **B**, **C** keys of the transceiver.

⑭ CLAR Key

Press this key momentarily to activate the Receiver Clarifier feature. When this feature is activated, the **SEL** knob may be used to set a tuning offset of up to ±9.99 kHz. The transmitter’s frequency is not affected by the setting of the Clarifier.

Press and hold this key for 1/2 second to activate the IF Shift feature, which allows you to use the **SEL** knob to adjust the center frequency of the IF filter’s passband response.

⑮ ANT Jack

Connect the supplied 50/144/430 MHz rubber flex antenna (or another antenna presenting a 50Ω impedance) to this BNC connector.

In its default setting, this jack does not function on the HF bands. If you want to enable this jack on the HF bands, recall and change the setting of Menu #07.

Front Panel Control & Switches

| | A key | B key | C key |
|----------|---|--|---|
| 1 | <p>A/B</p> <p>Press the A key to switch between VFO-A and VFO-B on the display.</p> | <p>A=B</p> <p>Press and hold in the B key for 1/2 second to copy the contents of VFO-A into the VFO-B register, so that the two VFOs' contents will be identical.</p> | <p>SPL</p> <p>Press the C key to activate Split frequency operation between VFO-A and VFO-B.</p> |
| 2 | <p>MW</p> <p>Press and hold in the A key for 1/2 second to transfer the contents of the VFO into a Memory register.</p> | <p>MC</p> <p>Press the B key to designate the current Memory channel to be "skipped" during scanning.</p> | <p>TAG</p> <p>Press the C key to select the display type (Frequency or Alpha-numeric Tag) during Memory operation.</p> |
| 3 | <p>STO</p> <p>Press the A key to store the contents of the VFO into the QMB (Quick Memory Bank) register.</p> | <p>RCL</p> <p>Press the B key to recall the QMB Memory.</p> | <p>PMS</p> <p>Press the C key to activate the Programmable Memory Scan feature.</p> |
| 4 | <p>RPT</p> <p>Press the A key to select the direction of the uplink frequency shift ("-", "+," or Simplex) during FM repeater operation. Press and hold in the A key for 1/2 second to recall Menu #42 (for setting the shift frequency offset).</p> | <p>REV</p> <p>Press the B key to reverse the transmit and receive frequencies while working through a repeater.</p> | <p>TON</p> <p>Press the C key to activate CTCSS or DCS operation. Press and hold in the C key for 1/2 second to recall Menu #48 (for selecting the CTCSS tone frequency).</p> |
| 5 | <p>SCN</p> <p>Press the A key to initiate scanning (in the direction of <i>higher</i> frequencies).</p> | <p>PRI</p> <p>Press the B key to activate the Priority Scan feature.</p> | <p>DW</p> <p>Press the C key to activate the Dual Watch system.</p> |
| 6 | <p>SSM</p> <p>Press the A key to activate the Spectrum Scope Monitor feature. Press and hold in the A key for 1/2 second to recall Menu #43 (for selecting the SSM sweep mode).</p> | <p>SCH</p> <p>Press the B key to activate Smart Search™ operation.</p> | <p>ART</p> <p>Press the C key to initiate the Auto-Range Transponder mode. Press and hold in the C key for 1/2 second to recall Menu #09 (for selecting the ARTS "Beep" option).</p> |
| 7 | <p>IPO</p> <p>Press the A key to bypass the receiver preamplifier, thereby activating Intercept Point Optimization for improved overload characteristics. The IPO feature does not function on 144/430 MHz.</p> | <p>ATT</p> <p>Press the B key to engage the receiver front-end attenuator, which will reduce all signals and noise by approximately 10 dB. The ATT feature does not function on 144/430 MHz.</p> | <p>NAR</p> <p>Press the C key to activate the "Narrow" filter mode in the CW (optional YF-122C or YF-122CN required) mode. On the FM mode, it also selects the low-deviation mode required for HF FM operation on 29 MHz. Press and hold in the C key for 1/2 second to recall Menu #38 (to Enable/Disable the optional filter during installation).</p> |

Front Panel Control & Switches

| | A key | B key | C key |
|-----------|--|--|--|
| 8 | NB Press the A key to activate the receiver's IF Noise Blanker. | AGC Press the B key to select the recovery time (Fast , Slow , Auto , or Off) for the receiver's AGC system. | - No function |
| 9 | PWR Press the A key to select the transmitter power output level (Low 1 , Low 2 , Low 3 , or High). | MTR Press the B key to select the display function of the meter in the transmit mode (Power, ALC, SWR, or MOD indication). | - No function |
| 10 | VOX Press the A key to enable the VOX (voice-operated transmitter switching system) in the SSB, AM, and FM modes. Press and hold in the A key for 1/2 second to recall Menu #51 (for setting the VOX Gain level). | BK Press the B key to activate CW "Semi" Break-in operation. Press and hold in the B key for 1/2 second to recall Menu #17 (for setting the CW Delay time). At a setting of 10 ms, operation emulates full QSK performance. | KYR Press the C key to activate the built-in Electronic Keyer. Press and hold in the C key for 1/2 second to recall Menu #21 (for setting the Keyer speed). |
| 11 | CHG Press the A key to initiate Battery Charging. Press and hold in the A key for 1/2 second to recall Menu #11 (for selecting the Charging period). | VLT Press the B key to display the current battery voltage. | DSP Press the C key to switch the display between the <i>Large Character</i> and <i>Small Character</i> modes. |
| 12 | TCH Press the A key to initiate Tone Search. | DCH Press the B key to initiate DCS Search. | - No function |

* The Operating Function number in this column does not appear on the LCD.

Display Icons

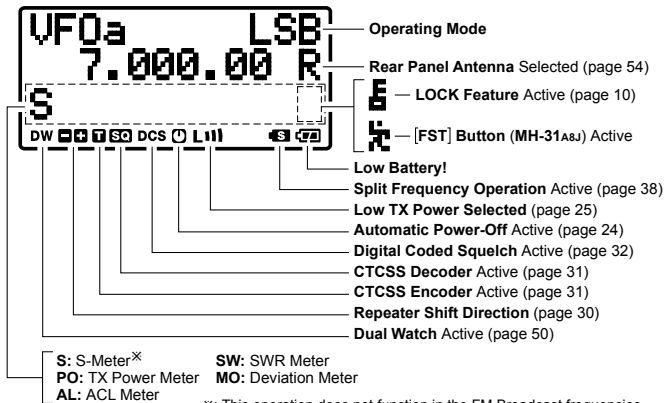

Side Panel Switch & Connectors

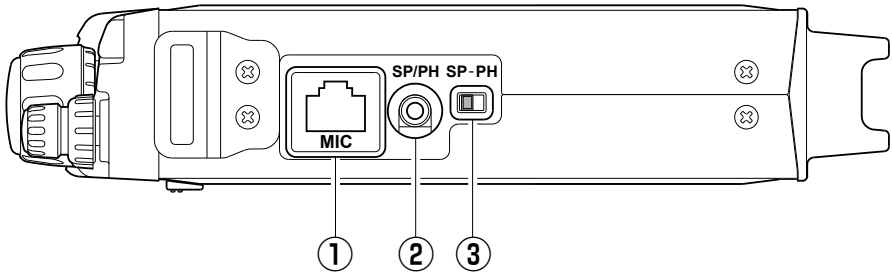

① MIC Jack

Connect the supplied **MH-31A8J** Hand Microphone to this jack.

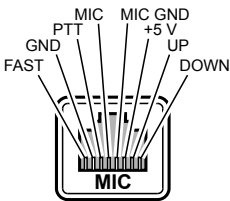

② SP/PH Jack

This 3.5-mm, 2-pin jack provides variable audio output for an external speaker (4Ω - 16Ω impedance) or earphones. The audio level varies according to the setting of the front panel's **AF** knob.



When you insert an earphone plug into this jack, the **SP-PH** slide switch (located to the right side of this jack) **MUST BE** set to the “**PH**” position, to prevent the possibility of injury to your ears.

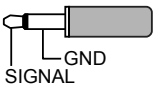

③ SP-PH Switch

If you use earphones with this transceiver, move this switch to the “**PH**” position before inserting the earphone plug into the **SP/PH** Jack, to prevent injury your ears.

Rear Panel Connectors

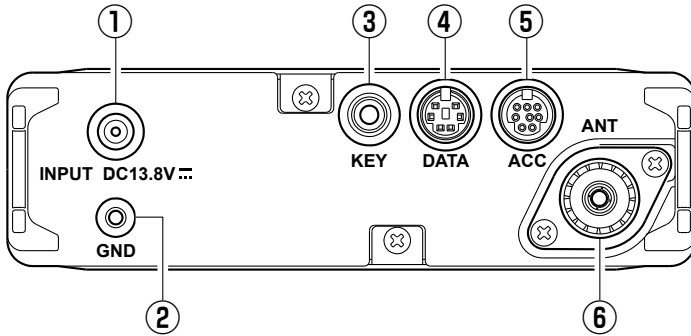

① INPUT:13.8V \equiv Jack (+ -)

This is the DC power supply connection for the transceiver, used when operating the transceiver with an external power supply. Use the supplied DC cable to connect this jack to the car battery or base station DC power supply, which must be capable of supplying at least 3A @ 8 - 16 VDC. This jack is also used for battery charging (when using the supplied **SBR-32MH** battery pack).

② GND Terminal

For best performance and safety, this Ground lug may be connected to a good earth ground using a short, heavy, braided cable.

③ KEY Jack

This 3.5-mm, 3-pin jack is used for connection to a CW keyer paddle or a straight key.

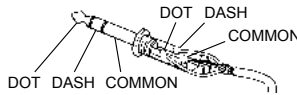

When connecting an electronic keyer paddle

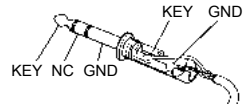

When connecting a single straight key

④ DATA Jack

This 6-pin, mini-DIN jack accepts AFSK input from a Terminal Node Controller (TNC); it also provides fixed-level Receiver Audio Output, Push-To-Talk (PTT), Squelch Status, and ground lines.



⑤ ACC Jack

This 8-pin, mini-DIN jack provides a closure to ground during transmission, ALC, a transmitter-inhibit pin, and “band data” for connection to an external amplifier. It is also used for Transceiver-to Transceiver Cloning and for control of this transceiver using a personal computer.

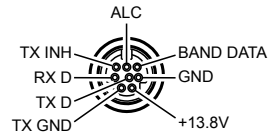

⑥ ANT Jack

Connect your HF and/or 50 MHz antenna's 50-ohm coaxial cable to this M-type (“SO-239”) connector. In its default setting, this jack does not function on 50/144/430 MHz bands. If you want to enable this jack on 50/144/430 MHz bands, recall and change the settings of Menu #07.

Operation

Turning the Transceiver On and Off

1. To turn the transceiver on, press and hold in the **PWR** switch for one second.
2. To turn the transceiver off, again press and hold in the **PWR** switch for one second.

The one-second delay helps you avoid accidental switching on (or off) of DC power.

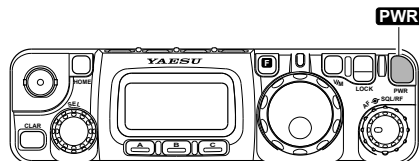

Supply Voltage Display

When you turn on the transceiver, the DC supply voltage is indicated in the upper left corner of the LCD for two seconds. After this interval, the display will resume its normal indication of the operating mode (VFOa, VFOb, or Memory Channel Number).

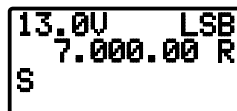

To view the supply voltage at any time during operation:

1. Press the **F** key momentarily, then rotate the **SEL** knob to select Operating Function Row 11* [CHG, VLT, DSP] on the display.
2. Press the **B** (VLT) key momentarily to display the supply voltage in the upper right corner of the LCD.
3. To cancel the supply voltage display, again press the **B** (VLT) key.

Remember, the Operating Row Number does not appear on the display.

If you have not operated your **FT-818** within the past week, we recommend that you plug in the Battery Charger, and perform a 10 hour (use for **PA-48B/C/U**) charge cycle, to ensure that the **SBR-32MH** is ready for operation when you are.

Operating Band Selection

This transceiver covers an incredibly wide frequency range, over which a number of different operating modes are used. Therefore, this transceiver's frequency coverage has been divided into different operating bands, each of which has its own preset channel steps and operating modes. You can change the channel steps and operating mode once you get started, of course, per the next section.

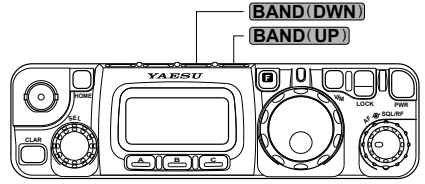

To change the frequency band, press either the **BAND(DWN)** or **BAND(UP)** key to move to the next lower or higher operating band, respectively.

1.8 MHz ↔ 3.5 MHz ↔ 5.0 MHz ↔ 7.0 MHz ↔ 10 MHz ↔ 14 MHz ↔ 15 MHz ↔ 18 MHz
 ↓
 430 MHz ↔ 144 MHz ↔ 108 MHz ↔ 88 MHz ↔ 50 MHz ↔ 28 MHz ↔ 24 MHz ↔ 21 MHz
 ↑

- 1) **Recalling the 5 MHz band (U.S. model) requires different procedure. See page 20 for details.**
- 2) **VFOa and VFOb are independent VFOs, so they may be set to different bands. See the “Stacked VFO System” discussion on page 19 for details.**

Mode Selection

Press either the **MODE(◀)** or **MODE(▶)** key to move among the eight settings for the operating modes, respectively.

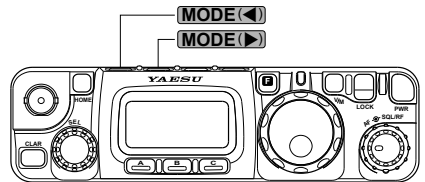
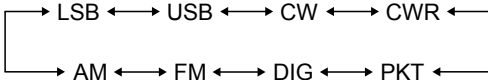

You can also set VFOa and VFOb to different modes in the same band, allowing you to have a “Phone” VFO and a “CW” VFO, for example.

Adjusting the Audio Volume Level

Rotate the **AF** knob to set a comfortable listening level.

When operating in the “DIG” or “PKT” modes, you may set the **AF** knob to any comfortable setting, or even all the way off, because the output from the **DATA** jack is a fixed-level audio signal.

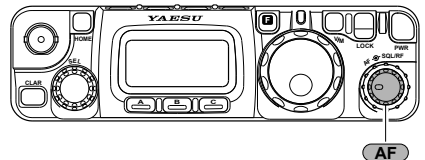

Start with the **AF knob set fully counter-clockwise, especially when using FM (the background noise on FM can be surprisingly loud)!**

Operation

Menu Quick Start

Many aspects of this transceiver's configuration may be customized using the convenient "Menu" system, which allow you to configure many "set and forget" settings just the way you want to. A full discussion of the Menu system beings on page 52; for now, here is a brief discussion on how to change Menu settings:

1. Press and hold in the **[F]** key for one second to enter the Menu mode.
2. Rotate the **[SEL]** knob to recall the Menu item to be changed (for example, Menu #01, which Enables or Disables the Automatic Repeater Shift on the 144 MHz band).
3. Rotate the **[DIAL]** knob to set this feature (in this example, the default setting is "ENABLE," so rotate the **[DIAL]** knob to set this feature to "DISABLE".
4. Press and hold in the **[F]** key for one second to save the new setting and exit to normal operation.

*If you have momentarily pressed the **[F]** key to change an operating function, press the **[F]** key momentarily again (to clear the function indications for the **[A]**, **[B]**, **[C]** keys) before engaging the Menu.*

Adjusting the RF Gain and Squelch

The **[SQL/RF]** control is configured differently, depending on the country to which the **FT-818** has been exported. In the U.S. version, the default function of this control is "**RF Gain**". The configuration of the **[SQL/RF]** control is set via Menu #45; see page 61 for details.

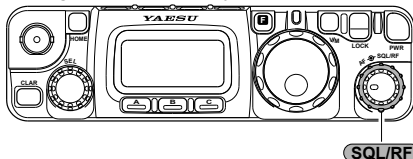

If your transceiver is configured for "**RF Gain**" use, rotating this control fully clockwise in the SSB/CW/Digital modes will provide best sensitivity. To reduce the receiver's RF Gain somewhat, rotate this control counter-clockwise slightly. You will observe an increasing number of bars on the S-meter as you rotate the **[SQL/RF]** control counter-clockwise; this indicates increasing AGC voltage, which is causing the front-end gain to be reduced. In the FM and Packet modes, this control will automatically be set to an "**Auto-Squelch**" mode, wherein the FM/Packet squelch threshold is preset at the factory; the **[SQL/RF]** control still acts as an "**RF Gain**" control, however, and it normally should be set fully clockwise.

If this control is configured for "**SQL**" operation, the **FT-818**'s RF Gain will be set for maximum sensitivity in all modes, and the **[SQL/RF]** control will function solely as a Squelch control. In this case, rotate the **[SQL/RF]** control to the point where the background noise is just silenced; this will provide the best sensitivity to weak signals, while keeping the receiver quiet when no signal is received. The LED just above the Main Dial will glow Green when the squelch is opened by an incoming signal or noise.

Note: *Squelch operation does not function in the FM Broadcast frequencies.*

Battery consumption is significantly reduced if the receiver is squelched, as the audio amplifier stage is shut off when the receiver is muted.

Setting the Operating Frequency

1. In the “SSB/CW/DIG” modes, rotate the **DIAL** knob to set the frequency. Clockwise rotation of the **DIAL** knob increases the operating frequency.
2. In the “AM/FM/PKT” modes, rotate the **SEL** knob to set the frequency. Clockwise rotation of the **SEL** knob increases the operating frequency.
3. You may also use the **SEL** knob to adjust the operating frequency in the “SSB/CW/DIG” modes. The **SEL** knob provides faster tuning, ideal for making quick changes in frequency when you want to move across the band in a hurry. You can then use the **DIAL** knob to make fine frequency adjustments.
4. If you press the **SEL** knob momentarily, then rotate the **SEL** knob, you can now change the operating frequency in 1 MHz steps, allowing very quick frequency excursions. This can be particularly helpful on the VHF and UHF bands.
5. In step 2 above, it was mentioned that tuning in the “AM/FM/PKT” modes is accomplished using the **SEL** knob. By default, the **DIAL** knob is disabled in these modes; if you wish to enable the **DIAL** knob in these modes, use Menu #04; see page 54.
6. The synthesizer steps for the **SEL** knob may be adjusted independently by mode. Use Menu #06 for AM, #30 for FM, and #47 for SSB/CW/Digital. See pages 54, 58, and 61 for details.

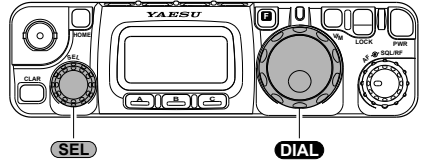

*The main **DIAL** knob synthesizer's tuning rate (the number of steps per rotation of the **DIAL** knob) can be adjusted using Menu #33. See page 59 for details.*

Stacked VFO System

1. Press the **F** key momentarily, then rotate the **SEL** knob, as needed, until Operating Function Row 1 [A/B, A=B, SPL] appears on the display.
2. Now press the **A** (A/B) key to toggle between the “A” and “B” VFOs. There are two such VFOs provided on each Amateur band, so you may set VFO-A to the CW sub-band, and VFO-B to the SSB sub-band, if you like. The operating mode will be preserved, along with the frequency information, on each VFO.

Operation

Operation on 5 MHz Band (U.S. Version Only)

The **FT-818** includes the capability for transmission and reception on the five spot frequencies assigned to the Amateur Service in the United States. To operate on the 5 MHz band:

1. Press the **[V/M]** key once to enter the “Memory” mode (a memory channel number “M-*nnn*” will appear on the display in the space previously occupied by “VFOa” or “VFOb”).
2. Rotate the **[SEL]** knob to select the desired channel (“M-601” through “M-605”), at the factory, with the permitted frequencies in the 5 MHz band.

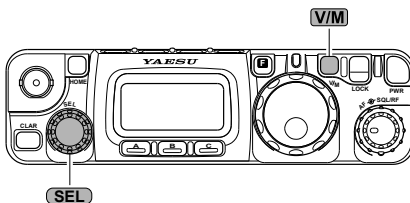

M-601 USB
5.332.00 R
S

Memory Group “OFF”

1-001 USB
5.332.00 R
S

Memory Group “ON”

If you have partitioned your memory channels into Memory Groups via Menu #34, the memory channel numbers for 60-meter operation will be displayed as “I-001” ~ “I-005”. See page 42 for details regarding Memory Group operation, and page 59 for details regarding Menu #34.

3. Pressing the **[MODE<|>]** or **[MODE>|<]** key momentarily, switches the operating mode between SSB and CW.
4. To exit from 60-meter operation and return to the VFO mode, just press the **[V/M]** key (the memory channel number will be replaced by “VFOa” or “VFOb”).

| CH No. | Frequency |
|--------|------------|
| M-601 | 5.3320 MHz |
| M-602 | 5.3480 MHz |
| M-603 | 5.3585 MHz |
| M-604 | 5.3730 MHz |
| M-605 | 5.4050 MHz |

The frequencies and operating mode for 5 MHz band operation are both fixed, and may not be changed.

PSK Operation on 5 MHz Band

1. Press the **[V/M]** key once, if necessary, to enter the “Memory” mode.
2. Rotate the **[SEL]** knob to select the desired channel (“M-601” through “M-605”), at the factory, with the permitted frequencies in the 5 MHz band.
3. Press the **[MODE<|>]** or **[MODE>|<]** key to select the SSB mode.
4. When the “transmit” command is received from the TNC, the **FT-818** transmitter will be engaged. The microphone input is disabled automatically when transmitting the PSK signal.

Likewise, the TNC “receive” command will cause the radio to revert to the receive mode.

You can adjust DATA input level using Menu #25 [DIG MIC].

During PSK operation via the rear panel DATA jack, the front panel MIC jack is cut off, so you won’t have a “live microphone” problem during data operation.

Set the PSK sub carrier frequency of the TNC to 1.5 kHz.

Clarifier (Receiver Incremental Tuning)

The Clarifier allows you to set an offset of up to ± 9.99 kHz of the receive frequency relative to your transmit frequency. To achieve a wider offset than this, you may use the “Split” operating mode, described later.

1. Press the **CLAR** switch momentarily to activate the Clarifier function.
2. Turn the **SEL** knob, which allows the receiver frequency to be varied over a range of 9.99 kHz.
3. When the receiving frequency is higher than transmit frequency, the “↑” icon will appear at the right of the frequency display. Similarly, when the receiving frequency is lower than transmit frequency, the “↓” icon will appear at the right of the frequency display.
4. When the receiving frequency is equal to transmit frequency (Clarifier offset is zero) while the Clarifier is activated, the “-” icon will appear at the right of the frequency display.
5. To turn the Clarifier off, again press the **CLAR** switch momentarily. When you turn the Clarifier back on, the offset previously stored will still be applied.
6. To reset the Clarifier offset to zero, turn the Clarifier off, then turn the **DIAL** knob by any amount. The Clarifier will reset to zero after the first “step” of the **DIAL** knob.

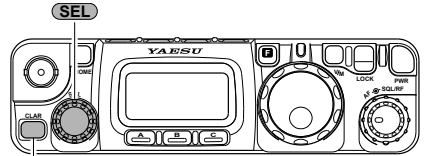

```
WFOa     LSB  
7.000.32↑R  
S
```

[TX < RX]

```
WFOa     LSB  
6.999.03↓R  
S
```

[TX > RX]

```
WFOa     LSB  
7.000.00-R  
S
```



[TX = RX]

If you leave the Clarifier on, moving the **DIAL** knob will not cause the offset to be cancelled.

Receiver Accessories

IF SHIFT

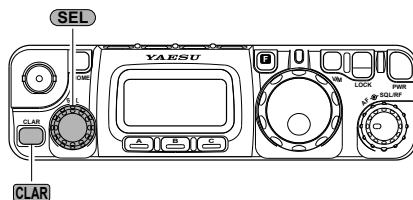
The receiver's IF SHIFT feature is an effective interference-reduction tool, which allows you to shift the passband response higher or lower without changing the pitch of the incoming signal.

1. Press the **CLAR** switch for one second to activate the IF SHIFT feature. A “A line drawing of the receiver's control panel. The panel includes a speaker on the left, a central LCD display, and various control knobs and buttons on the right. A callout box labeled 'SEL' points to a large rotary knob. Another callout box labeled 'CLAR' points to a small rectangular switch located below the speaker.

| | |
|-----------|-----|
| UFOa | USB |
| 14.250.00 | ±R |
| S | |

| | |
|-----------|-----|
| UFOa | USB |
| 14.250.00 | •R |
| S | |

| | |
|-----------|-----|
| UFOa | USB |
| 14.250.00 | ∓R |
| S | |

Engaging of the IF Shift feature does not disable the setting of the Clarifier control. With the IF Shift activated, press the **CLAR switch momentarily to switch to Clarifier operation.**

AGC (Automatic Gain Control)

The receiver recovery time constant of the AGC system may be modified to match your operating needs.

1. Press the **F** key momentarily, then rotate the **SEL** knob, as needed, until Operating Function Row 8 [NB, AGC] appears on the display.
2. Press the **B** (AGC) key to toggle the AGC recovery time constant among the following selections:
“AGCauto” → “AGCfast” → “AGCslow” → “AGCoff” → “AGCauto”
where “AGCauto” represents “AGCfast” on CW and DIG(AFSK), and “AGCslow” on the voice modes.

If “AGCoff” selected, the S-meter (which monitors AGC voltage) will cease to function.

Noise Blanker

The IF Noise Blanker may be useful in reducing or eliminating some types of impulse noise, especially noise generated by automotive ignition systems.

1. Press the **F** key momentarily, then rotate the **SEL** knob, as needed, until Operating Function Row 8 [NB, AGC] appears on the display.
2. Press the **A** (NB) key to activate the Noise Blanker. The “▶” icon will appear at the right of the “NB” indication.
3. Press the **A** (NB) key again to turn the Noise Blanker off.

IPO (Intercept Point Optimization)

The IPO feature bypasses the receiver RF preamplifier, thereby eliminating the preamp’s gain. This feature is not available on the 144 MHz and 430 MHz.

1. Press the **F** key momentarily, then rotate the **SEL** knob, as needed, until Operating Function Row 7 [IPO, ATT, NAR] appears on the display.
2. Press the **A** (IPO) key to bypass the receiver input preamplifier. The “▶” icon will appear at the right of the “IPO” indication.
3. Press the **A** (IPO) key once more to re-activate the preamp.

On the bands below 14 MHz, the input preamplifier is rarely necessary, and activation of the IPO feature will provide substantial protection against intermodulation and other problems associated with strong signal input to the receiver. Rule of thumb: so long as the S-meter is moving on background noise, additional front-end gain is not necessary.

ATT (Front End Attenuator)

The Attenuator will reduce all signals (and noise) by 10 dB, and it may be used to make reception more pleasant under extremely noisy conditions. This feature is not available on the 144 MHz and 430 MHz.

1. Press the **F** key momentarily, then rotate the **SEL** knob, as needed, until Operating Function Row 7 [IPO, ATT, NAR] appears on the display.
2. Press the **B** (ATT) key to activate the Attenuator. The “▶” icon will appear at the right of the “ATT” indication.
3. Press the **B** (ATT) key once more to switch the Attenuator out of the receiver front end circuit.

Receiver Accessories

AM/FM DIAL

In the AM and FM modes, the **DIAL** knob is locked out (via the setting of Menu #04) so as to allow “channelized” tuning on these modes. To adjust the operating frequency, rotate the **SEL** knob.

If you wish to enable the **DIAL** knob for tuning in the AM and FM modes, change the setting of Menu #04. See page 54 for details.

*The “channelized” mode of tuning on AM and FM automatically rounds off the frequency to the next “logical” step when you rotate the **SEL** knob one “click” in either direction. This eliminates the inconvenience of having to preset the frequency to an “even” channel.*

Automatic Power-Off Feature

The APO feature helps conserve battery life by automatically turning the transceiver off after a user-defined period of time within which there has been no dial or key activity. The available selections for the time before power-off are 1 ~ 6 hours, as well as “APO Off”. The default condition for the APO is OFF, and here is the procedure for activating it:

1. Press and hold the **F** key for one second to enter the Menu mode.
2. Rotate the **SEL** knob to recall Menu #08 (APO TIME).
3. Rotate the **DIAL** knob to select the desired time period after which the radio will automatically shut down.
4. Press and hold the **F** key for one second to save the new setting and exit to normal operation.

Once you have programmed a time interval, the APO countdown timer will start whenever some front panel action (tuning, transmission, etc.) is completed.

When the APO is activated, the “**O**” icon will appear at the center bottom on the LCD. If there is no action by you within the time interval programmed, the microprocessor will shut down the radio automatically.

Just press and hold in the **PWR** switch for one second to turn the transceiver back on after an APO shutdown, as usual.

SSB Transmission

Basic Setup/Operation

1. Press the **MODE** (◀) / **MODE** (▶) key so as to select either SSB (LSB/USB) mode. If you are operating on the 7 MHz or lower bands, select the LSB mode. If you are operating on the 14 MHz or higher bands, select the USB mode.
2. Press the **F** key momentarily, then rotate the **SEL** knob, as needed, until Operating Function Row 9 [PWR, MTR] appears on the display, then press the **B** (MTR) key to select the “ALC” meter function (“alc” will appear at the right side of the “MTR” icon).
3. Press the microphone’s **PTT** switch, and speak into the microphone in a normal voice while watching the meter. The ideal audio input level to the transmitter from the microphone will cause a few “segments” of indication on the ALC meter. Release the **PTT** switch to return to receive mode.
4. If the ALC meter is too high, or too low, you may need to reset the Microphone Gain:
 - ① Press and hold in the **F** key for one second to enter the Menu mode.
 - ② Rotate the **SEL** knob to recall Menu #46 (SSB MIC).
 - ③ Close the **PTT** switch, and while speaking into the microphone rotate the **DIAL** knob until the proper ALC indication is achieved on voice peaks.
 - ④ When done, press and hold in the **F** key to save the new setting for the Microphone Gain.

The [TONE] switch on the back of the MH-31A8J microphone provides adjustment of the microphone’s frequency response. Setting this switch to the “2” position will roll off some of the bass response, resulting in improved “talk power” in many instances. The “1” position is primarily used in countries like Japan, where vowel sounds are of critical importance in conveying information; in Western languages, consonant sounds (which are rich in high-frequency components) are frequently more important.

Adjusting the Transmitter Power Output

Four power levels are available on the **FT-818**: 6 Watts, 5 Watts, 2.5 Watt, and 1.0 Watt. When using Alkaline batteries or the supplied **SBR-32MH** Ni-MH Battery Pack, the microprocessor, detecting internal battery use, automatically sets the power level to 2.5 Watts, which appears on the display as “LII”. If you set the power to 6 watts, the power level icon is the same as for 2.5 Watt operation, but at 6 Watts the icon is blinking. For 1 Watt, there is one “bar” to the right of the “L” in the power icon, and for 5.0 Watts there are three “bars” displayed.

The power level is easy to change:

1. Press the **F** key momentarily, then rotate the **DIAL** knob to select Operating Function Row 9 [PWR, MTR].
2. Press the **A** (PWR) key, as needed, to set the desired power level. The icon will change, based on the power level you have set.

| High | Low 3 | Low 2 | Low 1 |
|---------------|-----------------|-----------------|-----------------|
| - | LIII | LII | LI |
| 6 W (AM: 2 W) | 5 W (AM: 1.7 W) | 2.5 W (AM: 1 W) | 1 W (AM: 0.7 W) |

Transmitter Operation

VOX Operation

The VOX system provides automatic transmit/receive switching based on voice input to the microphone. With the VOX system enabled, you do not need to press the **PTT** switch in order to transmit.

1. Press the **F** key momentarily, then rotate the **SEL** knob, as needed, until Operating Function Row 10 [VOX, BK, KYR] appears on the display.
2. Press the **A** (VOX) key to activate the VOX circuitry. The “▶” icon will appear at the right of the “VOX” indication.
3. Without pressing the **PTT** switch, speak into the microphone in a normal voice level. When you start speaking, the transmitter should be activated automatically. When you finish speaking, the transceiver should return to the receive mode (after a short delay).
4. To cancel VOX and return to **PTT** operation., again press the **A** (VOX) key. The “▶” icon will disappear.
5. The VOX Gain may be adjusted, so as to prevent accidental transmitter activation in a noisy environment. To adjust the VOX Gain:
 - ① While still in Operating Row 10 [VOX, BK, KYR], press and hold in the **A** (VOX) key for one second. This is a “hot key” feature which will instantly recall Menu #51 (VOX GAIN).
 - ② While speaking into the microphone, rotate the **DIAL** knob to the point where the transmitter is quickly activated by your voice, without causing background noise to activate the transmitter.
 - ③ When you have selected the optimum setting, press and hold the **F** key for one second to save the new settings and return to normal operation.
6. The “Hang-Time” of the VOX system (the transmit-receive delay after the cessation of speech) may also be adjusted via the Menu. The default delay is 1/2 second. To set a different delay time:
 - ① Press and hold in the **F** key for one second to activate the Menu mode.
 - ② Rotate the **SEL** knob to select Menu #50 (VOX DELAY).
 - ③ Rotate the **DIAL** knob while saying a brief syllable like “Ah” so as to set the desired delay time.
 - ④ When your adjustments are complete, press and hold in the **F** key for one second to save the new setting and return to normal operation.

The delay time for return to the receive mode is set independently on CW and voice modes; for CW, use Menu #17 (see next section).

CW Transmission

Operation using Straight Key/External Keying Device

When using a straight key, an external electronic keyer, or a computer-generated keying device, please follow the instructions in this section.

1. Insert your key's (three-conductor) plug into the rear-panel **KEY** jack.
2. Press the **MODE** (◀) / **MODE** (▶) key, as needed, to select one of the CW (CW/CWR) modes.

The "CW" mode utilizes USB-side carrier injection, while the CWR (Reverse) mode utilizes LSB-side injection.

3. Press the **F** key momentarily, then rotate the **SEL** knob, as needed, until Operating Function Row 10 [VOX, BK, KYR] appears on the display.
4. Press the **B** (BK) key, as needed, to activate "Semi Break-In" operation. The "▶" icon will appear at the right of the "BK" indication.
5. The CW hang time can be adjusted using Menu #17 (CW DELAY). To adjust the CW hang time:
 - ① Press and hold in the **F** key for one second to enter the Menu mode.
 - ② Rotate the **SEL** knob to select Menu #17 (CW DELAY).
 - ③ Rotate the **DIAL** knob to select a longer or shorter delay time (default: 250 ms). This transceiver was not expressly designed for "full QSK" operation, the minimum (10 ms) setting of this Menu item (CW DELAY) will be very close to full break-in performance.
 - ④ When done, press and hold in the **F** key for one second to save the new setting and exit to normal operation.

If you are already in Operating Function Row 10 [VOX, BK, KYR], pressing and holding in the **B (BK) key for one second will instantly select Menu #17 (CW DELAY).**

6. To practice your CW sending (without transmitting), press the **B** (BK) key to make the "▶" icon disappear. Now, pressing the key will cause the CW sidetone to be heard, but your radio will not be transmitting a signal on the air.
7. You can adjust the CW sidetone volume level via Menu #44 (SIDETONE). To adjust the CW sidetone volume level:
 - ① Press and hold in the **F** key for one second to enter the Menu mode.
 - ② Rotate the **SEL** knob to select Menu #44 (SIDETONE).
 - ③ Rotate the **DIAL** knob to select a new level; on the arbitrary scale of "0" ~ "100," the default value is "50".
 - ④ When done, press and hold in the **F** key for one second to save the new setting and exit to normal operation.

Transmitter Operation

8. You also can adjust the CW sidetone pitch using Menu #20 (CW PITCH). This adjustment also controls the BFO offset (actual pitch of your transmitted signal relative to your current receive frequency). To adjust the CW sidetone pitch:
- ① Press and hold in the **F** key for one second to enter the Menu mode.
 - ② Rotate the **SEL** knob to select Menu #20 (CW PITCH).
 - ③ Rotate the **DIAL** knob to select a new pitch tone/BFO offset. The available offset range is 300 ~ 1000 Hz (default value is “700 Hz”).
 - ④ When done, press and hold in the **F** key for one second to save the new setting and exit to normal operation.

Because the CW Pitch corresponds to the actual pitch of your transmitted signal, the sidetone may be used in a “CW Spot” capacity. Just tune the pitch of the received signal to the same pitch as that of your transceiver’s sidetone, and you will be perfectly “zero beat” with the other station.

The FT-818 can generate a “CW Spot” tone; just press and hold in the **HOME** key while in the CW mode.

Operation using Built-in Electronic Keyer

The built-in Electronic Keyer provides a convenient method of generating CW. The Electronic Keyer includes weight and speed adjustments.

1. Connect your keyer paddle's cable to the **KEY** jack on the rear panel of the transceiver.
2. Press the **MODE**(◀) / **MODE**(▶) key, as needed, to select the CW (CW/CWR) mode.
3. Press the **F** key momentarily, then rotate the **SEL** knob, as needed, until Operating Function Row 10 [VOX, BK, KYR] appears on the display.
4. Press the **C** (KYR) key to activate the Electronic Keyer. The “▶” icon will appear at the right of the “KYR” indication.
5. The Keyer speed may be adjusted using Menu #21 (CW SPEED). To adjust the Keyer speed:
 - ① Press and hold in the **F** key for one second to enter the Menu mode.
 - ② Rotate the **SEL** knob to select Menu #21 (CW SPEED).
 - ③ Press the **SEL** knob if you wish to select display of “cpm” (characters per minute) instead of “wpm” (words per minute). The “cpm” selection is based on the international “PARIS” standard, which stipulates five characters per word.
 - ④ Rotate the **DIAL** knob, while sending, to set the desired sending speed.
 - ⑤ When done, press and hold in the **F** key for one second to save the new setting and exit to normal operation.

If you are already using Operating Function Row 10 [VOX, BK, KYR], press and hold in the [C](KYR) key to switch instantly to Menu #21 (CW SPEED).

6. The Dot:Dash weighting ratio may be adjusted via Menu #22 (CW WEIGHT). To adjust the Dot:Dash weighting ratio:
 - ① Press and hold in the **F** key for one second to enter the Menu mode.
 - ② Rotate the **SEL** knob to select Menu #22 (CW WEIGHT).
 - ③ Rotate the **DIAL** knob to set the desired weight.
 - ④ When done, press and hold in the **F** key for one second to save the new setting and exit to normal operation.
7. You may select “normal” or “reverse” paddle polarity via Menu #19 (CW PADDLE). The default setting for this feature is “normal,” whereby the “Tip” connection on the Key Plug is “Dot” and the “Ring” connection is “Dash”. To change the paddle polarity:
 - ① Press and hold in the **F** key for one second to enter the Menu mode.
 - ② Rotate the **SEL** knob to select Menu #19 (CW PADDLE).
 - ③ Rotate the **DIAL** knob to select the new setting.
 - ④ When done, press and hold in the **F** key for one second to save the new setting and exit to normal operation.

Transmitter Operation

FM Transmission

Basic Setup/Operation

1. Press the **MODE** (◀) / **MODE** (▶) key so as to select the FM mode.
2. Press the microphone's **PTT** switch, and speak into the microphone in a normal voice.
3. Release the **PTT** switch to return to the receive mode.
4. If you get reports that your modulation level is too high or too low, you may need to adjust the FM-mode microphone gain. The procedure is similar to that used on SSB:
 - ① Press the **F** key momentarily, then rotate the **SEL** knob, as needed, until Operating Function Row 9 [PWR, MTR] appears on the display, then press the **B** (MTR) key to select the "Deviation" meter function ("mod" will appear at the right side of the "MTR" icon).
 - ② Press and hold in the **F** key for one second to enter the Menu mode.
 - ③ Rotate the **SEL** knob to recall Menu #29 (FM MIC).
 - ④ Increase or decrease the setting of the FM Mic Gain, depending on the level correction required, then press and hold the **F** key to save the new setting.
 - ⑤ Close the PTT switch, and while speaking into the microphone observe the meter indication; the proper setting of the FM Mic Gain will produce five "bars" of indication on voice peaks, slightly less on lower levels of speech input.
 - ⑥ When done, press and hold in the **F** key to save the new setting for the FM-mode microphone gain.
5. The VOX feature is operational during FM transmission. From Operating Function Row 10 [VOX, BK, KYR], press the **A** (VOX) key to activate/deactivate VOX.

Repeater Operation

1. Press the **F** key momentarily, then rotate the **SEL** knob, as needed, until Operating Function Row 4 [RPT, REV, TON] appears on the display.
2. Press the **A** (RPT) key to activate repeater operation. One press of the **A** (RPT) key will have set the transceiver for "Minus Shift" operation. In this situation, you will observe the "-" indicator on the display. The transmitter frequency will be shifted down by a default value so as to access the repeater input frequency. If your repeater uses a positive shift (instead of negative), press the **A** (RPT) key again; the "+" indicator will replace the "-" indicator on the display.
3. If the default repeater shift is not appropriate for your area, it may be set independently for each band. To change the repeater shifts:
 - ① Press and hold the **A** (RPT) key for one second. This instantly recalls Menu #42 (RPT SHFT).
 - ② Rotate the **DIAL** knob to select the desired shift frequency.
 - ③ When done, press and hold in the **F** key for one second to save the new setting and exit to normal operation.
4. Press the **C** (TON) key to activate the CTCSS tone encoder, which provides a sub-audible repeater access tone. One press of the **C** (TON) key will activate the CTCSS tone encoder. In this situation, you will observe the "T" indicator on the display. If you press the **C** (TON) key repeatedly, you will observe "T SQ" (CTCSS Encode/De-

Transmitter Operation

- code), followed by “**DCS**” (Digital Coded Squelch, Encode/Decode). One additional press will disable all repeater-access tone systems. See the next section for a discussion of DCS operation.
- If the default repeater access tone are not appropriate for your area, it also may be set independently for each band. To change the repeater access tone:
 - Press and hold the **C** (TON) key for one second. This instantly recalls Menu #48 (TONE FREQ).
 - Rotate the **DIAL** knob to select the desired CTCSS frequency.
 - When done, press and hold the **F** key for one second so save the new setting and exit to normal operation.
 - Set the transceiver’s receiver to the repeater output (downlink) frequency.
 - Close the PTT switch and speak into the microphone. You will observe that the transmitted frequency has shifted according to the setting of the **A** (RPT) key.
 - Release the PTT switch to return to the Receive mode.
 - With repeater shift activated, you can temporarily reverse the transmit and receive frequencies by pressing the **B** (REV) key. The “**B**” icon will blink while “Reverse” shift is activated. Press the **B** (REV) key again to revert to the “Normal” shift direction.
 - When you are finished with repeater operation, you may wish to set the repeater shift to simplex by pressing the **A** (RPT) key, and disable the CTCSS or DCS tone by pressing the **C** (TON) key.
 - On many transceiver versions, the Automatic Repeater Shift (ARS) feature is enabled at the factory. This feature automatically activates the appropriate repeater shift when you are operating inside the designated 144 MHz or 430 MHz FM repeater sub-bands in your country. If you wish to change the settings for the ARS, use Menu #01 (144 ARS) or Menu #02 (430 ARS) (see page 54).

If your local repeaters need a 1750-Hz burst tone for access (typically in Europe), press and hold in the front panel’s HOME key to transmit the burst tone.

Tone Search Scanning

In operating situations where you don’t know the CTCSS tone being used by another station, you can command the radio to listen to the incoming signal and scan in search of the tone being used.

To scan for the CTCSS tone in use:

- Press the **F** key momentarily, then rotate the **SEL** knob, as needed, until Operating Function Row 12 [TCH, DCH] appears on the display.
- Press the **A** (TCH) key to activate CTCSS Encoder/Decoder; (the “**T SQ**” icon will appear on the display) and start scanning for the incoming CTCSS tone.
- When the radio detects the correct tone, it will halt on that tone, and audio will be allowed to pass.
- Press and hold in the **A** (TCH) key for one second; the CTCSS tone detected will be stored as the “current” tone, so it may be used for memory storage purposes, and you may now exit to normal operation.

Transmitter Operation

DCS Operation

Another form of tone access control is Digital Code Squelch, or DCS. It is a newer, more advanced tone system that is less susceptible to false triggering than CTCSS. A DCS Encoder/Decoder is built into your transceiver, and operation is very similar to that described above for CTCSS.

1. Set the desired DCS code via Menu #23 (DCS CODE).
2. Press the **F** key momentarily, then rotate the **SEL** knob, as needed, until Operating Function Row 4 [RPT, REV, TON] appears on the display.
3. Press the **C** (TON) key three times to activate the DCS Encoder/Decoder (the “**DCS**” icon will appear on the display). The receiver will remain muted until a matching DCS code is received on an incoming signal.
4. Press the **C** (TON) key once to cancel DCS operation (the “**DCS**” icon will disappear).

DSC Search Scanning

In operating situations where you don't know the DCS code being used by another station, you can command the radio to listen to the incoming signal and scan in search of the code being used.

To scan for the DCS code in use:

1. Press the **F** key momentarily, then rotate the **SEL** knob, as needed, until Operating Function Row 12 [TCH, DCH] appears on the display.
2. Press the **B** (DCH) key to activate DCS Encoder/Decoder; (the “**DCS**” icon will appear on the display) and start scanning for the incoming DCS code.
3. When the radio detects the correct code, it will halt on that code, and audio will be allowed to pass.
4. Press and hold in the **B** (DCH) key for one second; the DCS code detected will be stored as the “current” code, so it may be used for memory storage purposes, and you may now exit to normal operation.

ARTS™ (Auto Range Transpond System) Operation

The ARTS™ system uses DCS signaling to inform you when you and another ARTS™-equipped station are within communications range. This can be especially valuable during search-and-rescue operations, as a base station can quickly use ARTS™ to alert a field unit that it is out of range; the field unit can then move to a better location to re-establish communications.

1. Press the **[F]** key momentarily, then rotate the **[SEL]** knob, as needed, until Operating Function Row 6 [SSM, SCH, ART] appears on the display.
2. Press the **[C]** (ART) key to activate ARTS™ operation.
3. Your display will change to “out range” to indicate the beginning of ARTS™ operation. Every 25 seconds, your radio will transmit a “polling” call to the other station. When that station responds with its return ARTS™ polling signal, your display will change to “in range” to confirm reception of the response.
4. To cancel ARTS operation, press the **[C]** (ART) key again (the “out range” or “in range” indication will disappear from the LCD).



The ARTS™ feature offers a choice of beep options to alert you to the current status of ARTS™ operation. Use Menu #09 (ARTS BEEP) on page 55 to select the beep option that is best for your operating needs.

CW Identifier Setup

The ARTS™ feature includes a CW identifier. When it is activated, the radio will send “**DE (your callsign) K**” in Morse code every ten minutes during ARTS™ operation.

To program the CW IDer, use Menu #31 (ID), as described on page 58. And to activate the CW IDer, use Menu #18 (CW ID).

Transmitter Operation

Digital Mode Operation (SSB-Based AFSK)

The **FT-818** provides extensive capability for digital mode operation on the HF, VHF, and UHF bands. The use of AFSK (Audio Frequency-Shifted Keying) configurations allows a wide variety of different communication modes to be utilized. The Menu provides for specific digital mode selections, which include custom BFO offsets to optimize the receive and transmit passbands for the mode selected.

Before beginning Digital operation, you need to define which Digital mode will be utilized. To do this, use Menu #26 as follows (in this example, we will set up RTTY as the Digital mode):

1. Press and hold in the **[F]** key for one second to enter the Menu mode.
2. Rotate the **[SEL]** knob to select Menu #26 (DIG MODE).
3. Rotate the **[DIAL]** knob to select "RTTY".
4. Press and hold in the **[F]** key for one second to save the new setting and exit.

Use this technique to set up any digital mode.

RTTY (Radio Teletype) Operation

The "RTTY" mode on the **FT-818** is based on LSB-side carrier injection, in accordance with long-standing amateur practice. If you need USB-side injection for your application, see the "User" mode discussion below.

1. Connect your TNC (Terminal Node Controller) or terminal modem to the **FT-818's** rear-panel **DATA** jack, per the illustration.
2. Press the **[MODE<|>]** / **[MODE<|>]** key, as needed, to select the DIG mode (the "DIG" icon will appear on the display). Be certain to use the "TX Audio" line from your TNC, not an "FSK Key" line, for the transmit-data connection.
3. Press the **[MODE<|>]** / **[MODE<|>]** key, as needed, to select the DIG mode (the "DIG" icon will appear on the display). You should now be able to tune around the band, and any RTTY signals heard should be capable of being decoded.

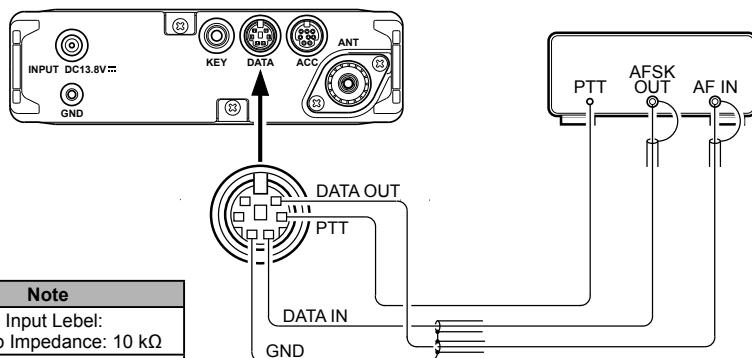

| Pin Label | Note |
|-----------|---|
| DATA IN | Maximum Input Level: 1.0 V pp Impedance: 10 kΩ |
| PTT | Ground to Transmit |
| DATA OUT | Maximum Output Level: 300 mVpp Impedance: 10kΩ |

Transmitter Operation

4. If the optional **YF-122C** 500 Hz filter has been installed, it may be used for RTTY work. Recall Operating Function Row 7 [IPO, ATT, NAR] then press the **C** (NAR) key to engage the narrow filter.
5. To set up the transmit side, be sure that the Meter is set to monitor ALC voltage. If not, press the **F** key momentarily, then rotate the **SEL** knob to select to select Operating Function Row 9 [PWR, MTR], then press the **B** (MTR) key so as to select metering of ALC.
6. Press and hold in the **F** key for 1/2 second to enter the MENU mode, then rotate the **SEL** knob to select Menu #25 (DIG MIC).
7. Following the instructions for your TNC's software, activate the transmitter from the computer keyboard; this should cause the AFSK output from the TNC to be sent to the radio. While transmitting, view the ALC meter; a few "dots" of ALC indication should be observed. If not, rotate the **DIAL** knob to adjust the AFSK level. Press and hold in the **F** key for one second to save the new AFSK level setting and return to normal operation. You are now ready for RTTY operation.

Because RTTY is a continuous-duty transmission mode, try to keep your transmission short when running on battery power, so as to minimize current drain.

PSK31 Operation

Two dedicated PSK31 modes are available, one each for USB-side and LSB-side injection. For BPSK work, the injection does not matter, but for QPSK the two working stations must use the same sideband.

Connect the **FT-818** to your computer's sound card or interface.

Setup for PSK31 operation is basically identical to that previously described for RTTY operation. As before, use the "DIG" mode. However, in Menu #26, select "PSK31-L" (for LSB injection) or "PSK31-U" (for USB injection). As with RTTY, Menu #25 may be used to set the drive to the transmitter. And the **YF-122C** 500 Hz filter may also be utilized, as described previously.

Transmitter Operation

“USER” Defined Digital Modes

Also provided in the **FT-818** are two convenient “USER” Digital modes, one each providing USB- and LSB-side injection, which may be used for SSTV, Fax, Pactor, and other digital operating modes.

Here is an example involving the configuration of the USER mode for RTTY with USB-side injection (as opposed to LSB injection, used in the default “RTTY” mode):

1. Use Menu #26 to set the Digital mode to “USER-U”.
2. Press the **MODE(◀)** / **MODE(▶)** key, as needed, to select the DIG mode (the “DIG” icon will appear on the display).
3. Now use Menu #27 to configure the transceiver’s passband response. Once in the Menu mode, rotate the **SEL** knob to select Menu #27 (DIG SHIFT), and rotate the **DIAL** knob to set the desired BFO offset (depending on how your TNC’s tones are set up). For typical high-frequency tone use, a setting of about “+2100” will be a good starting point.
4. Finally, depending on how you wish the display to respond, you may program in a corresponding display shift, using Menu #24 (DIG DISP). Remember to press and hold in the **F** key for one second when exiting the Menu mode.
5. The setup of the AFSK drive level is identical to that described previously for RTTY operation.

The USER-L and USER-U Digital modes should allow you to operate on any SSB-based AFSK Digital mode. Note that the “PSK31” configurations will also work well for many Digital operating situations.

Transmitter Operation

Packet (1200/9600 bps FM) Operation

The **FT-818** is designed for operation on either 1200 bps or 9600 bps packet, and set-up is similar to that described previously for SSB-based modes. A separate Data input adjustment is provided, allowing you to optimize the deviation on the FM Packet modes separately from the SSB-based Digital modes. The RX-Data output lines are fixed-level outputs, not affected by the setting of the AF Gain control.

1. Connect your TNC to the **FT-818**'s rear-panel **DATA** jack, per the illustration. Note that different connections are used for 1200 bps and 9600 bps Packet.
2. Use Menu #40 (PKT RATE) to select the desired Packet mode. Once you have entered the Menu and have selected Menu #40, rotate the **DIAL** knob to select either "1200" or "9600" (bps) as the Packet rate.
3. Press the **MODE** (◀) / **MODE** (▶) key, as needed, to select the PKT mode (the "PKT" icon will appear on the display).
4. You are now set up for reception on Packet. If you are operating on 1200 bps, try now to connect to another station or node; you may well find that the drive level needs no further adjustment.
5. If you are having trouble connecting due to insufficient or excessive drive from the TNC to the **FT-818**, use Menu #39 (PKT MIC) to set the drive. Use your terminal software's "test" protocol to send out test tones, and adjust the deviation by rotating the **DIAL** knob, which will vary the data input level to the **FT-818**'s modulator. Remember to press and hold in the **F** key for one second when adjustments are completed, so as to save the new setting for Menu #39.

The 9600 bps Packet deviation setting is very critical to successful operation, and it can only be accomplished using a calibrated deviation meter; the optimum setting is usually ± 2.75 kHz (± 0.25 kHz). For 1200 bps, the optimum level is much less critical, with the optimum deviation being between ± 2.5 kHz and ± 3.5 kHz.

| Pin Label | Note |
|----------------------|--|
| DATA IN | Maximum Input Level: 40 mV pp @1200 bps 1.0 V pp @9600 bps Impedance: 10 k Ω |
| PTT | Ground to Transmit |
| DATA OUT 9600 bps | Maximum Output Level: 500 mVpp Impedance: 10k Ω |
| DATA OUT 1200 bps | Maximum Output Level: 300 mVpp Impedance: 10k Ω |
| SQL | SQL Open: +5 V SQL Clised: 0 V |

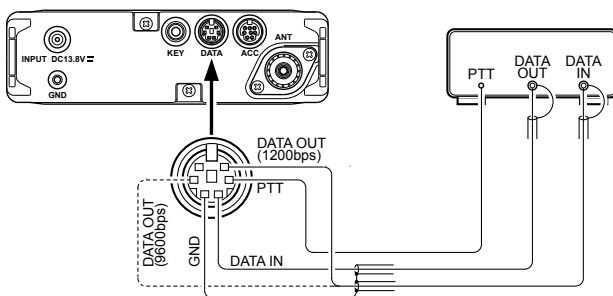

Transmitter Operation

AM Transmission

The **FT-818** utilizes low-level amplitude modulation of an early stage for transmission purposes. This capability is primarily provided for emergency use only, as low-power operation typically utilizes more efficient transmission/reception modes.

The AM carrier level is preset to 2 Watts during alignment at the factory, and should not require further adjustment. It is important to remember that AM transmission requires that power must be distributed among the carrier and voice sidebands; therefore, if excessive carrier power is used, there will be insufficient power available for the information-carrying voice sidebands.

The AM microphone gain is preset at the factory to a value which typically provides good audio. If you need to modify the microphone gain in the AM mode, use Menu #05 (AM MIC). See page 54 for details.

Split Frequency Operation

This transceiver provides convenient split-frequency operation, using the VFO-A and VFO-B, for DX working and other operating situations requiring unique split frequency pairs.

The example below will describe a typical split-frequency DX situation on the 20-meter band, with a DX station transmitting on 14.025 MHz, listening 10 kHz higher in the band.

1. Set VFO-A to 14.035.00 MHz (DX station's listening frequency).
2. Press the **F** key momentarily, then rotate the **SEL** knob, as needed, until Operating Function Row [A/B, A=B, SPL].
3. Press the **A** (A/B) key momentarily to select VFO-B.
4. Tune the VFO-B frequency to 14.025.00 MHz (DX station's transmitting frequency).
5. Press the **C** (SPL) key momentarily. The transceiver will now transmit using the VFO-A frequency, and will receive using the VFO-B frequency. The "**S**" icon will appear on the display.
6. To listen to the pile-up calling the DX station (so as to align your frequency more closely to that of the station being worked by the DX), press the **A** (A/B) key to reverse the VFOs. You will now be tuning in the vicinity of 14.035 MHz, and you can zero in on the DX station's listening frequency by tuning in on the station in QSO with the DX. Press the **A** (A/B) key again to return to reception on the DX station's frequency.
7. Press the **C** (SPL) key once more to cancel split operation; the "**S**" icon will disappear from the display.

Time-Out Timer

Most often used on FM, the transmitter's Time-Out Timer (TOT) feature disables the transmitter after a user-defined period of transmission. This feature may be useful in preventing a "stuck microphone" (accidental closure of the **PTT** switch) from causing interference to other users, and it will also force you to keep your transmission short, thereby conserving battery power.

To activate the Time-Out Timer:

1. Press and hold in the **[F]** key for one second to enter the Menu mode.
2. Rotate the **[SEL]** knob to recall Menu #49 (TOT TIME).
3. The default setting for this feature is "off". Rotate the **[DIAL]** knob to set a new time-out setting (from 1 minute to 20 minutes).
4. When you have made your selection, press and hold in the **[F]** key for one second to save the new setting and exit to normal operation.

Weather Fax Monitoring

Monitoring of HF Weather Fax broadcasts is easily accomplished using the **FT-818**.

1. Before proceeding, be certain that the Weather Fax demodulator is properly connected to Pins 5 (DATA OUT 1200bps) and 2 (GND) of the rear panel **DATA** jack.
2. Set the transceiver to the VFO mode, and set the operating mode to "DIG," setting Menu #26 to PSK31-U, as described previously.
3. Now, select the operating frequency of the station transmitting the Weather Fax broadcast. Note that, in the USB mode, the frequency you should program onto the display is typically 1.90 kHz *below* the station's "assigned" frequency. Thus for a Weather Fax station assigned to 8.682.0 MHz, tune to 8.680.1 MHz.
4. When the Weather Fax broadcast begins, no further operator intervention should be needed from the transceiver standpoint. The audio level from the **DATA** jack on the rear of the transceiver is fixed, and cannot be adjusted.

Fine adjustments in the gray-scale and the frame alignment are accomplished using the computer and software connected to your Weather Fax demodulator.

QMB Channel Storage

1. Tune in the desired frequency and set the operating mode and bandwidth. If this is an FM channel, set up any required CTCSS/DCS and repeater shift configurations.
2. Press and hold in the **[V/M]** key until a *double* “beep” is heard. The second beep provides audible confirmation that the data has been stored into the QMB memory.

Pressing the **[A] (A/B) key momentarily while in Operating Function Row 3 [STO, RCL, PMS] will also store a frequency into the QMB register.**

QMB Channel Recall

1. Press the **[F]** key momentarily, then rotate the **[SEL]** knob, as needed, until Operating Function Row 3 [STO, RCL, PMS] appears on the display.
2. Press the **[B]** (RCL) key momentarily to recall the QMB memory. “QMB” will appear at the upper right corner on the LCD.
3. Press the **[B]** (RCL) key once more to return to the previous frequency (either a VFO frequency or a Memory channel).

If you move the **[DIAL]** knob or **[SEL]** knob while in the QMB mode, you can change frequencies as if you were in a “VFO” mode. You also can change operating mode by pressing the **[MODE<◀]** or **[MODE▶]** key. When this is done, the “MTQMB” will appear in the display, where “MT” represents “Memory Tuning”. Press the **[B]** (RCL) key once more to return to the originally-stored QMB frequency.

Memory Operation on “Regular” Memory Channels

Normal Memory Storage

1. Tune in the desired frequency, and set the operating mode and bandwidth. If this is an FM channel, set up any required CTCSS/DCS and repeater shift configurations. Standard (default) repeater shifts do not require you to utilize the “split” frequency memory technique, described later.
2. Press the **[F]** key momentarily, then rotate the **(SEL)** knob, as needed, until Operating Function Row 2 [MW, MC, TAG] appears on the display.
3. Press the **[A]** (MW) key momentarily to enter the “Memory Check” mode, which is used to find an unused memory channel. The frequency stored (if any) on the *current* memory channel will be shown in the display.
4. Rotate the **(SEL)** knob to select the channel number on which you wish to store the current frequency data.
5. Press and hold in the **[A]** (MW) key for one second until you hear a double beep; the second beep confirms that the frequency information was successfully stored.

Split-Frequency Memory Storage

You can also store “Split” frequencies, such as when operating on a repeater system not utilizing a “standard” offset. This procedure may also be used for DX work on 7 MHz SSB, etc.

1. In the VFO mode, set the desired *Receive* frequency and mode.
2. Press the **[F]** key momentarily, then rotate the **(SEL)** knob, as needed, until Operating Function Row 2 [MW, MC, TAG] appears on the display.
3. Press the **[A]** (MW) key momentarily to enter the “Memory Check” mode, which is used to find an unused memory channel. The frequency stored (if any) on the current memory channel will be shown in the display.
4. Rotate the **(SEL)** knob to select the channel on which you wish to store the receive frequency data.
5. Press and hold in the **[A]** (MW) key for one second until you hear a double beep, which confirms that the *Receive* frequency data is now stored.
6. Now, set the desired *Transmit* frequency and mode on the VFO.
7. Press the **[A]** (MW) key momentarily; **do not** rotate the **(SEL)** knob!
8. While the “memory channel number” is blinking, press and hold in the **PTT** switch; while holding it in, press and hold in the **[A]** (MW) key for one second. The double “beep” will confirm that independent *Transmit* frequency data is now stored. You may now release the **PTT** switch.

In step 8 above, pressing the PTT switch does not activate the transmitter. It simply sends a signal to the microprocessor that an independent Transmit frequency is being stored on the same channel as a previously-stored Receive frequency.

Memory Operation

Memory Channel Recall

1. If you currently are in the VFO tuning mode, press the **V/M** key once to enter the “Memory” mode (a memory channel number “M-*nnn*” will appear on the display in the space previously occupied by “VFOa” or “VFOb”).
2. To select another memory channel, turn the **SEL** knob.
3. When your memory channels are partitioned into Memory Groups via Menu #34, it is easy to change Memory Groups; press the **SEL** knob momentarily (a Group Number (“a” ~ “j”) will blink), then turn the **SEL** knob to step through the channels until you enter another. You may now press the **SEL** knob once more to restrict memory channel access to the newly-selected Group.
4. Once you are operating on a memory channel, you may tune off of the originally-memorized frequency (as though you were in the VFO mode). Just rotate the **DIAL** knob; the “Memory Channel Number” will be replaced by one which indicates “MTUNE,” indicating that you have now shifted into the “Memory Tuning” mode. When operating the Memory Tuning mode, if you find another frequency you wish to store into another memory channel, just press the **A** (MW) key momentarily, select a new memory channel via the **SEL** knob, then press and hold in the **A** (MW) key until you hear the double beep.
5. To exit the Memory Tuning mode, press the **V/M** key as follows:
 - One touch of the **V/M** key returns you to the original memory frequency.
 - A second touch of the **V/M** key will cause you to exit the Memory mode and return to the VFO mode (the memory channel number will be replaced by “VFOa” or “VFOb”).

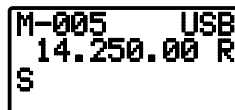

```
M-005   USB
14.250.00 R
$
```

Memory Group “OFF”

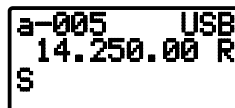

```
a-005   USB
14.250.00 R
$
```

Memory Group “ON”

*When operating on a “Split” frequency memory, a special “**Ⓜ**” indication will appear on the LCD.*

Masking Memory

Frequency data stored on a memory channel can be deleted, if desired, from any memory channel except channel “1”. The deletion process is not a “hard” erasure, so if you erase a channel by mistake using this procedure, the memory channel contents can be recovered.

1. Press the **F** key momentarily, then rotate the **SEL** knob, as needed, until Operating Function Row 2 [MW, MC, TAG] appears on the display.
2. Press the **A** (MW) key momentarily, then rotate the **SEL** knob to select the memory channel to be deleted.
3. Press the **B** (MC) key momentarily. The frequency display field on the LCD will go blank, and the memory channel number will blink.
4. Wait about three seconds; when the memory channel number stops blinking, the data will now be “masked” and will not be available for operation.
5. To restore the masked frequency data, repeat the above steps. However, if you store new frequency information on a channel containing masked data, the masked data will be over-written and lost.
6. Memory Channel 1 is used for Priority operation, and frequency information may only be over-written (not masked) on this channel.

Memory Operation on “HOME” Channel Memories

Four Special one-touch “Home” channels are available, for special frequencies you use often. Either “simplex” or “split” frequency/mode data may be stored in the “Home” channel locations. Special “Home” channels are available for HF (any frequency between 1.8 and 29.7 MHz), 50 MHz, 144 MHz, and 430 MHz.

These memories may prove particularly useful for monitoring propagation beacons, providing one-touch recall of the beacon frequency for a quick check of band conditions.

HOME Channel Storage

1. Tune the desired frequency, and set the operating mode. If this is an FM channel, set up any required CTCSS/DCS and repeater shift configurations.
2. Press the **[F]** key momentarily, then rotate the **[SEL]** knob, as needed, until Operating Function Row 2 [MW, MC, TAG] appears on the display.
3. Press the **[A]** (MW) key momentarily to enter the “Memory Check” mode.
4. Press and hold in the **[HOME]** key for one second. This stores the frequency data into the “Home” channel location. As usual, you will hear a double beep to confirm the successful storage of the frequency data.
5. If you wish to store a “Split” frequency pair into the “Home” channel, store the *Receive* frequency in steps 1 ~ 4 above. Now set the desired *Transmit* frequency.
6. Once more, press the **[A]** (MW) key momentarily.
7. Press and hold in the microphone’s **PTT** switch; while holding the **PTT** switch, again press and hold the **[HOME]** key for one second. This stores the transmit frequency data into the “Home” channel location.

HOME Channel Recall

1. Press the **[HOME]** key momentarily to recall the Home Channel on the band group where you currently are operating (HF, 50 MHz, 144 MHz, or 430 MHz). The “HOME” indication will appear on the display.
2. Press the **[HOME]** key once more to return to the previously-used frequency (either a VFO frequency or a memory channel).

Memory Operation

Labeling Memories

You may wish to append an alpha-numeric “Tag” (label) to a memory or memories, to aid in recollection of the channel’s intended use (such as a club name, etc.). This is easily accomplished using the Menu mode.

1. Recall the memory channel onto which you wish to append a label.
2. Press and hold in the **[F]** key for one second to enter the Menu mode.
3. Rotate the **[SEL]** knob to recall Menu #35 (MEM TAG).
4. Press the **[SEL]** knob to enable the programming of the label.
5. Rotate the **[DIAL]** knob to select the first character (number, letter, or symbol) in the name you wish to store, then rotate the **[SEL]** knob clockwise to move to the next character.
6. Again rotate the **[DIAL]** knob to select the next number, letter, or symbol, then rotate the **[SEL]** knob clockwise to move to the next character’s slot.
7. Repeat step 6 as many times as necessary to complete the name tag for the memory, then press and hold in the **[F]** key for one second to save the A/N (Alpha-Numeric) name entry and exit to normal operation.

During Memory operation, press the **[F]** key momentarily, then rotate the **[SEL]** knob, as needed, until Operating Function Row 2 [MW, MC, TAG] appears on the display. Press the **[C]** (TAG) key momentarily to activate the alpha-numeric Tag. Repeatedly pressing this key will toggle operation between “Frequency” display and “Tag” display.

You can recall Menu #35 (MEM TAG) instantly by pressing and holding in the **[C] (TAG) key for one second.**

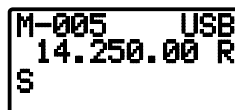

M-005 USB
14.250.00 R
S

“Frequency” Display



M-005 USB
FAVORITE R
S

“Tag” Display

Spectrum Scope Monitor Operation

Note: This operation does not function in the FM Broadcast frequencies.

The Spectrum Scope Monitor allows viewing of operating activity on 5 channels above and 5 channels below the current operating channel in the VFO mode. When the Spectrum Scope Monitor is activated, the display indicates the relative signal strength on channels immediately adjacent to the current operating frequency.



Two basic operating modes for Spectrum Scope are available:

CONT: In this mode, the transceiver sweeps the current band repeatedly until the Spectrum Scope is turned off.

CHK: In this mode, the transceiver sweeps the current band one cycle every 10 seconds.

Setting the Spectrum Scope Mode

1. Press and hold in the **[F]** key for one second to enter the Menu mode
2. Rotate the **[SEL]** knob to select Menu #43 (SCOPE).
3. Rotate the **[DIAL]** knob to select the desired sweep mode (see above).
4. When you have made your selection, press and hold in the **[F]** key for one second to save the new setting and exit to normal operation.

Activate the Spectrum Scope

1. Set the transceiver to the VFO mode in the desired band.
2. Press the **[F]** key momentarily, then rotate the **[SEL]** knob, as needed, until Operating Function Row 6 [SSM, SCH, ART] appears on the display.
3. Press the **[A]** (SSM) key momentarily to engage the Spectrum Scope.
4. When the Spectrum Scope is in operation, the relative signal strength of stations on channels immediately adjacent to the current frequency will be indicated on the display.
5. To disable the Spectrum Scope, press the **[A]** (SSM) key once more.

The receiver's audio output and S-meter are disabled when using the Spectrum Scope.

Smart Search™ Operation

Note: This operation does not function in the FM Broadcast frequencies.

The Smart Search™ feature automatically stores frequencies where activity is encountered on the current band. When Smart Search™ is engaged, the transceiver quickly searches above your current frequency, storing active frequencies as it goes (without stopping on them even momentarily). These frequencies are stored in a special Smart Search™ memory bank, consisting of 50 memories. This feature is available on the FM and AM modes.

The Smart Search™ feature is especially helpful when traveling, as you can instantly store active FM repeater frequencies without having to look up the frequencies in a reference book.

1. Set the **(SQL/RF)** knob to the point where background noise is silenced. A typical setting, for effective Smart Search™ operation, will be at 12 o'clock or slightly clockwise from this position.
2. Set the VFO to the frequency on which you wish to begin the search (the Smart Search™ feature is available on the VFO mode only).
3. Press the **(F)** key momentarily, then rotate the **(SEL)** knob, as needed, until Operating Function Row 6 [SSM, SCH, ART] appears on the display.
4. Now press the **(B)** (SCH) key momentarily; the blinking "SRCH" indicator will appear on the LCD, and the transceiver will sweep upward on the current band, loading channels on which it encounters a signal strong enough to open the squelch.
5. All channels where activity is present (up to 50 channels) will be loaded into the Smart Search™ memories. Whether or not all 50 memories are filled, the search will stop after one sweep.
6. Now you can turn the **(SEL)** knob to select from the just-stored Smart Search™ memories. If you find frequencies you wish to store into a "regular" memory, just follow the procedures described previously; just don't press the **(B)** (SCH) key while storing these memories, because this will disable Smart Search™ operation (see step 7).
7. To disable Smart Search™ operation, press the **(B)** (SCH) key momentarily.

The Smart Search™ memories are so-called "soft" memories; they will be lost if you initiate a new Smart Search™ sweep of the band.

Scanning Operation

Note: This operation does not function in the FM Broadcast frequencies.

This transceiver contains a wide variety of scanning capabilities. Whether you are in the VFO mode or one of the memory modes, scanning operation is fundamentally identical in all configurations, but with the following differences:

- ❑ In the VFO mode, scanning causes the transceiver to sweep up or down the band, pausing or halting on any signal encountered;
- ❑ In the Memory mode, the scanner will scan the programmed memories, and can be instructed to skip certain memories during scanning;
- ❑ In the Programmable Memory Scan (PMS) mode, the scanner will scan the band within user-programmed frequency limits.

Scanning Operation

1. Set the **(SQL/RF)** knob to the point where background noise is silenced. A typical setting, for effective scanning operation, will be at 12 o'clock or slightly clockwise from this position.
2. Set the transceiver into the operating configuration in which you wish to scan (VFO or Memory; PMS will be described later).
3. Press the **(F)** key momentarily, then rotate the **(SEL)** knob, as needed, until Operating Function Row [SCN, PRI, DW].
4. Press the **(A)** (SCN) key momentarily to start upward scan (toward higher frequencies or higher memory channel numbers).
5. Rotate the **(DIAL)** knob or **(SEL)** knob counterclockwise to toggle the scanning direction downward.
6. The scanner will now cause the transceiver to increment in the chosen direction until a signal is detected. When a signal is encountered which opens the Squelch, **In the FM/AM modes**, the scanner will pause until the signal disappears (at the end of the other station's transmission), at which point scanning will resume. While the transceiver is in the "Pause" condition, the decimal points in the frequency display area will blink. See "Scan-Resume Choices" on the next page for details of how to customize the resumption of scanning, **In the SSB/CW modes**, the scanner will slow down (but doesn't stop).
7. Press the **PTT** switch on the microphone to cancel scanning.

You may also press and hold in either the [UP] or [DWN] key on the microphone for 1/2 second to initiate upward or downward scanning, respectively, if Menu #37 (MIC SCAN) is set to "ON".

Scanning Operation

Scan Skip Programming (Memory Mode Only)

Among the memories you have programmed, there may be some stations which you do not wish to scan. For example, broadcast signals (which are transmitted continuously) will cause the scanner to stop, and such channels may be skipped so as to avoid this inconvenience.

To remove a channel from the scanning loop:

1. Press the **F** key momentarily, then rotate the **(SEL)** knob, as needed, until Operating Function Row 2 [MW, MC, TAG] appears on the display.
2. Recall the memory channel to be skipped.
3. Press the **B** (MC) key momentarily. The “hyphen” in the memory channel number will change to become a “dot”; this shows that this channel now is not included in the scanning loop.
4. Repeat steps 2 and 3 as many times as necessary to skip all the channels you do not wish to scan.
5. Initiate memory scanning; you will observe that the channels you marked to be skipped are not included in the scanning loop.
6. Press the **PTT** switch to stop the scan; you may now use the **(SEL)** knob to step through the channels manually - one at a time - and you will observe that the “Skipped” channels are, nonetheless, available for recall by manual means.
7. You may restore a previously-skipped channel to the scanning loop by selecting the channel manually, then pressing the **B** (MC) key momentarily so that the “dot” changes to become a “hyphen”.

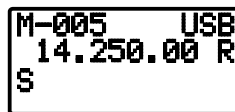

M-005 USB
14.250.00 R
S

Memory Skip “OFF”

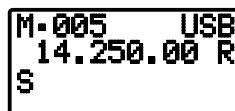

M-005 USB
14.250.00 R
S

Memory Skip “ON”

Scan-Resume Choices

Scanning operation requires that you have the transceiver’s audio squelched. The transceiver then “assumes” that the opening of the squelch corresponds to the discovery of a signal you may wish to listen to.

Once the scan has been halted, the transceiver pauses on the signal and stays locked on its frequency for five seconds (default pause time). Thereafter, scanning will resume whether or not the other station’s transmission has ended. The scan resume interval can be set to 3/5/10 seconds, or off (whereby scanning quits when a signal is received) via Menu #41 (RESUME); see 60 for details.

Programmable Memory Scan (PMS) Operation

To limit scanning (or tuning) within a particular frequency range, you can use the Programmable Memory Scanning (PMS) feature, which utilizes special-purpose memory pair (“M-PL” and “M-PU”). The PMS feature is especially useful in helping you to observe any operating sub-band limits which apply to your Amateur license class.

PMS setup is simple to accomplish;

1. Store the upper and lower frequency limits of the desired range into the PMS memory pair (“M-PL” and “M-PU”).
2. Press the **[F]** key momentarily, then rotate the **[SEL]** knob, as needed, until Operating Function Row 3 [STO, RCL, PMS] appears on the display.
3. Press the **[C]** (PMS) key. The “PMS” indication will appear at the upper left corner of the LCD, signifying that the PMS feature is engaged. Tuning and scanning are now limited within the range between the selected PMS memory pair, keeping operation inside this programmed range.

Example: Limit tuning & scanning to the frequency range 144.300 - 148.000 MHz

1. Press the **[VM]** key, as necessary, to recall the VFO mode. Tune the **[SEL]** knob or **[DIAL]** knob to 144.300 MHz.
2. Press the **[F]** key momentarily, then rotate the **[SEL]** knob, as needed, until Operating Function Row 2 [MW, MC, TAG] appears on the display.
3. Press the **[A]** (MW) key momentarily, then turn the **[SEL]** knob to select memory channel “M-PL”.
4. Press and hold in the **[A]** (MW) key for one second to write the VFO frequency into “M-PL”.
5. Now, tune the **[SEL]** knob or **[DIAL]** knob to 148.000 MHz).
6. Press the **[A]** (MW) key momentarily, then turn the **[SEL]** knob to select memory channel “M-PU”.
7. Press and hold the **[A]** (MW) key for one second to write the VFO frequency into “M-PU”.
8. Press the **[F]** key momentarily, then rotate the **[SEL]** knob one click clockwise to recall Operating Function Row 3 [STO, RCL, PMS].
9. Press the **[C]** (PMS) key momentarily. Tuning and scanning are now limited to the 144.300 ~ 148.000-MHz range until you press the **[VM]** key to return to memory or VFO operation.

Note

The frequency resolution for these sub-band limits is 100 kHz, although the channel resolution of the sub-band limit memories in whatever you have selected as the current step size. As a result, the frequencies stored in these special memories (M-PL and M-PU) are both rounded down to the nearest 100 kHz for their roles as sub-band limits. Therefore, in the above example, any frequency between 144.300 and 144.399 MHz may be used to store a lower tuning limit of “144.300 MHz” in memory M-PL.

Dual Watch Operation

Note: *This operation does not function in the FM Broadcast frequencies.*

Dual Watch is similar, in some respects, to scanning. In Dual Watch, however, the transceiver monitors (squelsched) on the VFO-A frequency while periodically checking VFO-B for activity (or vice-versa). A typical example might be for you to set VFO-A to 50.110 MHz, watching for DX stations who might call CQ on that frequency, while periodically checking 28.885 MHz for stations reporting band openings on 6 meters.

To activate Dual Watch:

1. Set up transmit and receive operation on VFO-A, establishing your primary monitoring frequency. Set up the frequency to be checked periodically on VFO-B.
2. Recall VFO-A, then rotate the **SQL/RF** control until the background noise is just silenced.
3. Press the **F** key momentarily, then rotate the **SEL** knob, as needed, until Operating Function Row 5 [SCN, PRI, DW] appears on the display.
4. Press the **C** (DW) key momentarily to activate Dual Watch operation (the “DW” icon will appear at the bottom left corner of the LCD).
5. The transceiver will continue to monitor (squelsched) on the current (VFO-A) frequency, but every five seconds will switch briefly to VFO-B frequency, looking for activity.
6. If a station is detected on the VFO-B frequency, the transceiver will pause on the VFO-B frequency (the decimal point in the frequency will blink).
7. Press the **C** (DW) key again to cancel Dual Watch operation (the “DW” icon will disappear).

Note that pressing the PTT switch on the microphone does not cancel Dual Watch operation.

Operation on Alaska Emergency Frequency: 5167.5 khz (U.S. Version Only)

Section 97.401(d) of the regulations governing amateur radio in the United States permit emergency amateur communications on the spot frequency of 5167.5 kHz by stations in (or within 92.6 km of) the state of Alaska. This frequency is *only* to be used when the *immediate safety of human life and/or property* are threatened, and is *never* to be used for routine communications.

The **FT-818** includes the capability for transmission and reception on 5167.5 kHz under such emergency conditions via the Menu system. To activate this feature:

1. Press and hold in the **[F]** key for one second to activate the Menu mode.
2. Rotate the **[SEL]** knob to select Menu #28 (EMERGENCY).
3. Rotate the **[DIAL]** knob to select "ON".
4. Press and hold in the **[F]** key to exit the Menu mode.

Emergency communication on this spot frequency is now possible:

Press the **[V/M]** key, as necessary, to enter the Memory mode, then rotate the **[SEL]** knob to select the emergency channel (M-EMG), which is found between channels M-PU and M-001.

Note that the receive-mode Clarifier functions normally while using this frequency, but variation of the transmit frequency is not possible. Activation of Menu #28 does not enable any other out-of-amateur-band capability on the transceiver. The full specifications of the **FT-818** are not necessarily guaranteed on this frequency, but power output and receiver sensitivity should be fully satisfactory for the purpose of emergency communication.

If you wish to disable operation on the Alaska Emergency Frequency, repeat the procedure detailed above, but set Menu #28 to "OFF" in step 3 of the procedure.

In an emergency, note that a half-wave dipole cut for this frequency should be approximately 45'3" on each leg (90'6" total length).

Emergency operation on 5167.5 kHz is shared with the Alaska-Fixed Service. This transceiver is not authorized for operation, under the FCC's Part 87, for aeronautical communications.

Menu Operation

The Menu System allows you to customize a wide variety of transceiver performance aspects and operating characteristics. Once you have gone through the various Menu customization procedures initially, you will find that you will not have to resort to them frequently during everyday operation.

Menu Operation

1. Press and hold in the **[F]** key for one second. The Menu Item number and a brief title for the Menu Item will appear in the display.
2. Rotate the **[SEL]** knob to select the Menu Item you wish to work on.
3. When you have chosen the desired Menu Item number, rotate the **[DIAL]** knob to change the value or condition for the Menu Item.
4. When you have made your selection, press and hold in the **[F]** key for one second to save the new setting and exit to the normal operation.

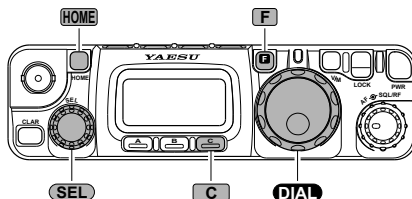

- **In step (3) above, if you press the **[HOME]** key momentarily, it will reset the setting of that Menu Item to its factory-default value.**
- **In step (4) above, if you press the **[C]** key momentarily, you will exit to normal operation without saving the new setting.**

| Menu Item | Function | Available Values | Default |
|--------------|---|--|----------|
| 01 144 ARS | Activate/deactivate the Automatic Repeater Shift when operating on the 144 MHz band | OFF/ON | ×1 |
| 02 430 ARS | Activate/deactivate the Automatic Repeater Shift when operating on the 430 MHz band | OFF/ON | ×1 |
| 03 9600 MIC | Adjust the audio input level from the TNC during 9600 bps Packet operation | 0 ~ 100 | 50 |
| 04 AM&FM DL | Enabling/disabling the [DIAL] knob on the AM and FM modes | ENABLE/DISABLE | DISABLE |
| 05 AM MIC | Adjust the microphone gain level for the AM mode | 0 ~ 100 | 50 |
| 06 AM STEP | Select the tuning steps for the [SEL] knob on the AM mode | 2.5/5/9/10/12.5/25kHz | ×1 |
| 07 ANTENNA | Select the antenna connector to be used on each operating band (HF/50/144/430 MHz) | FRONT/REAR | ×1 |
| 08 APO TIME | Select the Auto Power Off time (time before power goes off) | OFF/1h ~ 6h | OFF |
| 09 ARTS BEEP | Select the ARTS beep mode | OFF/RANGE/ALL | RANGE |
| 10 BACKLIGHT | Select the LCD lamp mode | OFF/ON/AUTO | AUTO |
| 11 BATT-CHG | Select the battery charging time | 6/8/10 h (hours) | 10 |
| 12 BEEP FREQ | Select the beep frequency | 440/880 Hz | 880 Hz |
| 13 BEEP VOL | Select the beep volume | 0 ~ 100 | 50 |
| 14 CAT RATE | Set the transceiver's circuitry for the CAT baud rate | 4800/9600/38400 bps | 4800 bps |
| 15 COLOR | Select the illumination color for the LCD illumination | COLOR1 (Blue)/ COLOR2 (Amber)/ COLOR3 (Violet) | COLOR1 |
| 16 CONTRAST | Setting of the display contrast level | 1 ~ 12 | 5 |
| 17 CW DELAY | Set the receiver recovery time during pseudo-VOX CW semi-break-in operation | 10 ~ 500 msec | 250 msec |
| 18 CW ID | Enables/disables the CW identifier during ARTS operation | OFF/ON | OFF |
| 19 CW PADDLE | Select the keyer paddle's wiring configuration | NORMAL/REVERSE | NORMAL |

Menu Operation

| Menu Item | Function | Available Values | Default | |
|-----------|-----------|---|--|--------------------|
| 20 | CW PITCH | Setting of the pitch of the CW sidetone, BFO offset, and CW filter center frequencies | 300 ~ 1000 Hz | 700 Hz |
| 21 | CW SPEED | Set the sending speed for the built-in Electronic keyer | 4 wpm ~ 60 wpm/ 20 cpm ~ 300 cpm | 12 wpm (60 cpm) |
| 22 | CW WEIGHT | Set the Dot:Dash ratio for the built-in electronic keyer | 1:2.5 ~ 1:4.5 | 1:3.0 |
| 23 | DCS CODE | Setting the DCS code | 104 Std DCS codes | 023 |
| 24 | DIG DISP | Define the displayed frequency offset during DIG (USER-L or USER-U) mode operation | -3000 ~ +3000 Hz | 0 Hz |
| 25 | DIG MIC | Adjust the audio input level from terminal equipment (such as a TNC or PSK-31 sound card) during DIG (Digital) mode operation | 0 ~ 100 | 50 |
| 26 | DIG MODE | Select the mode and sideband (if applicable) in the DIG (Digital) mode | RTTY/ PSK31-L/PSK31-U/ USER-L/USER-U | RTTY |
| 27 | DIG SHIFT | Define the carrier frequency offset during DIG (USER-L or USER-U) mode operation | -3000 ~ +3000 Hz | 0 Hz |
| 28 | EMERGENCY | Enable Tx/Rx operation on the Alaska Emergency Channel, 5167.5 kHz (USA Version only) | OFF/ON | OFF |
| 29 | FM MIC | Adjust the microphone gain level for the FM mode | 0 ~ 100 | 50 |
| 30 | FM STEP | Select the tuning steps for the [SEL] knob on the FM mode | 5/6.25/10/12.5/15/ 20/25/50 kHz | ※2 |
| 31 | ID | Store your callsign into the CW identifier | - | YAESU |
| 32 | LOCK MODE | Select the operation of the front panel's [LOCK] key | DIAL/FREQ/PANEL | DIAL |
| 33 | MAIN STEP | Setting of the [DIAL] 's tuning speed | FINE/COARSE | FINE |
| 34 | MEM GROUP | Enable/disable the memory grouping feature | OFF/ON | OFF |
| 35 | MEM TAG | Store Alpha-Numeric "Tags" for the memory channels | - | - |
| 36 | MIC KEY | Enable/disable CW keying by the microphone's [UP]/[DWN] keys | OFF/ON | OFF |
| 37 | MIC SCAN | Enable/disable scanning access | OFF/ON | ON |
| 38 | OP FILTER | Enable the optional filter (CW or SSB) | OFF/SSB/CW | OFF |
| 39 | PKT MIC | Adjust the audio input level from the TNC during 1200 bps Packet operation | 0 ~ 100 | 50 |
| 40 | PKT RATE | Set the transceiver's circuitry for the Packet baud rate | 1200/9600 bps | 1200 bps |
| 41 | RESUME | Set the delay time for scanning resumption | OFF/3/5/10 seconds | 5 sec |
| 42 | RPT SHIFT | Set the magnitude of the Repeater Shift | 0 ~ 99.99 MHz | ※2 |
| 43 | SCOPE | Select the Spectrum Scope mode | CONT/CHK | CONT |
| 44 | SIDETONE | Adjust the CW sidetone volume level | 0 ~ 100 | 50 |
| 45 | SQL/RF-G | Select the configuration of the front panel's [SQL/RF] knob | RF-GAIN/SQL | ※1 |
| 46 | SSB MIC | Adjust the microphone gain level for the SSB mode | 0 ~ 100 | 50 |
| 47 | SSB STEP | Select the tuning steps for the [SEL] knob on the SSB mode | 1/2.5/5 kHz | 2.5 kHz |
| 48 | TONE FREQ | Setting the CTCSS Tone Frequency | 50 Std CTCSS tones | 88.5 Hz |
| 49 | TOT TIME | Select the Time-Out-Timer time | OFF/1 ~ 20 min | OFF |
| 50 | VOX DELAY | Set the "hang time" for the VOX circuitry | 100 ~ 2500 msec | 500 msec |
| 51 | VOX GAIN | Set the gain of the VOX circuitry's input audio detector | 1 ~ 100 | 50 |
| 52 | EXTEND | Enable/disable the extended Menu Items (#53 ~ #57) | OFF/ON | OFF |
| 53 | DCS INV | Select "Normal" or "Inverted" DCS coding | Tn-Rn/Tn-Riv/ Tiv-Rn/Tiv-Riv | Tn-Rn |
| 54 | R LSB CAR | Set the Rx Carrier Point for LSB | -300 ~ +300 Hz | 0 Hz |
| 55 | R USB CAR | Set the Rx Carrier Point for USB | -300 ~ +300 Hz | 0 Hz |
| 56 | T LSB CAR | Set the Tx Carrier Point for LSB | -300 ~ +300 Hz | 0 Hz |
| 57 | T USB CAR | Set the Tx Carrier Point for USB | -300 ~ +300 Hz | 0 Hz |

※1: Depends on transceiver version.

※2: Depends on operating band and transceiver version.

Menu Operation

Menu Item 01 [144 ARS]

Function: Activate/deactivate the Automatic Repeater Shift when operating on the 144 MHz band.

Available Values: OFF/ON

Default: ON (depending on transceiver version)

Menu Item 02 [430 ARS]

Function: Activate/deactivate the Automatic Repeater Shift when operating on the 430 MHz band.

Available Values: OFF/ON

Default: ON (depending on transceiver version)

Menu Item 03 [9600 MIC]

Function: Adjust the audio input level from the TNC during 9600 bps Packet operation.

Available Values: 0 ~ 100

Default: 50

Menu Item 04 [AM&FM DL]

Function: Enabling/disabling the **DIAL** knob on the AM and FM modes.

Available Values: ENABLE/DISABLE

Default: DISABLE

Menu Item 05 [AM MIC]

Function: Adjust the microphone gain level for the AM mode.

Available Values: 0 ~ 100

Default: 50

Menu Item 06 [AM STEP]

Function: Select the tuning steps for the **SEL** knob on the AM mode.

Available Values: 2.5/5/9/10/12.5/25kHz

Default: 5 kHz (depending on transceiver version)

Menu Item 07 [ANTENNA]

Function: Select the antenna connector to be used on each operating band (HF/50/144/430 MHz).

Available Values: FRONT/REAR

Default: HF: REAR, 50/144/430 MHz: FRONT

When select the REAR antenna connector, the "R" icon will appear on the display

Menu Item 08 [APO TIME]

Function: Select the Auto Power Off time (time before power goes off).

Available Values: OFF/1h ~ 6h

Default: OFF

Menu Item 09 [ARTS BEEP]

Function: Select the ARTS beep mode.

Available Values: OFF/RANGE/ALL

Default: RANGE

OFF: No alert beeps sound; you must look at the display to determine current ARTS status.

RANGE: A high tone beep will sound when the transceiver first detects that you are within range, and a low beep will sound when the other station goes out of range.

ALL: A high tone beep will sound every time a polling transmission is received from the other station, and a low beep will sound *once* when the other station goes out of range.

Menu Item 10 [BACKLIGHT]

Function: Select the LCD lamp mode.

Available Values: OFF/ON/AUTO

Default: AUTO

OFF: Disables the LCD lamp.

ON: Illuminates the LCD lamp continuously.

AUTO: Illuminates the LCD lamp for five seconds when any key is pressed.

Menu Item 11 [BATT-CHG]

Function: Select the battery charging time.

Available Values: 6/8/10 h (hours)

Default: 10 h

Menu Item 12 [BEEP FREQ]

Function: Select the beep frequency

Available Values: 440/880 Hz

Default: 880 Hz

Menu Item 13 [BEEP VOL]

Function: Select the beep volume

Available Values: 0 ~ 100

Default: 50

Menu Item 14 [CAT RATE]

Function: Set the transceiver's circuitry for the CAT baud rate to be used.

Available Values: 4800/9600/38400 bps

Default: 4800 bps

Menu Item 15 [COLOR]

Function: Select the illumination color for the LCD illumination.

Available Values: COLOR1 (Blue)/COLOR2 (Amber)/COLOR3 (Violet)

Default: COLOR1(Blue)

Menu Operation

Menu Item 16 [CONTRAST]

Function: Setting of the display contrast level.

Available Values: 1 ~ 12

Default: 5

Menu Item 17 [CW DELAY]

Function: Set the receiver recovery time during pseudo-VOX CW semi-break-in operation.

Available Values: 10 ~ 500 msec

Default: 250 msec

The recovery time may be adjusted in steps of 10 msec. A longer delay may be preferable if you pause frequently while sending.

Menu Item 18 [CW ID]

Function: Enables/disables the CW identifier during ARTS operation.

Available Values: OFF/ON

Default: OFF

Menu Item 19 [CW PADDLE]

Function: Select the keyer paddle's wiring configuration.

Available Values: NORMAL/REVERSE

Default: NORMAL

NORMAL: Keyer paddle polarity is normal. The "tip" plug connection produces dots, and the "ring" plug connection produces dashes.

REVERSE: Keyer paddle polarity is inverted. The "tip" paddle produces dashes, and the "ring" paddle produces dots.

Menu Item 20 [CW PITCH]

Function: Setting of the pitch of the CW sidetone, BFO offset, and CW filter center frequencies.

Available Values: 300 ~ 1000 Hz

Default: 700 Hz

The CW pitch may be adjusted in steps of 50 Hz.

Menu Item 21 [CW SPEED]

Function: Set the sending speed for the built-in Electronic keyer.

Available Values: 4wpm ~ 60 wpm/20cpm ~ 300 cpm

Default: 12 wpm (60 cpm)

You can set the sending speed according to either of two units of speed (wpm: words per minute; cpm: characters per minute). To switch units between "wpm" and "cpm," just press the **(SEL)** knob.

Menu Item 22 [CW WEIGHT]

Function: Set the Dot:Dash ratio for the built-in electronic keyer.

Available Values: 1:2.5 ~ 1:4.5

Default: 1:3.0

Menu Item 23 [DCS CODE]

Function: Setting the DCS code.

Available Values: 104 Standard DCS codes

Default: 023

| DCS Code | | | | | | | | | | | | | | |
|----------|-----|-----|-----|-----|-----|-----|-----|-----|-----|-----|-----|-----|-----|-----|
| 023 | 025 | 026 | 031 | 032 | 036 | 043 | 047 | 051 | 053 | 054 | 065 | 071 | 072 | 073 |
| 074 | 114 | 115 | 116 | 122 | 125 | 131 | 132 | 134 | 143 | 145 | 152 | 155 | 156 | 162 |
| 165 | 172 | 174 | 205 | 212 | 223 | 225 | 226 | 243 | 244 | 245 | 246 | 251 | 252 | 255 |
| 261 | 263 | 265 | 266 | 271 | 274 | 306 | 311 | 315 | 325 | 331 | 332 | 343 | 346 | 351 |
| 356 | 364 | 365 | 371 | 411 | 412 | 413 | 423 | 431 | 432 | 445 | 446 | 452 | 454 | 455 |
| 462 | 464 | 465 | 466 | 503 | 506 | 516 | 523 | 526 | 532 | 546 | 565 | 606 | 612 | 624 |
| 627 | 631 | 632 | 654 | 662 | 664 | 703 | 712 | 723 | 731 | 732 | 734 | 743 | 754 | - |

Menu Item 24 [DIG DISP]

Function: Define the displayed frequency offset during DIG (USER-L or USER-U) mode operation.

Available Values: -3000 ~ +3000 Hz

Default: 0 Hz

Menu Item 25 [DIG MIC]

Function: Adjust the audio input level from terminal equipment (such as a TNC or PSK-31 sound card) during DIG (Digital) mode operation.

Available Values: 0 ~ 100

Default: 50

Menu Item 26 [DIG MODE]

Function: Select the mode and sideband (if applicable) in the DIG (Digital) mode.

Available Values: RTTY/PSK31-L/PSK31-U/USER-L/USER-U

Default: RTTY

RTTY: AFSK RTTY operation on the LSB mode

PSK31-L: PSK-31 operation on the LSB mode

PSK31-U: PSK-31 operation on the USB mode

USER-L: User-programmed costume operation based on LSB mode

USER-U: User-programmed costume operation based on USB mode

In the USER-L and USER-U modes, you can define the display frequency offset and carrier frequency offset by menu items #24 (DIG DISP) and #27 (DIG SHIFT).

Menu Operation

Menu Item 27 [DIG SHIFT]

Function: Define the carrier frequency offset during DIG (USER-L or USER-U) mode operation.

Available Values: -3000 ~ +3000 Hz

Default: 0 Hz

Menu Item 28 [EMERGENCY]: USA Version only

Function: Enable Tx/Rx operation on the Alaska Emergency Channel, 5167.5 kHz.

Available Values: OFF/ON

Default: OFF

When this Menu Item is set to “ON,” the spot frequency of 5167.5 kHz will be enabled. To get to this frequency, use the **(SEL)** knob to navigate; the Alaska Emergency Channel will be found between the Memory channel “M-PU” and “M-001”.

Use of this frequency is restricted to amateurs operating in (or within 92.6 km of) the U.S. State of Alaska, and it is to be used for emergency communications only (involving the immediate protection of life or property).

Menu Item 29 [FM MIC]

Function: Adjust the microphone gain level for the FM mode.

Available Values: 0 ~ 100

Default: 50

Menu Item 30 [FM STEP]

Function: Select the tuning steps for the **(SEL)** knob on the FM mode.

Available Values: 5/6.25/10/12.5/15/20/25/50 kHz

Default: 5 kHz (depends on operating band and transceiver version)

Menu Item 31 [ID]

Function: Store your callsign into the CW identifier. Up to eight characters may be stored. The storage procedure is as follows:

1. Press the **(SEL)** knob momentarily to initiate callsign storage (an “under-bar” will appear below the first character location of the callsign).
2. Rotate the **(DIAL)** knob to select the first letter/number of your callsign, then rotate the **(SEL)** knob one click clockwise to save the first letter/number and move to the next entry position.
3. Repeat the previous step as many times as necessary to complete your callsign.
4. Press the **(SEL)** knob to save your completed callsign and exit.

Default: YAESU

Menu Item 32 [LOCK MODE]

Function: Select the operation of the front panel's **[LOCK]** key.

Available Values: DIAL/FREQ/PANEL

Default: DIAL

DIAL: Locks **[DIAL]** knob only

FREQ: Locks front panel keys and knobs related to frequency control (such as **[BAND(DWN)]** and **[BAND(UP)]** key, **[A]** (A/B) key., etc.)

PANEL: Locks all front keys and knobs (except **[PWR]** key and **[LOCK]** key)

Menu Item 33 [MAIN STEP]

Function: Setting of the **[DIAL]** knob's tuning speed.

Available Values: FINE/COARSE

Default: FINE

You may choose between two speeds for the **[DIAL]** knob. Selecting "COARSE" doubles the tuning rate compared to the default value.

Menu Item 34 [MEM GROUP]

Function: Enable/disable the memory grouping feature

Available Values: OFF/ON

Default: OFF

When this Menu Item is set to "ON," the 200 "standard" memory channels are partitioned into ten Memory Groups, each holding up to 20 memory channels.

Menu Item 35 [MEM TAG]

Function: Store Alpha-Numeric "Tags" for the memory channels.

Up to eight characters may be stored. The storage procedure is as follows:

1. Recall the memory channel on which you wish to append a label.
2. Recall this Menu Item [Menu #35 (MEM TAG)].
3. Press the **[SEL]** knob momentarily to initiate storing of the Tag (an under-bar will appear below the first character location).
4. Rotate the **[DIAL]** knob to select the first character (number, letter, or symbol) in the name you wish to store, then rotate the **[SEL]** knob clockwise to move to the next character.
5. Again rotate the **[DIAL]** knob to select the next number, letter, or symbol, then rotate the **[SEL]** knob clockwise to move to the next character's slot.
6. Repeat step 5 as many times as necessary to complete the name tag for the memory.
7. Press the **[SEL]** knob to save the A/N (Alpha-Numeric) Tag and exit.

Menu Item 36 [MIC KEY]

Function: Enable/disable CW keying by the microphone's **[UP]/[DWN]** keys.

Available Values: OFF/ON

Default: OFF

When this Menu Item is set to "ON," press the microphone's **[UP]** key to send a "dot," and press the microphone's **[DWN]** key to send a "dash" (while the built-in electronic keyer is engaged).

Menu Operation

Menu Item 37 [MIC SCAN]

Function: Enable/disable scanning access via the microphone's [UP]/[DWN] keys.

Available Values: OFF/ON

Default: ON

Menu Item 38 [OP FILTER]

Function: Enable the optional filter (CW or SSB) path.

Available Values: OFF/SSB/CW

Default: OFF

After installing the optional filter, set this Menu Item to define the signal path corresponding to the filter you have installed.

Menu Item 39 [PKT MIC]

Function: Adjust the audio input level from the TNC during 1200 bps Packet operation.

Available Values: 0 ~ 100

Default: 50

Menu Item 40 [PKT RATE]

Function: Set the transceiver's circuitry for the Packet baud rate to be used.

Available Values: 1200/9600 bps

Default: 1200 bps

Menu Item 41 [RESUME]

Function: Set the delay time for scanning resumption.

Available Values: OFF/3/5/10 seconds

Default: 5 sec

When this Menu Item set to "OFF," the scanner stops (without restarting) until you press the **[A]** (SCN) key (or the microphone's [UP]/[DWN] keys).

Menu Item 42 [RPT SHIFT]

Function: Set the magnitude of the Repeater Shift.

Available Values: 0 ~ 99.99 MHz

Default: Depends on transceiver version, and the band in use.

Each band's repeater shift (HF/50/144/430 MHz) may be set independently.

Menu Item 43 [SCOPE]

Function: Select the Spectrum Scope mode.

Available Values: CONT/CHK

Default: CONT

CONT: The Spectrum Scope sweeps continuously.

CHK: The Spectrum Scope sweeps one cycle every 10 seconds.

Menu Item 44 [SIDETONE]

Function: Adjust the CW sidetone volume level.

Available Values: 0 ~ 100

Default: 50

Menu Item 45 [SQL/RF-G]

Function: Select the configuration of the front panel's (SQL/RF) knob.

Available Values: RF-GAIN/SQL

Default: Depends on transceiver version

Menu Item 46 [SSB MIC]

Function: Adjust the microphone gain level for the SSB mode.

Available Values: 0 ~ 100

Default: 50

Menu Item 47 [SSB STEP]

Function: Select the tuning steps for the (SEL) knob on the SSB mode.

Available Values: 1/2.5/5 kHz

Default: 2.5 kHz

Menu Item 48 [TONE FREQ]

Function: Setting the CTCSS Tone Frequency.

Available Values: 50 Standard CTCSS tones

Default: 88.5 Hz

| CTCSS Tone Frequency (Hz) | | | | | | | | | | | | |
|---------------------------|-------|-------|-------|-------|-------|-------|-------|-------|-------|-------|-------|-------|
| 67.0 | 69.3 | 71.9 | 74.4 | 77.0 | 79.7 | 82.5 | 85.4 | 88.5 | 91.5 | 94.8 | 97.4 | 100.0 |
| 103.5 | 107.2 | 110.9 | 114.8 | 118.8 | 123.0 | 127.3 | 131.8 | 136.5 | 141.3 | 146.2 | 151.4 | 156.7 |
| 159.8 | 162.2 | 165.5 | 167.9 | 171.3 | 173.8 | 177.3 | 179.9 | 183.5 | 186.2 | 189.9 | 192.8 | 196.6 |
| 199.5 | 203.5 | 206.5 | 210.7 | 218.1 | 225.7 | 229.1 | 233.6 | 241.8 | 250.3 | 254.1 | - | - |

Menu Item 49 [TOT TIME]

Function: Select the Time-Out-Timer time.

Available Values: OFF/1 ~ 20 min

Default: OFF

Menu Item 50 [VOX DELAY]

Function: Set the "hang time" for the VOX circuitry.

Available Values: 100 ~ 2500 msec

Default: 500 msec

Menu Item 51 [VOX GAIN]

Function: Set the gain of the VOX circuitry's input audio detector.

Available Values: 1 ~ 100

Default: 50

Menu Item 52 [EXTEND]

Function: Enable/disable the extended Menu Items (#53 ~ #57).

Available Values: OFF/ON

Default: OFF

Menu Operation

Menu Item 53 [DCS INV]

Function: Select “Normal” or “Inverted” DCS coding.

Available Values: Tn-Rn/Tn-Riv/Tiv-Rn/Tiv-Riv

Default: Tn-Rn

“n” = “normal

“iv” = “inverted”

Menu Item 54 [R LSB CAR]

Function: Set the Rx Carrier Point for LSB

Available Values: –300 ~ +300 Hz

Default: 0 Hz

Menu Item 55 [R USB CAR]

Function: Set the Rx Carrier Point for USB

Available Values: –300 ~ +300 Hz

Default: 0 Hz

Menu Item 56 [T LSB CAR]

Function: Set the Tx Carrier Point for LSB

Available Values: –300 ~ +300 Hz

Default: 0 Hz

Menu Item 57 [T USB CAR]

Function: Set the Tx Carrier Point for USB

Available Values: –300 ~ +300 Hz

Default: 0 Hz

You can transfer all data stored in one transceiver to another set by utilizing the handy “Cloning” feature. This requires a user-constructed cloning cable which connects the ACC jacks on the two transceivers as shown below.

To clone from one transceiver to another, use the following procedure:

1. Insert the Clone Cable into the ACC jack of each transceiver.
2. Turn both transceivers off, then press and hold in the **MODE** (◀) and **MODE** (▶) keys on each radio while turning the power on again. The “CLONE MODE” notation will appear on the display.
3. On the “destination” radio, press the **C** key.
4. Now, on the “source” radio, press the **A** key. Data will now be transferred to the “Destination” radio from the “Source” radio.
5. If there is a problem during the cloning process, “Error” will be displayed. Check your cable connections and try again.
6. If cloning is successful, turn the “destination” radio off. Now turn the “source” radio off.

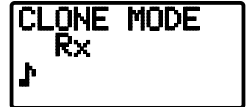

Distination radio



Source radio

Remove the clone cable. Channel and operating data for both radios are now identical. They both may be turned on now for normal operation.

When the radio is “Large Character” mode, the radio does not display the “CLONE MODE” which indicates the “clone mode”. However, the clone operation is the same method.

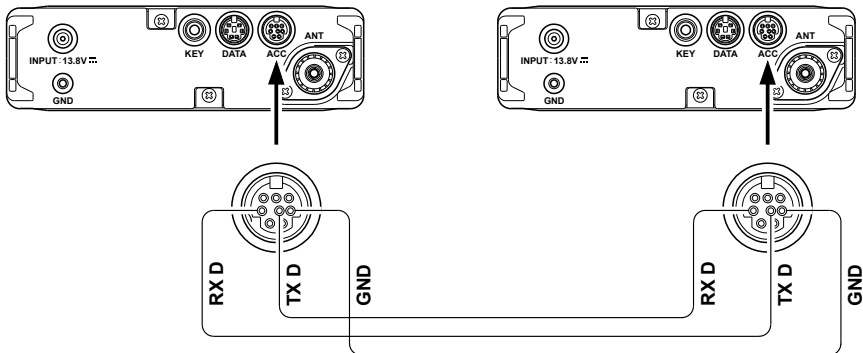

CAT System Programming

The **FT-818**'s CAT System allows the transceiver to be controlled by a personal computer. This allows multiple control operations to be fully automated as a single mouse click, or it allows a third-party software package (such as contest logging software) to communicate with the **FT-818** without (redundant) operator intervention.

The Optional USB Interface Unit SCU-17 may be used for CAT control of the transceiver with a computer via a USB connection.

The Optional CAT Interface Cable CT-62 is a connection cable for the **FT-818** and your computer. The CT-62 has a built-in level converter, allowing direct connection from the rear panel ACC jack to the serial port of your computer, without the need for an external RS-232C level converter box.

Yaesu Musen does not produce CAT System operating software, due to the wide variety of personal computers, operating systems, and applications in use today. However, the **FT-818** (and other Yaesu products) are widely supported by third-party software packages, and we recommend that you contact your dealer for advice, or check advertisements in amateur radio journals. Most software vendors also have Home Pages on the World Wide Web which contain a wealth of information on the features and radio support for their software packages.

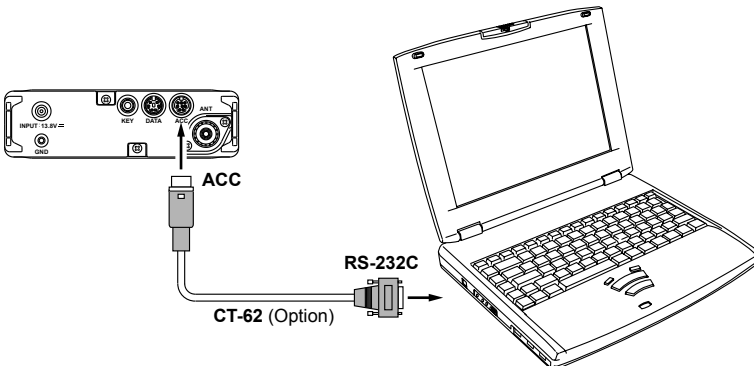
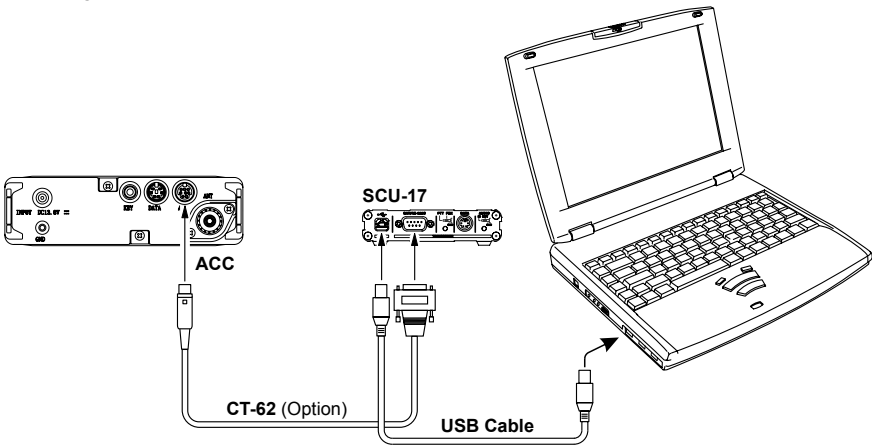

CAT System Programming

CAT Data Protocol

All commands sent from the computer to the transceiver consist of five-byte blocks, with up to 200 ms between each byte. The last byte in each block is the instruction opcode, while the first four bytes of each block are arguments (either parameters for that instruction, or dummy values required to pad the block out to five bytes). Each byte consists of 1 start bit, 8 data bits, no parity bit, and two stop bits.

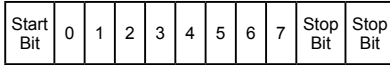

◀ CAT DATA BYTE FORMAT

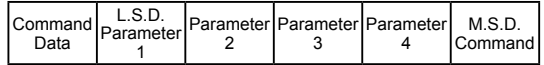

◀ CAT 5-BYTE COMMAND STRUCTURE

There are 17 instruction opcodes for the **FT-818**, listed in the chart on next page. Many of these opcodes are On/Off toggle commands for the same action (e.g. "PTT On" and "PTT Off"). Most of these commands require some parameter or parameters to be set. Irrespective of the number of parameters present, every Command Block sent must consist of five bytes.

Accordingly, any CAT control program must construct the five-byte block by selecting the appropriate instruction opcode, organizing the parameters as needed, and providing unused "dummy" argument bytes to pad the block to its required five-byte length (the dummy bytes can contain any value). The resulting five bytes are then sent, opcode last, from the computer to the **FT-818** CPU via the computer's serial port and the transceiver's ACC jack.

All CAT data values are hexadecimal.

Constructing and Sending CAT Commands

Example #1: Set the VFO frequency to 439.70 MHz

Per the CAT command table, the opcode for "Set Frequency" is 01. Placing the opcode into the 5th data bit position, we then enter the frequency into the first four data bit positions:

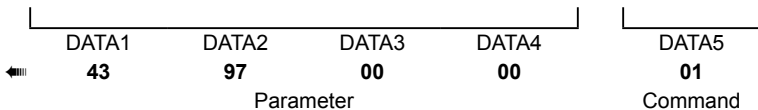

Send these five bytes to the transceiver, in the order shown above.

Example #2: Turn the Split Mode "On"

Per the CAT command table, the opcode for "Split On/off" is 02. Placing the opcode into the 5th data bit position, we then enter dummy values into all other parameter locations:

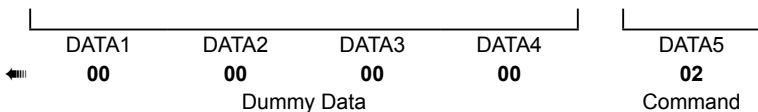

CAT System Programming

Opcode Command Chart

| Command Title | Parameter | | | | Opcode | Notes |
|------------------------------|-----------|----|----|----|------------|--|
| LOCK ON/OFF | ※ | ※ | ※ | ※ | CMD | CMD = 00: LOCK ON CMD = 80: LOCK OFF |
| PTT ON/OFF | ※ | ※ | ※ | ※ | CMD | CMD = 08: PTT ON CMD = 88: PTT OFF |
| Set Frequency | P1 | P2 | P3 | P4 | 01 | P1 ~ P4: Frequency Digits P1 P2 P3 P4 ↓ ↓ ↓ ↓ 01 42 34 56 = 14.23456 MHz |
| Operating Mode | P1 | ※ | ※ | ※ | 07 | P1 = 00: LSB, P1 = 01: USB, P1 = 02: CW, P1 = 03: CWR, P1 = 04: AM, P1 = 08: FM, P1 = 0A: DIG, P1 = 0C: PKT |
| CLAR ON/OFF | ※ | ※ | ※ | ※ | CMD | CMD = 05: CLAR ON CMD = 85: CLAR OFF |
| CLAR Frequency | P1 | ※ | P3 | P4 | F5 | P1 = 00: "+" OFFSET P1 ≠ 00: "-" OFFSET P3, P4: CLAR Frequency P3 P4 ↓ ↓ 12 34 = 12.34 kHz |
| VFO-A/B | ※ | ※ | ※ | ※ | 81 | Toggle |
| SPLIT ON/OFF | ※ | ※ | ※ | ※ | CMD | CMD = 02: SPLIT ON CMD = 82: SPLIT OFF |
| Repeater Offset | P1 | ※ | ※ | ※ | 09 | P1 = 09: "-" SHIFT P1 = 49: "+" SHIFT P1 = 89: SIMPLEX |
| Repeater Offset | P1 | P2 | P3 | P4 | F9 | P1 ~ P4: Frequency Digits 05, 43, 21, 00 = 5.4321 MHz |
| CTCSS/DCS Mode | P1 | ※ | ※ | ※ | 0A | P1 = 0A: DCS ON P1 = 2A: CTCSS ON P1 = 4A: ENCODER ON P1 = 8A: OFF |
| CTCSS Tone | P1 | P2 | ※ | ※ | 0B | P1 ~ P2: CTCSS Tone Frequency P1 P2 (Note 1) ↓ ↓ 08 85 = 88.5 Hz |
| DCS Code | P1 | P2 | ※ | ※ | 0C | P1 ~ P2: DCS Code (Note 2) P1 P2 ↓ ↓ 00 23 = 023 |
| Read RX Status | ※ | ※ | ※ | ※ | E7 | (Note 3) |
| Read TX Status | ※ | ※ | ※ | ※ | F7 | (Note 4) |
| Read Frequency & Mode Status | ※ | ※ | ※ | ※ | 03 | (Note 5) |
| POWER ON/OFF | ※ | ※ | ※ | ※ | CMD | CMD = 0F: POWER ON (Note 6) CMD = 8F: POWER OFF |

CAT System Programming

Note 1: CTCSS Tone

| CTCSS Tone Frequency (Hz) | | | | | |
|---------------------------|-------|-------|-------|-------|-------|
| 67.0 | 69.3 | 71.9 | 74.4 | 77.0 | 79.7 |
| 82.5 | 85.4 | 88.5 | 91.5 | 94.8 | 97.4 |
| 100.0 | 103.5 | 107.2 | 110.9 | 114.8 | 118.8 |
| 123.0 | 127.3 | 131.8 | 136.5 | 141.3 | 146.2 |
| 151.4 | 156.7 | 159.8 | 162.2 | 165.5 | 167.9 |
| 171.3 | 173.8 | 177.3 | 179.9 | 183.5 | 186.2 |
| 189.9 | 192.8 | 196.6 | 199.5 | 203.5 | 206.5 |
| 210.7 | 218.1 | 225.7 | 229.1 | 233.6 | 241.8 |
| 250.3 | 254.1 | - | - | - | - |

P1, P2: CTCSS Tone Frequency

P1 P2

↓ ↓
08 85 = 88.5 Hz

Note 2: DCS Code

| DCS Code | | | | | | |
|----------|-----|-----|-----|-----|-----|-----|
| 023 | 025 | 026 | 031 | 032 | 036 | 043 |
| 047 | 051 | 053 | 054 | 065 | 071 | 072 |
| 073 | 074 | 114 | 115 | 116 | 122 | 125 |
| 131 | 132 | 134 | 143 | 145 | 152 | 155 |
| 156 | 162 | 165 | 172 | 174 | 205 | 212 |
| 223 | 225 | 226 | 243 | 244 | 245 | 246 |
| 251 | 252 | 255 | 261 | 263 | 265 | 266 |
| 271 | 274 | 306 | 311 | 315 | 325 | 331 |
| 332 | 343 | 346 | 351 | 356 | 364 | 365 |
| 371 | 411 | 412 | 413 | 423 | 431 | 432 |
| 445 | 446 | 452 | 454 | 455 | 462 | 464 |
| 465 | 466 | 503 | 506 | 516 | 523 | 526 |
| 532 | 546 | 565 | 606 | 612 | 624 | 627 |
| 631 | 632 | 654 | 662 | 664 | 703 | 712 |
| 723 | 731 | 732 | 734 | 743 | 754 | - |

P1, P2: DCS Code

P1 P2

↓ ↓
00 23 = 023

Note 3: Read RX Status

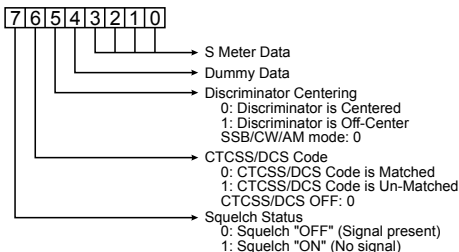

Note 4: Read TX Status

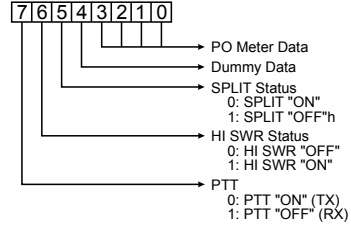

Note 5: Read Frequency & Mode Status

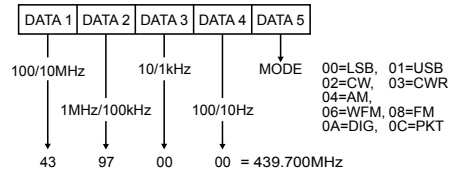

Note 6: POWER ON/OFF

- Do not use this command when using Alkaline batteries or the supplied SBR-32MH Ni-MH battery Pack.
- Send a 5-byte dummy data (such as "00, 00, 00,00, 00") first, when send this command.

Installation of Optional Accessories

Optional Filters YF-122S/YF-122C/YF-122CN

1. Turn the transceiver's power off by pressing and holding in the **PWR** switch for 1/2 second, then remove the **FBA-28** Battery Case or **SBR-32MH** Ni-MH Battery Pack from the transceiver. Additionally, disconnect the DC cable from the **INPUT: 13.8V** jack on the rear panel of the transceiver, when operating the **FT-818** with a DC power supply.
2. Referring to Figure 1, remove the shoulder belt bracket and its two screws from both side of the transceiver, then remove the five screws affixing the top case of the transceiver, and remove the top case; disconnect the speaker's connector when you remove the top case.
3. Refer to Figure 2 for the mounting locations for the optional filters. Position the filter so that its connectors are aligned with the mounting pins on the board, and push it into place.
4. Replace the top case (remember to replace the internal speaker's plug), and connect the **FBA-28** Battery Case or **SBR-32MH** Ni-MH Battery Pack (and/or attach the DC power supply), and turn the transceiver on by pressing and holding in the **PWR** switch.
5. Change the setting of Menu #38 (OP FILTER) to "SSB" (if installing the YF-122S), or "CW" (for the YF-122C/YF-122CN).
6. Filter installation is now complete.

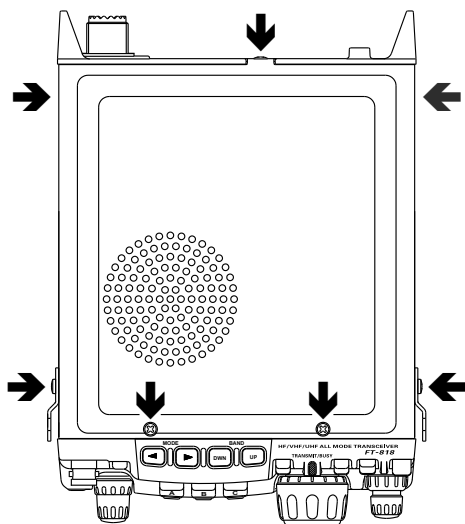
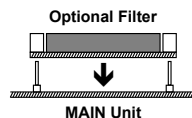

Figure 1

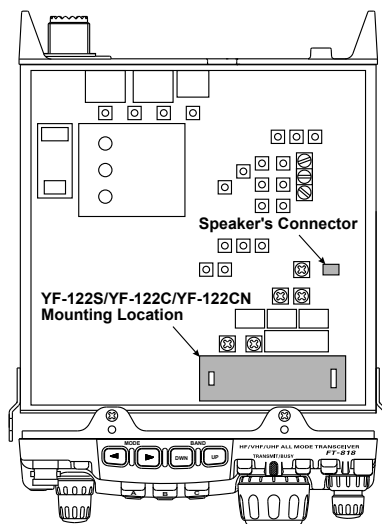

Figure 2

Power-on Microprocessor Reset Procedure

Some or all transceiver settings can be reset to their factory-default states using one of the following power-on routines:

- [V/M] + POWER** on: Reset all memories and following menu setting to factory-default. Menu #06 (AM STEP), 23 (DCS CODE), 30 (FM STEP), 35 (MEM TAG), 42 (RPT SHIFT), 47 (SSB STEP), and 48 (TONE FREQ).
- [F] + POWER** on: Reset all menu setting (except following menu) to factory-default. Menu #06 (AM STEP), 23 (DCS CODE), 30 (FM STEP), 35 (MEM TAG), 42 (RPT SHIFT), 47 (SSB STEP), and 48 (TONE FREQ).
- [HOME] + POWER** on: CPU master reset for all memories and menu setting.

Some menu mode items are not initialized unless turn the power switchoff and on after having performed "Menu Mode Reset" or "All Reset".

Appendix

BAND DATA FORMAT

The **FT-818** BAND DATA Format (available on the ACC jack) is presented below. The BAND DATA line provides a stepped voltage, which denotes the current operating band. This data may be interpreted by an external device (such as an antenna switch or amplifier) to provide automatic band switching.

| BAND | LEVEL | BAND | LEVEL | BAND | LEVEL | BAND | LEVEL |
|---------|--------|--------|--------|----------|--------|---------|--------|
| 1.8 MHz | 0.33 V | 10 MHz | 1.33 V | 21 MHz | 2.33 V | 50 MHz | 3.33 V |
| 3.5 MHz | 0.67 V | 14 MHz | 1.67 V | 24.5 MHz | 2.67 V | 144 MHz | 3.67 V |
| 7 MHz | 1.00 V | 18 MHz | 2.00 V | 28 MHz | 3.00 V | 430 MHz | 4.00 V |

Use shielded cable for interconnections to external devices, so as to prevent RF interference.

Specifications

General

| | |
|----------------------------------|--|
| Frequency Range: | Receive: 100 kHz-30 MHz 50 MHz-54 MHz 76 MHz-154 MHz 420 MHz-470 MHz Transmit: 160-6 Meters 2 Meters 70 Centimeters (Amateur bands only) 5.1675 MHz Alaska Emergency Frequency (USA only) |
| Emission Modes: | A1A (CW), A3E (AM), J3E (LSB/USB), F3E (FM), F1D (9600 bps packet), F2D (1200 bps packet) |
| Synthesizer Steps (Min.): | 10 Hz (CW/SSB), 100 Hz (AM/FM) |
| Antenna Impedance: | 50 Ohms, Unbalanced (Front: Type BNC, Rear: Type M) |
| Operating Temp. Range: | -10 °C to +60 °C (+14 °F to +140 °F) |
| Frequency Stability: | ±0.5 ppm |
| Supply Voltage: | Normal: 13.8 VDC ± 15 %, Negative Ground Operating: 8.0 - 16.0 V, Negative Ground FBA-28 (w/8 "AA" Alkaline Cells): 12.0 V SBR-32MH (Ni-MH Battery Pack): 9.6 V |
| Current Consumption: | Squelched: 250 mA (Approx.) Receive: 450 mA Transmit: 2.4 A (HF/145 MHz), 2.7 A (430 MHz) |
| Case Size (W x H x D): | 135 x 38 x 165 mm (5.31" x 1.5" x 6.50") |
| Weight (Approx.): | 900 g (1.98 lbs) w/o battery, antenna, and Microphone |

Transmitter

| | |
|--------------------------------|--|
| RF Power Output: | 6 W (SSB/CW/FM), 2 W (AM Carrier) @13.8 V |
| Modulation Types: | SSB: Balanced Modulator AM: Early Stage (Low Level) FM: Variable Reactance |
| FM Maximum Deviation: | ±5 kHz (FM-N: ±2.5 kHz) |
| Spurious Radiation: | -50 dB (1.8-29.7 MHz) -60 dB (50/144/430 MHz) |
| Carrier Suppression: | >40 dB |
| Opp. Sideband Supp.: | >50 dB |
| SSB Frequency Response: | 400 Hz-2600 Hz (-6 dB) |
| Microphone Impedance: | 200-10k Ohms (Nominal: 600 Ohms) |

Receiver

| | | | | |
|----------------------------------|--|------------------|-----------|-----------|
| Circuit Type: | Double-Conversion Superheterodyne (SSB/CW/AM/FM) Single-Conversion Superheterodyne (WFM) | | | |
| Intermediate Frequencies: | 1st: 68.33 MHz (SSB/CW/AM/FM); 10.7 MHz (WFM) 2nd: 455 kHz | | | |
| Sensitivity: | | <u>SSB/CW</u> | <u>AM</u> | <u>FM</u> |
| | 100 kHz - 500 kHz | – | – | – |
| | 500 kHz - 1.8 MHz | – | 32 µV | – |
| | 1.8 MHz - 28 MHz | 0.25 µV | 2 µV | – |
| | 28 MHz - 30 MHz | 0.25 µV | 2 µV | 0.5 µV |
| | 50 MHz - 54 MHz | 0.2 µV | 2 µV | 0.32 µV |
| | 144/430 MHz | 0.125 µV | – | 0.2 µV |
| | (IPO, ATT off, SSB/CW/AM = 10 dB S/N, FM = 12 dB SINAD) | | | |
| Squelch Sensitivity: | | <u>SSB/CW/AM</u> | <u>FM</u> | |
| | 1.8 MHz - 28 MHz | 2.5 µV | – | |
| | 28 MHz - 30 MHz | 2.5 µV | 0.32 µV | |
| | 50 MHz - 54 MHz | 1 µV | 0.2 µV | |
| | 144/430 MHz | 0.5 µV | 0.16 µV | |
| | (IPO, ATT off) | | | |
| Image Rejection: | HF/50 MHz: 70 dB 144/430 MHz: 60 dB | | | |
| IF Rejection: | 60 dB | | | |
| Selectivity (–6/–60 dB): | SSB/CW: 2.2 kHz/4.5 kHz AM: 6 kHz/20 kHz FM: 15 kHz/30 kHz FM-N: 9 kHz/25 kHz SSB (optional YF-122S installed): 2.3 kHz/4.7 kHz (–66 dB) CW (optional YF-122C installed): 500 Hz/2.0 kHz CW (optional YF-122CN installed): 300 Hz/1.0 kHz | | | |
| AF Output: | 1.0 W (8 Ohms, 10% THD or less) | | | |
| AF Output Impedance: | 4 - 16 Ohms | | | |

Specifications are subject to change without notice, and are guaranteed within amateur bands only.

Frequency ranges vary according to transceiver version; check with your dealer.

Symbols placed on the equipment

== Direct current

YAESU LIMITED WARRANTY

Limited Warranty is valid only in the country/region where this product was originally purchased.

On-line Warranty Registration:

Thank you for buying YAESU products! We are confident your new radio will serve your needs for many years! Please register your product at www.yaesu.com - Owner's Corner

Warranty Terms:

Subject to the Limitations of the Warranty and the Warranty Procedures described below, YAESU MUSEN hereby warrants this product to be free of defects in materials and workmanship in normal use during the "Warranty Period." (the "Limited Warranty").

Limitations of Warranty:

- A. YAESU MUSEN is not liable for any express warranties except the Limited Warranty described above.
- B. The Limited Warranty is extended only to the original end-use purchaser or the person receiving this product as a gift, and shall not be extended to any other person or transferee.
- C. Unless a different warranty period is stated with this YAESU product, the Warranty Period is three years from the date of retail purchase by the original end-use purchaser.
- D. The Limited Warranty is valid only in the country/region where this product was originally purchased.
- E. During the Warranty Period, YAESU MUSEN will, at its sole option, repair or replace (using new or refurbished replacement parts) any defective parts within a reasonable period of time and free of charge.
- F. The Limited Warranty does not cover shipping cost (including transportation and insurance) from you to us, or any import fees, duties or taxes.
- G. The Limited Warranty does not cover any impairment caused by tampering, misuse, failure to follow instructions supplied with the product, unauthorized modifications, or damage to this product for any reasons, such as: accident; excess moisture; lightning; power surges; connection to improper voltage supply; damage caused by inadequate packing or shipping procedures; loss of, damage to or corruption of stored data; product modification to enable operation in another country/purpose other than the country/purpose for which it was designed, manufactured, approved and/or authorized; or the repair of products damaged by these modifications.
- H. The Limited Warranty applies only to the product as it existed at the time of the original purchase, by the original retail purchaser, and shall not preclude YAESU MUSEN from later making any changes in design, adding to, or otherwise improving subsequent versions of this product, or impose upon YAESU MUSEN any obligation to modify or alter this product to conform to such changes, or improvements.
- I. YAESU MUSEN assumes no responsibility for any consequential damages caused by, or arising out of, any such defect in materials or workmanship.
- J. TO THE FULLEST EXTENT PERMITTED BY LAW, YAESU MUSEN SHALL NOT BE RESPONSIBLE FOR ANY IMPLIED WARRANTY WITH RESPECT TO THIS PRODUCT.
- K. If the original retail purchaser timely complies with the Warranty Procedures described below, and YAESU MUSEN elects to send the purchaser a replacement product rather than repair the "original product", then the Limited Warranty shall apply to the replacement product only for the remainder of the original product Warranty Period.
- L. Warranty statutes vary from state to state, or country to country, so some of the above limitations may not apply to your location.

Warranty Procedures:

1. To find the Authorized YAESU Service Center in your country/region, visit www.yaesu.com. Contact the YAESU Service Center for specific return and shipping instructions, or contact an authorized YAESU dealer/distributor from whom the product was originally purchased.
2. Include proof of original purchase from an authorized YAESU dealer/distributor, and ship the product, freight prepaid, to the address provided by the YAESU Service Center in your country/ region.
3. Upon receipt of this product, returned in accordance with the procedures described above, by the YAESU Authorized Service Center, all reasonable efforts will be expended by YAESU MUSEN to cause this product to conform to its original specifications. YAESU MUSEN will return the repaired product (or a replacement product) free of charge to the original purchaser. The decision to repair or replace this product is the sole discretion of YAESU MUSEN.

Other conditions:

YAESU MUSEN'S MAXIMUM LIABILITY SHALL NOT EXCEED THE ACTUAL PURCHASE PRICE PAID FOR THE PRODUCT. IN NO EVENT SHALL YAESU MUSEN BE LIABLE FOR LOSS OF, DAMAGE TO OR CORRUPTION OF STORED DATA, OR FOR SPECIAL, INCIDENTAL, CONSEQUENTIAL, OR INDIRECT DAMAGES, HOW EVER CAUSED; INCLUDING WITHOUT LIMITATION TO THE REPLACEMENT OF EQUIPMENT AND PROPERTY, AND ANY COSTS OF RECOVERING, PROGRAMMING OR REPRODUCING ANY PROGRAM OR DATA STORED IN OR USED WITH THE YAESU PRODUCT.

Some Countries in Europe and some States of the USA do not allow the exclusion or limitation of incidental or consequential damages, or a limitation on how long an implied warranty lasts, so the above limitation or exclusions may not apply. This warranty provides specific rights, there may be other rights available which may vary between countries in Europe or from state to state within the USA.

This Limited Warranty is void if the label bearing the serial number has been removed or defaced.

1. Changes or modifications to this device not expressly approved by YAESU MUSEN could void the user's authorization to operate this device.
2. This device complies with part 15 of the FCC Rules. Operation is subject to the following two conditions; (1) This device may not cause harmful interference, and (2) this device must accept any interference including received, interference that may cause undesired operation.
3. The scanning receiver in this equipment is incapable of tuning, or readily being altered, by the User to operate within the frequency bands allocated to the Domestic public Cellular Telecommunications Service in Part 22.

This device complies with Industry Canada license-exempt RSS standard(s).

Operation is subject to the following two conditions: (1) this device may not cause interference, and (2) this device must accept any interference, including interference that may cause undesired operation of the device.

Le présent appareil est conforme aux CNR d'Industrie Canada applicables aux appareils radio exempts de licence. L'exploitation est autorisée aux deux conditions suivantes : (1) l'appareil ne doit pas produire de brouillage, et (2) l'utilisateur de l'appareil doit accepter tout brouillage radioélectrique subi, même si le brouillage est susceptible d'en compromettre le fonctionnement.

DECLARATION BY MANUFACTURER

The Scanner receiver is not a digital scanner and is incapable of being converted or modified to a digital scanner receiver by any user.

WARNING: MODIFICATION OF THIS DEVICE TO RECEIVE CELLULAR RADIOTELEPHONE SERVICE SIGNALS IS PROHIBITED UNDER FCC RULES AND FEDERAL LAW.

EU Declaration of Conformity

We, Yaesu Musen Co. Ltd of Tokyo, Japan, hereby declare that this radio equipment FT-818 is in full compliance with EU Radio Equipment Directive 2014/53/EU. The full text of the Declaration of Conformity for this product is available to view at <http://www.yaesu.com/jp/red>

ATTENTION – Conditions of usage

This transceiver works on frequencies that are regulated and not permitted to be used without authorisation in the EU countries shown in this table. Users of this equipment should check with their local spectrum management authority for licensing conditions applicable for this equipment.

| | | | | | | |
|---|----|----|----|----|----|--|
|  | | | | | | |
| AT | BE | BG | CY | CZ | DE | |
| DK | ES | EE | FI | FR | UK | |
| GR | HR | HU | IE | IT | LT | |
| LU | LV | MT | NL | PL | PT | |
| RO | SK | SI | SE | CH | IS | |
| LI | NO | – | – | – | – | |

Disposal of Electronic and Electrical Equipment

Products with the symbol (crossed-out wheeled bin) cannot be disposed as household waste.

Electronic and Electrical Equipment should be recycled at a facility capable of handling these items and their waste by-products.

Please contact a local equipment supplier representative or service center for information about the waste collection system in your country.



YAESU

The radio

Copyright 2018
YAESU MUSEN CO., LTD.
All rights reserved.

No portion of this manual may be
reproduced without the permission of
YAESU MUSEN CO., LTD.

YAESU MUSEN CO., LTD.
Tennozu Parkside Building
2-5-8 Higashi-Shinagawa, Shinagawa-ku, Tokyo
140-0002 Japan

YAESU USA
6125 Phyllis Drive, Cypress, CA 90630, U.S.A.

YAESU UK
Unit 12, Sun Valley Business Park, Winnall Close
Winchester, Hampshire, SO23 0LB, U.K.

1802S-CM
Printed in Japan

