

YAESU

Radio for Professionals

FT-3165R

FT-3165E

Advance Manual

VHF FM TRANSCEIVER

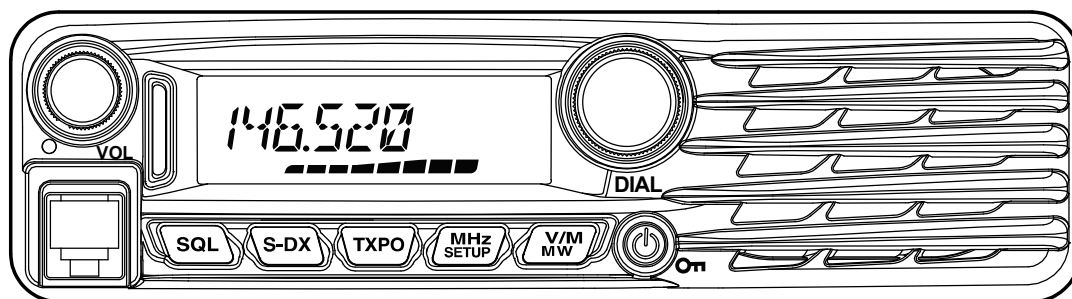

Contents

Basic Operation	3
Microphone Gain Setting.....	3
RF Squelch	3
Advanced Operation	4
Split Tone Operation.....	4
Tone Search	5
DCS Search	6
EPCS (Enhanced Paging & Code Squelch) Operation.....	7
Storing CTCSS Tone Pairs for EPCS Operation.....	7
Activating the Enhanced Paging & Code Squelch System.....	8
DTMF Operation	9
Transmitting a DTMF code manually	9
Registering a DTMF code	10
Transmitting the registered DTMF code.....	11
Setting DTMF Autodialer sending Speed.....	11
Setting DTMF Autodialer TX delay time	12
Memory Operation	13
Split Memory	13
Moving Memory Data to the VFO.....	13
Memory Only Mode.....	13
Naming a Memory Channel	14
Scanning	15
Scan Resume Options	15
Memory Skip Scanning	16
Preferential Memory Scan.....	17
Programmable Memory Scan (PMS)	18
Registering to the programmable memory channels	18
Scanning the programmable memory channels	19
Band Edge Beeper.....	19
Priority Revert Mode	20
Installing the Signal Processing Unit “SPU-1”	21
Clone	22
Setup (Menu) Mode	23
Menu Selection Details	26

Microphone Gain Setting

The microphone gain has been programmed at the factory to a level that should be satisfactory for the supplied SSM-85D Microphone. If an after-market microphone is used, you may wish to set a different Mic Gain level.

1. Press and hold in the **MHz SETUP** key for one second to enter the Set mode.
2. Rotate the **DIAL** knob to select “**12 MIC GAIN**”.
3. Press the **MHz SETUP** key, then rotate the **DIAL** knob to select the desired microphone gain level (LEVEL 1 - LEVEL 9).
Default: LEVEL 5
4. Press and hold in the **MHz SETUP** key for one second to save the new setting and exit to normal operation.

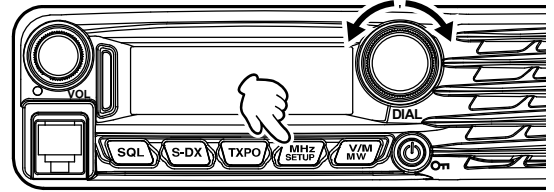

MIC GAIN 12

LEVEL 5

RF Squelch

A special RF Squelch feature is provided on this radio, which allows setting the squelch so that only signals exceeding a pre-set S-meter level will open the squelch.

Use the following procedure to set up the RF squelch circuit for operation:

1. Press and hold in the **MHz SETUP** key for one second to enter the Set mode.
2. Rotate the **DIAL** knob to select “**33 SQL RF**”.
3. Press the **MHz SETUP** key, then rotate the **DIAL** knob to select the desired signal strength level for the squelch threshold (S1 - S8 or OFF).
Default: OFF
4. Press and hold in the **MHz SETUP** key for one second to save the new setting and exit to normal operation.

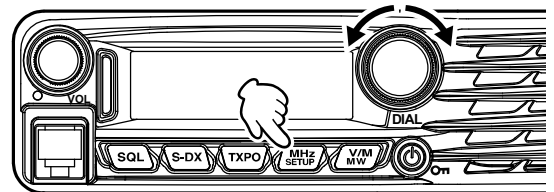



SQL RF 33

S8



Advanced Operation

Split Tone Operation

The FT-3165R/E can be configured to operate in a “Split Tone” system via the Setup menu, to facilitate operation on repeaters using a mix of both CTCSS and DCS control.

1. Press and hold in the  key for one second to enter the Set mode.
2. Rotate the **DIAL** knob to select “**32 SQL EXP**”.
3. Press the  key, then rotate the **DIAL** knob to select “ON”.

Default: OFF

4. Press the  key momentarily, then rotate the **DIAL** knob to select “**28 SQL TYPE**”.
5. Press the  key, and then rotate the **DIAL** knob to select the following parameters.

D CODE: DCS Encode only (the “DCS” icon will blink during operation)

T DCS: Encodes a CTCSS Tone and Decodes a DCS code (the “T” icon will blink and the “DCS” icon will appear during operation)

D TONE: Encodes a DCS code and Decodes a CTCSS Tone (the “T SQ” icon will appear and “DCS” icons will blink during operation)

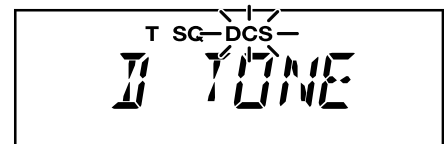
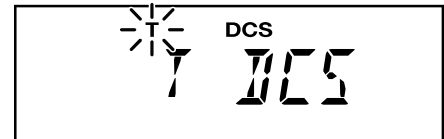
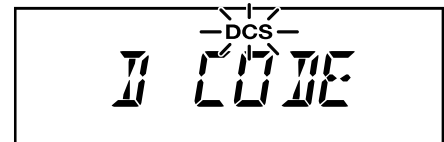
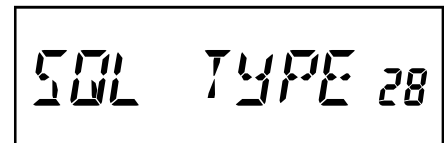
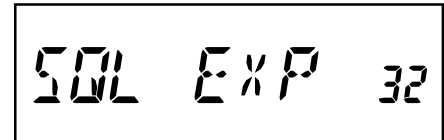
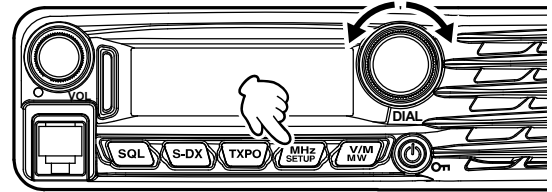

Tone Search

When the CTCSS tone being transmitted by another station is not known, you can tune the radio to the incoming signal and activate tone scan to search for and identify the tone being used.

To scan for the tone in use:

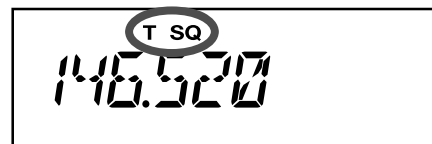

1. Set the transceiver up for CTCSS Decoder operation (see the description in the box shown below.)
“**T SQ**” will appear on the display.



2. Press the Programmable key on the SSM-85D Microphone that is assigned “CD SRCH” (see page 4) to start scanning for the incoming CTCSS code.
3. When the radio detects the correct tone, scanning will halt on that tone, and audio will be allowed to pass.
4. Press the assigned Programmable key of the Microphone to lock in that tone and exit to normal operation.

Note: You may listen to the (muted) signals from the other stations during Tone Scanning when Set Mode Item “**34 TS MUTE**” is set to “**OFF**”. See page 31 for details. You can also change the Tone Search scanning speed, using Set Mode Item “**35 TS SPEED**” See page 31 for details.

CTCSS Decoder Operation

1. Press and hold in the  key for one second to enter the Set mode.
2. Rotate the **DIAL** knob to select “**28 SQL TYPE**”.
3. Press the  key, and then rotate the **DIAL** knob to select “**TSQL**”.
4. Press and hold in the  key for one second to save the new setting and exit to normal operation.

Advanced Operation

DCS Search

When the DCS code being transmitted by another station is not known, you can tune the radio to the incoming signal and activate DCS code scan to search for and identify the DCS code being used.

To scan for the DCS in use:



1. Set the transceiver up for DCS operation (see the description in the box shown below.)
“DCS” will appear on the display.



2. Press the Programmable key on the SSM-85D Microphone that is assigned “CD SRCH” (see page 4) to start scanning for the incoming DCS code.
3. When the radio detects the correct code, scanning will halt on that code, and audio will be allowed to pass.
4. Press the assigned Programmable key of the Microphone to lock in that tone and exit to normal operation.

Note: You may listen to the (muted) signals from the other stations during DCS Scanning when Set Mode Item “**34 TS MUTE**” is set to “**OFF**”. See page 31 for details. You can also change the DCS Search scanning speed, using Set Mode Item “**35 TS SPEED**” See page 31 for details.

DCS Operation

1. Press and hold in the  key for one second to enter the Set mode.
2. Rotate the **DIAL** knob to select “**28 SQL TYPE**”.
3. Press the  key, and then rotate the **DIAL** knob to select “**DCS**”.
4. Press and hold in the  key for one second to save the new setting and exit to normal operation.

EPCS (Enhanced Paging & Code Squelch) Operation

The FT-3165R/E includes an Enhanced CTCSS tone encoder/decoder and a dedicated microprocessor providing paging and selective calling features. This allows placing a call to a specific station (Paging), and choosing to receive calls directed only to you (Code Squelch).

The paging and code squelch systems use two pairs of (alternately switched) CTCSS tones, which are stored in the pager memories. Basically, your receiver remains silent until it receives the CTCSS tone pair that matches those stored in the Receiving Pager Memory. The squelch then opens so the caller is heard, and the paging ringer immediately sounds, if activated. When you close the PTT switch to transmit, the CTCSS tone pair that is stored in the Transmitting Pager Memory will be transmitted automatically.

On the paged radio, the squelch will close automatically after the incoming page ends.

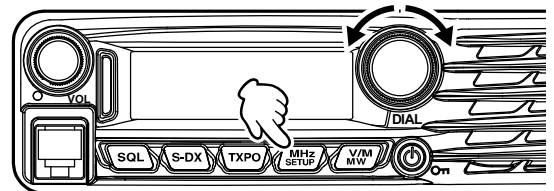

Storing CTCSS Tone Pairs for EPCS Operation

1. Press and hold in the  key for one second to enter the Set mode.
2. Rotate the **DIAL** knob to select “**20 PAG CD-R**” for the Receiving CTCSS Tone Pair or “**21 PAG CD-T**” for the Transmitting CTCSS Tone Pair.



PAG CD-R 20

PAG CD-T 21

3. Press the  key momentarily to enable adjustment of this Set Mode Item.
4. Rotate the **DIAL** knob to set the CTCSS Tone number, which corresponds to the first tone of the CTCSS Tone Pair.
5. Press the  or  key, then rotate the **DIAL** knob to set the CTCSS Tone number, which corresponds to the second tone of the CTCSS Tone Pair.

*05 47

05 *50

6. Press and hold in the  key for one second to lock in that tone and exit to normal operation.

Note: The FT-3165R/E does not recognize the order of the 1st tone and the 2nd tone. In other words, for example, the FT-3165R/E considers both CTCSS pairs “05, 47” and “47, 05” to be identical.

Advanced Operation

Activating the Enhanced Paging & Code Squelch System

1. Press and hold in the **MHz SETUP** key for one second to enter the Set mode.
2. Rotate the **DIAL** knob to select “**28 SQL TYPE**”.

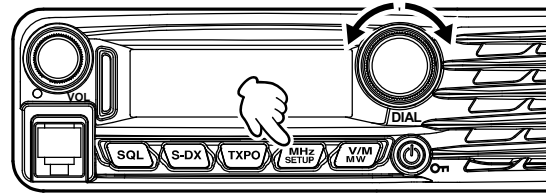

SQL TYPE 28

3. Press the **MHz SETUP** key, and then rotate the **DIAL** knob to select “**PAGER**”.

PAGER

4. Press and hold in the **MHz SETUP** key for one second to save the new setting and exit to normal operation.
5. To disable the Enhanced Paging & Code Squelch, just repeat the above procedure, rotating the **DIAL** knob to select “**OFF**” in step 3 above.

When the Enhanced Paging & Code Squelch feature is activated, the “**P**” notation will appear on the right of the frequency display.

146.520 P

DTMF Operation

DTMF tones (Dual Tone Multi Frequencies) are the tones you hear when dialing from a telephone keypad. The FT-3165R/E transceiver can transmit the DTMF codes by using the keys on the microphone or recalling registered number strings from memories.

The maximum of 16-digit DTMF codes can be registered in up to 10 memory channels. It is convenient to register telephone patch numbers, and network linking sequences to the DTMF memory channels.

Note: The two combined frequencies of the DTMF tone transmitted for each key are indicated in the following table:

	1209 Hz	1336 Hz	1477 Hz	1633 Hz
697 Hz	1	2	3	A
770 Hz	4	5	6	B
852 Hz	7	8	9	C
941 Hz	*	0	#	D

Transmitting a DTMF code manually

You can generate DTMF tones during transmission manually.

1. Press and hold in the **MHz SETUP** key for one second to enter the Set mode.
2. Rotate the **DIAL** knob to select “8 DT AUTO”.

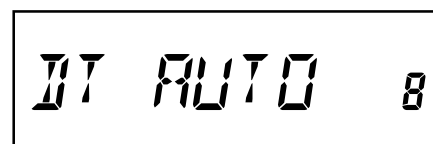
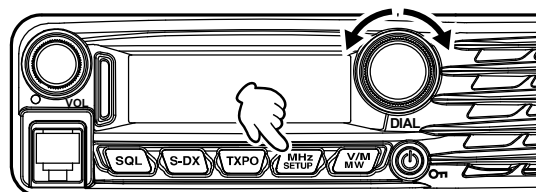

3. Press the **MHz SETUP** key momentarily, and then rotate the **DIAL** knob to select “MANUAL”.



4. Press and hold in the **MHz SETUP** key for one second to save the new setting and exit to normal operation.
5. While pressing and holding **PTT**, press the desired DTMF characters ([0] to [9], [*], [#], or [A] to [D]), sequentially on the microphone keypad.
6. Release **PTT**.



While transmitting the DTMF code, transmission status is sustained even when **PTT** is released.

Advanced Operation

Registering a DTMF code

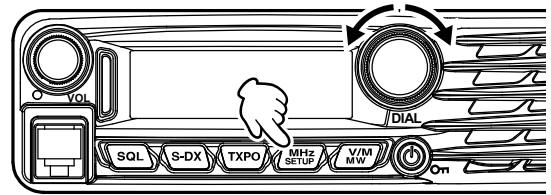
1. Press and hold in the  key for one second to enter the Set mode.
2. Rotate the **DIAL** knob to select “9 DT EDIT”.



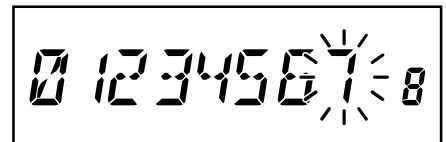
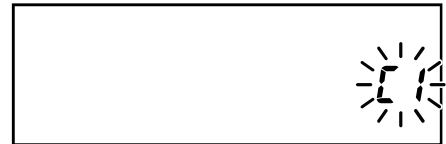

3. Press the  key momentarily, then rotate the **DIAL** knob to select the desired memory channel (C0 to C9) to register the DTMF code.
4. Press the  key momentarily, then rotate the **DIAL** knob to select the first digit of the DTMF code.



- Note:** You can also use the keypad on the microphone to input the DTMF code.
5. When you have selected the correct digit, press the  key momentarily. Now, rotate the **DIAL** knob to select the second of 16 available numbers in the current DTMF Autodialer memory register.
 6. Repeat this procedure for each digit in the DTMF code.

Note: ○ To make a correction, press the  key to back-space the cursor, then re-enter the correct number.

○ Press and hold in the  key for one second to delete all data after the cursor that may have been previously stored.
 7. When entry of all digits is complete, press and hold in the  key for one second to set the DTMF code and exit to normal operation.

Transmitting the registered DTMF code

1. Press and hold in the  key for one second to enter the Set mode.
2. Rotate the **DIAL** knob to select “8 DT AUTO”.

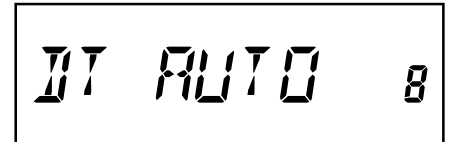
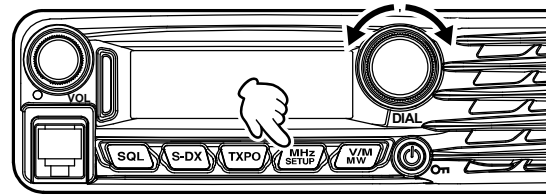

3. Press the  key momentarily, and then rotate the **DIAL** knob to select “AUTO”.



4. Press and hold in the  key for one second to save the new setting and exit to normal operation.

Note: While the DTMF Autodialer is activated, the  icon will appear on the LCD.





5. In the Autodialer mode, which you just engaged, first press the **PTT** switch, then press the microphone numeric key ([0] through [9]) corresponding to the DTMF memory string you wish to send. Once the string begins, you may release the **PTT** switch, as the transmitter will be held “on the air” until the DTMF string is completed.

To disable the Autodialer function mode, select “MANUAL” in step 3 above.

Setting DTMF Autodialer sending Speed

The speed at which the DTMF digits are sent can be changed.

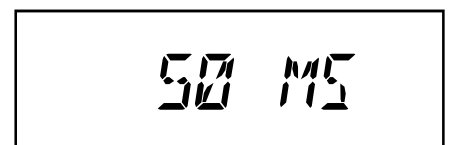
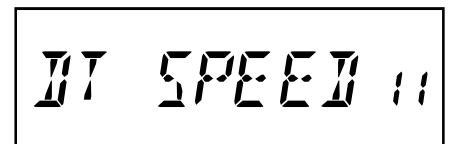
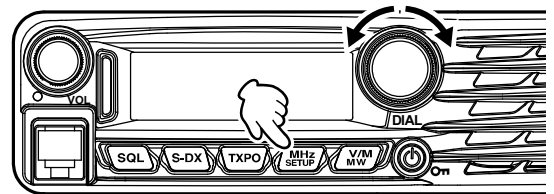

1. Press and hold in the  key for one second to enter the Set mode.
2. Rotate the **DIAL** knob to select “11 DT SPEED”.
3. Press the  key momentarily, and then rotate the **DIAL** knob to select the desired speed (“50 MS”: High speed or “100 MS”: Low speed).
4. Press and hold in the  key for one second to save the new setting and exit to normal operation.



Advanced Operation

Setting DTMF Autodialer TX delay time

A longer delay may be set between the time the transmitter is keyed and the first DTMF digit is sent:

1. Press and hold in the  key for one second to enter the Set mode.
2. Rotate the **DIAL** knob to select “**10 DT DELAY**”.
3. Press the  key momentarily, and then rotate the **DIAL** knob to select the desired delay time (50 MS / 250 MS / 450 MS / 750 MS / 1000 MS).

Default: 450 MS

4. Press and hold in the  key for one second to save the new setting and exit to normal operation.

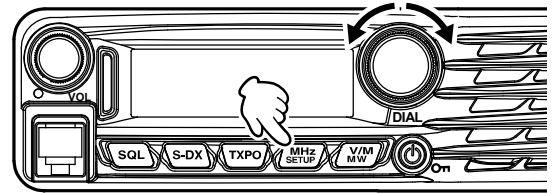



DT DELAY 10

450 MS

Split Memory

A separate transmit frequency may be registered to a memory channel to which a receive frequency has already been registered.



1. In the VFO mode, select the transmit frequency to be registered.
2. Press and hold the  key for one second.
A memory number will appear in the bottom right corner of the display.
3. Within five seconds of pressing  key, rotate the **DIAL** knob (if necessary) to select the memory channel to which the transmit frequency is to be registered.
4. Press and hold in the **PTT**, and press the  key momentarily while holding in the **PTT**. This will not cause transmission, but rather it will instruct the transceiver to program the separate *transmit* frequency into memory.

Whenever a memory which contains independently stored transmit and receive frequencies is recalled, the “- +” indication will appear in the display.



Moving Memory Data to the VFO

The data stored on a memory channel can easily be moved to the VFO.

1. Select the memory channel containing the frequency data to be moved to the VFO.
2. Press and hold in the  key for one second, and then press the  key. The “VFO WRT?” will appear on the display.
3. Press the  key, the data will now have been copied to the VFO, although the original memory contents will remain intact on the previously-stored channel.

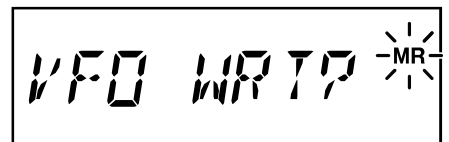

Note: If a split Frequency Memory channel was transferred, the TX frequency will be ignored (The transceiver will be set up for Simplex operation on the Receive frequency.)

Memory Only Mode

When memory channel programming has been completed, you may place the radio in a “Memory Only” mode, whereby VFO operation is impossible. This may be particularly useful during public-service events where a number of operators may be using the radio for first time, and ultimate simplicity of channel selection is desired.

To place the radio into the Memory Only mode, turn the transceiver OFF. Now press and hold in the  key while turning the transceiver ON. The VFO and Home Channel will now be disabled.

To return to normal operation, repeat the above power-on procedure.

Memory Operation

Naming a Memory Channel

You may wish to append an alphanumeric “Tag” (label) to each memory, to aid in recollection of the channel’s use (such as club name, etc.).

1. Recall the memory channel on which you wish to append a label.

2. Press and hold in the **MHz SETUP** key for one second to enter the Set mode.

3. Rotate the **DIAL** knob to select “13 MEM NAME”.

4. Press the **MHz SETUP** key momentarily to enable programming of the name tag.

5. Rotate the **DIAL** knob to select the first digit of the desired label.

6. Press the **V/M MW** key to move to the next character.

Note: To make a correction, press the **SQL** key to back-space the cursor, then re-enter the correct letter, number, or symbol.

7. Repeat steps 5 through 6 to program the remaining letters, numbers, or symbols of the desired label. A total of 8 characters may be used in the creation of a label.

8. When you have programmed a label that is under 8 characters, press the **MHz SETUP** key to confirm the label.

Note: Press and hold in the **S-DX** key for one second to delete all data after the cursor that may have been previously stored.

9. When you have completed the creation of the label, then press and hold in the **MHz SETUP** key for one second to save the label and exit.

While operating in the Memory Recall mode, press the **MHz SETUP** key to toggle the display between indication of the frequency, and indication of the Alpha/Numeric label.

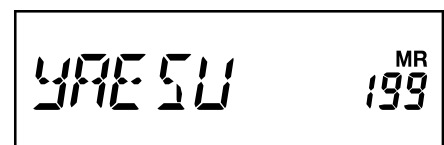
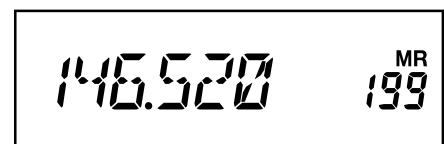
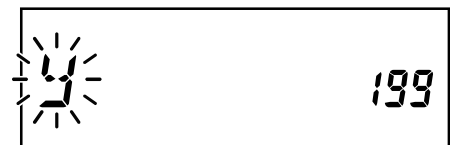
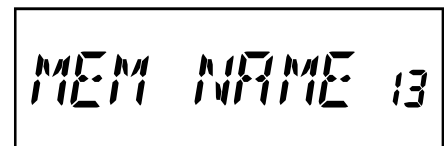
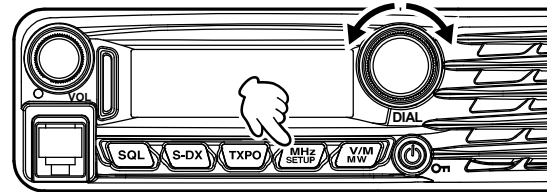

Scan Resume Options

Select one of the three receiving operations to be performed after the scanning stops.

- (1) Restart scanning after receiving the frequency for the set amount of time. Select from 2.0 to 10.0 seconds (0.5 step).
- (2) Continue receiving the frequency until the signal disappears, and then restart scanning 2 seconds after the signal disappears (BUSY).
- (3) Stop scanning and receive that frequency (HOLD).

1. Press and hold in the **MHz SETUP** key for one second to enter the Set mode.
2. Rotate the **DIAL** knob to select “**25 SCAN RSM**”.
3. Press the **MHz SETUP** key, then rotate the **DIAL** knob to select the desired scan-resume mode.

Default: 5.0 SEC

4. Press and hold in the **MHz SETUP** key for one second to save the new setting and exit to normal operation.

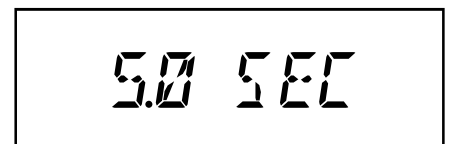
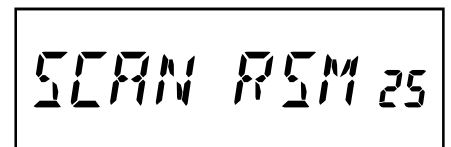
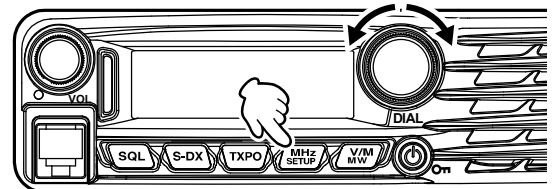

Scanning

Memory Skip Scanning

When some memory channels are continuously active, you may wish to *skip* them during *scanning*, but still have them available for *manual selection*.

To mask a memory to be skipped (only) during scanning, use the following procedure:

1. Set the radio to the Memory Recall mode by pressing the **V/M MW** key repeatedly, as necessary, until “**MR**” and a channel number appear on the right side of the display.
2. Rotate the **DIAL** knob to select the Memory Channel to be skipped during scanning.
3. Press and hold in the **MHz SETUP** key for one second, then rotate the **DIAL** knob to select “**26 SCAN SKP**”.
4. Press the **MHz SETUP** key, then rotate the **DIAL** knob to select “**SKIP**”. The current Memory Channel will now be ignored during scanning.
5. Press and hold in the **MHz SETUP** key for one second to save the new setting and exit to normal operation.

A blinking “▶” icon will appear when you recall the “skipped” memory channel manually.

To reinstate a channel into the scanning loop, select “OFF” in step 4 above, after first recalling the currently blocked channel (the “Skipped” channel is accessible via manual channel selection methods using the **DIAL** knob in the Memory mode, whether or not it is locked out of the scanning loop).

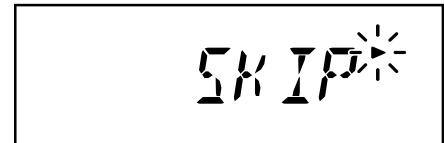
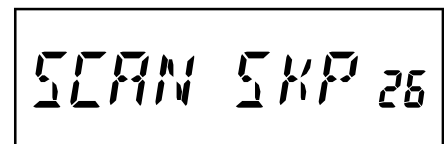
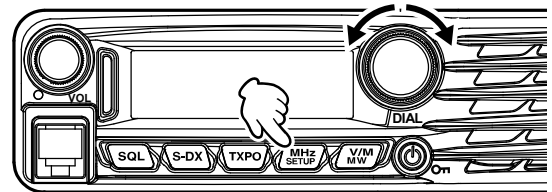
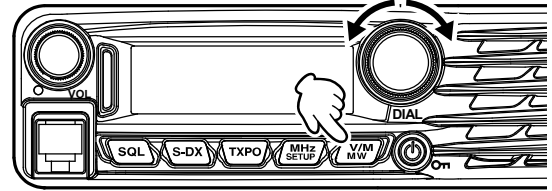



Preferential Memory Scan



The FT-3165R/E also allows setting up a “Preferential Scan List” of channels, which you can “flag” within the memory system. The flagged channels are designated by an “▶” icon when they are selected, one by one, for the Preferential Scan List.

When memory scanning is initiated beginning on a channel with the “▶” icon appended, only those channels bearing the “▶” icon will be scanned. If scanning is initiated on a channel which does not have the “▶” icon appended, all channels including those with the “▶” icon appended will be scanned.

Here is the procedure for setting up and using the Preferential Scan List:

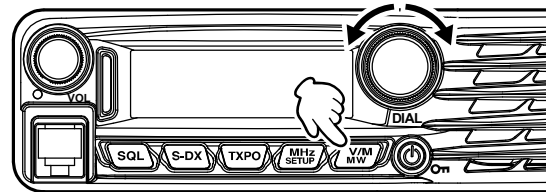
1. Set the radio to the Memory Recall mode by pressing the  key repeatedly, as necessary, until “MR” and a channel number appear on the right side of the display.
2. Rotate the **DIAL** knob to select the Memory Channel that you wish to add to the preferential Scan List.
3. Press and hold in the  key for one second, then rotate the **DIAL** knob to select “26 SCAN SKP”.



4. Press the  key, and then rotate the **DIAL** knob to select “SELECT”.
5. Press and hold in the  key for one second to save the new setting and exit to normal operation.

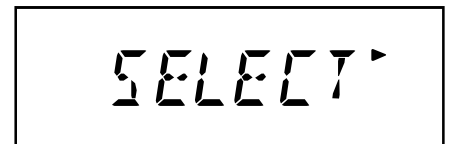
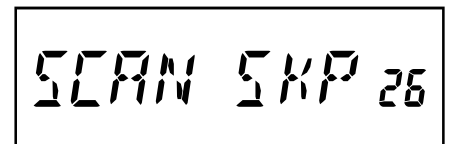
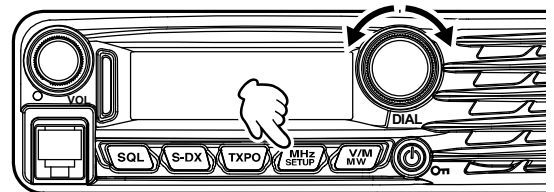

To initiate Preferential Memory Scanning:

1. Set the radio to the Memory Recall mode by pressing the  key repeatedly, if necessary.
2. Rotate the **DIAL** knob to select any memory channel which has an “▶” icon appended to the channel number.
3. Press and hold in either the microphone [UP] or [DWN] button for one second to initiate Preferential Memory Scanning. Only the channels which have a “▶” icon appended to the channel number will be scanned.



Scanning

Programmable Memory Scan (PMS)

The FT-3165R/E can be set to tune or scan only the frequencies between user-defined lower and band limits.

Example: Set up a PMS channel by registering a lower frequency of 144.300MHz, and an upper frequency of 145.000MHz to the L1/U1 memory channels.

Registering to the programmable memory channels

1. In the VFO mode, select the desired lower-limit scan frequency (144.300MHz).
2. Press and hold the  key for one second. A memory number will appear in the bottom right corner of the display.
3. Rotate the **DIAL** knob to select "L1".

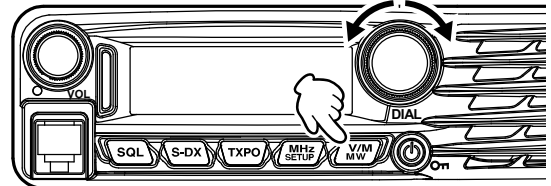

Note: While operating in the Memory Storage mode, the keypad of the SSM-85D Microphone may be used to enter the memory channel number directly.

To do this, enter the desired Channel Number (see table below) on the keypad and then press the [#] key.

To enter Memory Channel "L1", press [2] → [0] → [1] → [#]

To enter Memory Channel "U0", press [2] → [2] → [0] → [#]

L1	201	L3	205	L5	209	L7	213	L9	217
U1	202	U3	206	U5	210	U7	214	U9	218
L2	203	L4	207	L6	211	L8	215	L0	219
U2	204	U4	208	U6	212	U8	216	U0	220

4. Press the  key again, momentarily, to store the displayed data into the memory channel (L1).
5. Select the desired upper-limit scanning frequency (145.000MHz).

6. Press and hold the  key, then rotate the **DIAL** knob to select "U1".

7. Press the  key again, momentarily, to store the displayed data into the memory channel (U1).



Scanning the programmable memory channels

1. Press the  key to enter memory mode.
2. Turn the **DIAL** knob, or use the microphone keypad, to recall the upper or lower frequency PMS memory channel (L1 or U1).
3. Press the [#] key on the SSM-85D Microphone.
“P1” appear on the right side of the display.
4. Press and hold [UP] or [DWN] on the microphone for over one second.
Programmable memory scanning will begin.





- Note:** To stop programmable memory scanning, press **PTT** on the microphone (this does not cancel PMS mode).
To cancel PMS mode, when programmable memory scanning stops, press the [#] key on the SSM-85D Microphone.

Band Edge Beeper

The FT-3165R/E will automatically “beep” when the receive band edge is encountered during scanning (either in standard VFO scanning or during PMS operation). Additionally, the band edge beep feature may be enabled to sound when the band edge frequency is reached while tuning the VFO, using the **DIAL** knob.

The procedure to enable the Band-Edge Beeper (during manual tuning) is:

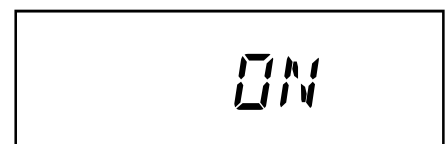
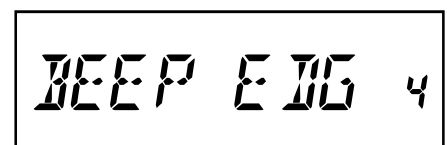
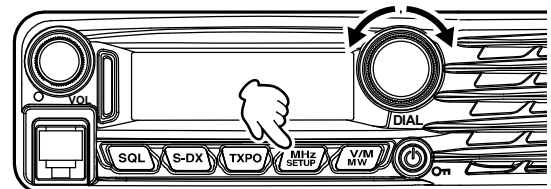

1. Press and hold in the  key for one second, then rotate the **DIAL** knob to select “4 BEEP EDG”.
2. Press the  key, and then rotate the **DIAL** knob to set this Menu item to “ON”.
3. Press and hold in the  key for one second to save the new setting and exit to normal operation.



Priority Revert Mode

During Priority channel operation (Dual Watch), a special feature is available which will allow you to move to the Priority Channel instantly, without waiting for activity to appear on the Priority Channel.

When this feature is enabled, and priority monitoring is engaged, just press the microphone **PTT** switch. Operation will instantly revert to the Priority Channel.

1. Press and hold in the  key for one second, then rotate the **DIAL** knob to select “**27 DW REVRT**”.
2. Press the  key, and then rotate the **DIAL** knob to set this Menu item to “**ON**”.
3. Press and hold in the  key for one second to save the new setting and exit to normal operation.



27 DW REVRT 27



ON

To disable Priority Revert operation, select “OFF” in step 2 above.

Installing the Signal Processing Unit “SPU-1”

Caution!

Avoid touching the electronic components with your hands as the semiconductors may be damaged by static electricity.

1. Turn the transceiver OFF. Also turn OFF the external DC power supply.
2. Disconnect all the cables and the microphone from the transceiver.
3. Remove the three screws from the top cover, (one on top and two at the sides).
4. Remove the top cover from the transceiver chassis.
5. Refer to the illustration for the mounting location of the SPU-1. Align the triangle marks and plug the SPU-1 toward the rear, all the way into the connector.
6. Fasten the SPU-1 into place using the two screws supplied with the SPU-1.
Do not use incorrect screws, only use the supplied screws.
7. The SPU-1 installation is now complete.
8. Replace the top cover and secure it using the three screws.
9. Connect all the cables and the microphone to the transceiver.

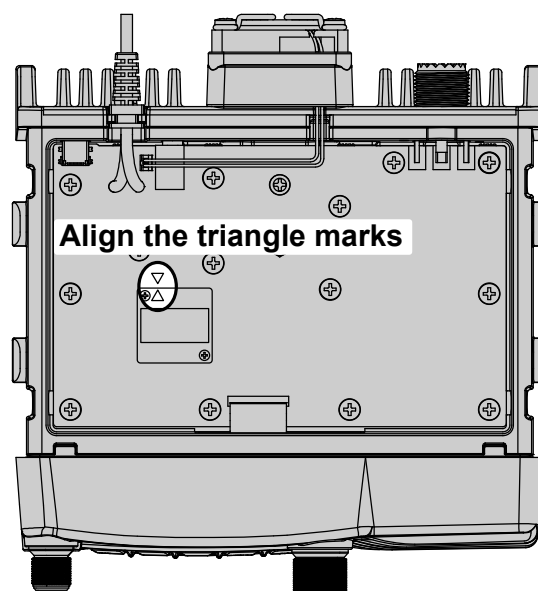
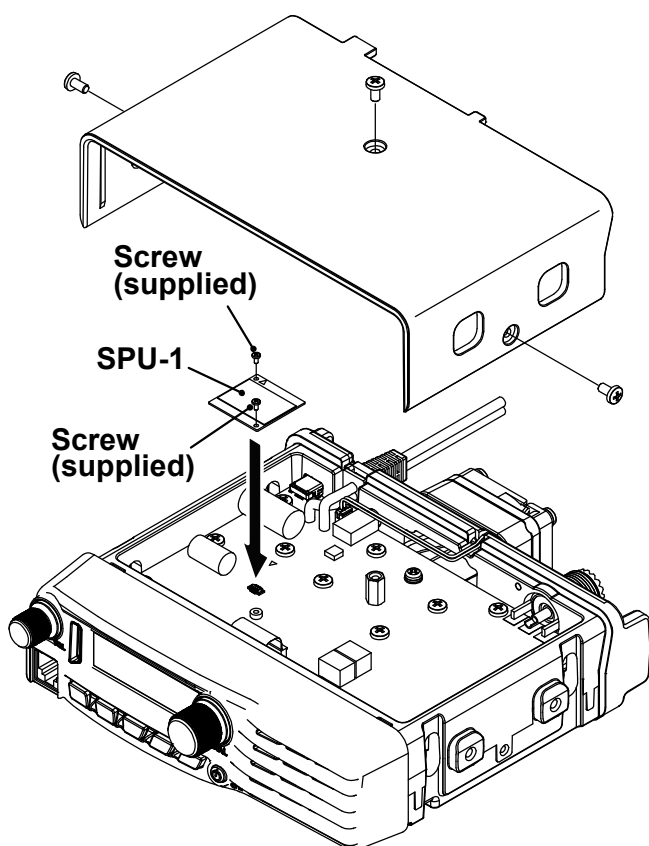

Clone

The FT-3165R/E includes a convenient “Clone” feature, which allows the memory and configuration data from one transceiver to be transferred to another FT-3165R/E.

This can be particularly useful when configuring a number of transceivers for a public service operation.

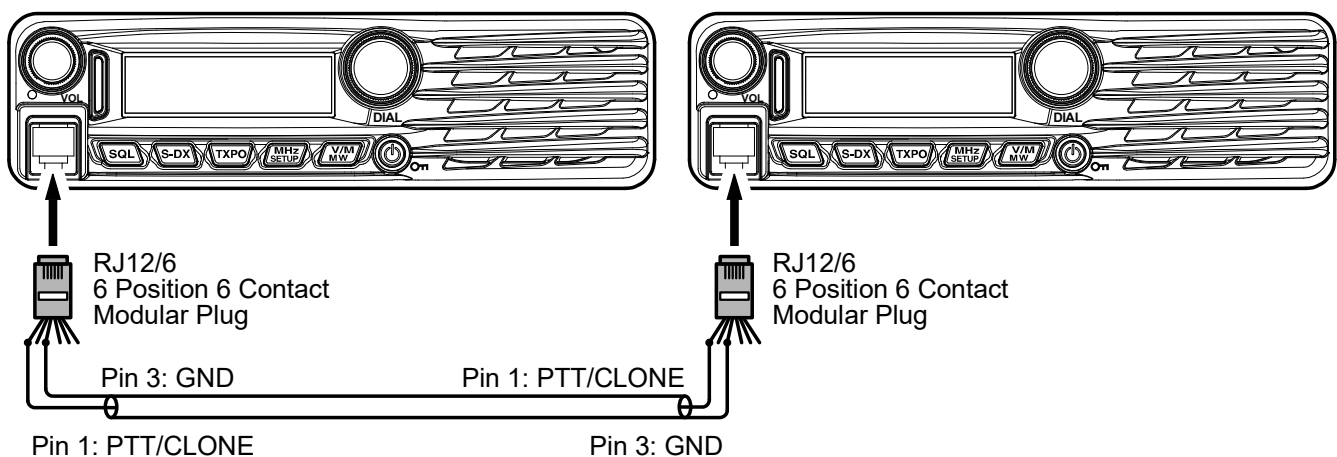
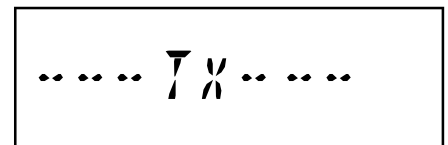
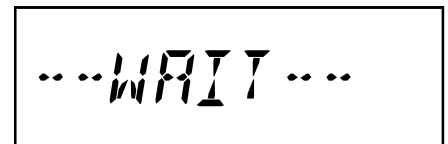
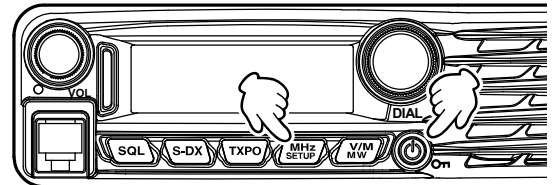

Here is the procedure for cloning data from one radio to another:

1. Turn both radios OFF.
2. Connect the user-constructed cloning cable between the MIC jacks of the two radios.
3. Press and hold in the **MHZ SETUP** key while turning the radios ON. Do this for both radios (the order of switch-on does not matter). “CLONE” will appear on the displays of both radios when the Clone mode is successfully activated in this step.
4. On the Destination radio; press the **MHZ SETUP** key (“-- --WAIT-- --” will appear on the display).
5. On the Source radio; press the **S-DX** key (“-- --TX-- -- --” will appear on the Source radio, and the data from this radio will be transferred to the destination radio.
6. If there is a problem during the cloning process, “ERROR” will be displayed. Check your cable connections and battery voltage, and try again.
7. If the data transfer is successful, “CLONE” will appear on the Source radio display. The destination radio, to which the data is copied, will restart automatically.
8. Turn both radios off and disconnect the cloning cable.



Setup (Menu) Mode

The FT-3165R/E Setup (Menu) mode, already described in parts of many previous chapters, is easy to activate and setup. The Menus may be used to configure many of transceiver parameters, some of which have not been detailed previously. Use the following procedure to activate the Setup (Menu) mode:

1. Press and hold the  key for one second to enter the Setup menu.
2. Rotate the **DIAL** knob to select the Menu Item to be adjusted.
3. Press the  key momentarily to enable adjustment of the selected Menu item, and then rotate the **DIAL** knob to perform the actual adjustment.
4. After completing the selection and adjustment, press and hold the  key for one second to exit the Setup menu and resume normal operation.

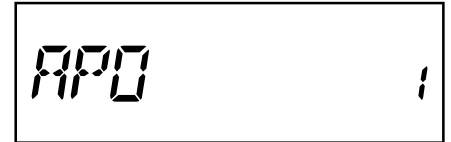
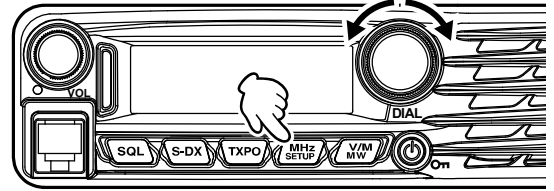

Menu Item	Function	Available Values	Default
1: APO	Enables/Disables the Automatic Power Off feature.	0.5H to 12H (0.5H step)/ OFF	OFF
2: BCLO	Enables/Disables the Busy Channel Lock-Out feature.	ON / OFF	OFF
3: BEEP KEY	Enables/Disables the key beeper.	KEY+SCAN / KEY / OFF	KEY+SCAN
4: BEEP EDG	Enables/Disable the Band-edge beeper while scanning.	ON / OFF	OFF
5: BELL	Selects the CTCSS/DCS/EPCS Bell Ringer repetitions.	1 to 20 / CONTINUE/ OFF	OFF
6: CLK TYPE	Shifting of the CPU clock frequency.	A / B	A
7: DIMMER	Setting of the front panel display illumination level.	MAX / MID 1 / MID 2 / OFF	OFF
8: DT AUTO	Enables/Disables the DTMF Autodialer feature.	MANUAL / AUTO	MANUAL
9: DT EDIT	Loading of the DTMF Autodialer Memories.	---	---
10: DT DELAY	Setting of the DTMF Autodialer TX Delay Time.	50 / 250 / 450 / 750 / 1000	450 MS
11: DT SPEED	Setting of the DTMF Autodialer Sending Speed.	50 / 100	50 MS
12: MIC GAIN	Adjust the microphone gain level.	LEVEL 1 to 9	LEVEL 5
13: MEM NAME	Programming an Alpha/Numeric label for a Memory Channel.	---	---
14: MW MODE	Selects the method of selecting of channels for Memory Storage.	NEXT CH / LOWER CH	NEXT CH
15: OPEN MSG	Selects the Opening Message that appears when the transceiver is powered ON.	OFF / DC / MESSAGE	MESSAGE

Setup (Menu) Mode

Menu Item	Function	Available Values	Default
16: PGM P1	Programming the function assigned to Microphone [P1] key.	SQL OFF HOME WX CH	SQL OFF
17: PGM P2	Programming the function assigned to Microphone [P2] key.	CD SRCH SCAN T CALL	HOME
18: PGM P3	Programming the function assigned to Microphone [P3] key.	TX POWER REV DW	REV
19: PGM P4	Programming the function assigned to Microphone [P4] key.	Setup Menu Item #1 to 44	✖
20: PAG CD-R	Setting the Receiver Pager Code for the Enhanced CTCSS Paging & Code Squelch function.	---	05 47
21: PAG CD-T	Setting the Transmitting Pager Code for the Enhanced CTCSS Paging & Code Squelch function.	---	05 47
22: RPT SFT	Sets the Repeater Shift direction.	-RPT / +RPT / SIMPLEX	SIMPLEX
23: RPT ARS	Activates/Deactivates the Automatic Repeater Shift feature.	ON / OFF	ON
24: RPT FREQ	Sets the magnitude of the Repeater Shift.	0.00 - 150.00 (MHz)	0.60MHz
25: SCAN RSM	Selects the Scan Resume mode.	BUSY / HOLD/2-10 (SEC)	5.0 SEC
26: SCAN SKP	Selects the Memory Scan mode.	OFF / SKIP / SELECT	OFF
27: DW REVRT	Enables/Disables the "Priority Channel Revert" feature.	ON / OFF	OFF
28: SQL TYPE	Selects the Tone Encoder and/or Decoder mode.	TONE / TSQL / DCS / RV TONE / PAGER / OFF	OFF
29: TONE FRQ	Setting of the CTCSS Tone Frequency.	67.0 to 254.1 (Hz)	100.0Hz
30: DCS CODE	Setting of the DCS code.	104 standard DCS codes	023
31: DCS INV	Select a combination of DCS inversion codes in terms of communication direction.	NORMAL / INVERT/ BOTH	NORMAL
32: SQL EXP	Sets the squelch type separately for transmission and reception.	ON / OFF	OFF
33: SQL RF	Adjusts the RF Squelch threshold level.	OFF / S1 to S8	OFF
34: TS MUTE	Enables/Disables the receiver audio output while the Tone Search or DCS Search Scanner is activated.	ON / OFF	ON
35: TS SPEED	Selects the Tone Search or DCS Search Scanner speed.	FAST / SLOW	FAST
36: LOCK	Selects the Control Locking Lockout combination.	KEY+DIAL / PTT / KEY+PTT / DIAL+PTT / ALL / KEY / DIAL	KEY+DIAL
37: STEP	Sets the frequency synthesizer steps.	AUTO / 5 / 6.25 / 10 / 12.5 / 15 / 20 / 25 / 50 / 100 (kHz)	AUTO

Setup (Menu) Mode

Menu Item	Function	Available Values	Default
38: TOT	Sets the Time-Out Timer.	0.5 to 10.0 (MIN) / OFF	※
39: TEMP	Indicates the current temperature inside the transceiver.	---	---
40: VOLT	Indicates the DC Supply Voltage.	---	---
41: VER DISP	Displays the transceiver software version	CPU x.xx	---
42: WIDTH	Reduction of the Microphone Gain/Deviation and receiver bandwidth.	WIDE / NARROW	WIDE
43: WX ALERT	Enables/Disables the Weather Alert feature.	ON / OFF	OFF
44: WX VOL	Selects the audio output level of the Weather Alert.	NOR VOL / MAX VOL	NOR VOL

※: Depends on the transceiver version.

Menu Selection Details

1 APO

Function: Enables/Disables the Automatic Power Off feature.

Available Values: 0.5 H to 12.0 H (0.5 H/step) / OFF

Default: OFF

2 BCLO

Function: Enables/Disables the Busy Channel Lock-Out feature.

Available Values: ON / OFF

Default: OFF

3 BEEP KEY

Function: Enables/Disables the key beeper.

Available Values: KEY+SCAN / KEY / OFF

Default: KEY+SCAN

KEY+SCAN: The beeper sounds when any key is pressed, or when the scanner stops.

KEY: The beeper sounds when any key is pressed.

OFF: Beeper is disabled.

4 BEEP EDG

Function: Enables/Disable the Band-edge beeper while scanning.

Available Values: ON / OFF

Default: OFF

5 BELL

Function: Selects the CTCSS/DCS/EPCS Bell Ringer repetitions.

Available Values: 1 TIME to 20 TIMES / CONTINUE (Continuous ringing) / OFF

Default: OFF

6 CLK TYPE

Function: Shifting of the CPU clock frequency.

Available Values: A / B

Default: A

This function is only used to move a spurious response “birdie”, should it fall on a desired frequency. Select “A” for the normal operation.

7 DIMMER

Function: Setting of the front panel display’s illumination level.

Available Values: MAX / MID 1 / MID 2 / OFF

Default: OFF

8 DT AUTO

Function: Enables/Disables the DTMF Autodialer feature.

Available Values: MANUAL / AUTO

Default: MANUAL

9 DT EDIT

Function: Loading of the DTMF Autodialer Memories.

See page 10 for details.

10 DT DELAY

Function: Setting of the DTMF Autodialer's TX Delay Time.

Available Values: 50 / 250 / 450 / 750 / 1000 ms

Default: 450 ms

11 DT SPEED

Function: Setting of the DTMF Autodialer Sending Speed.

Available Values: 50 (high speed) / 100 (low speed) ms

Default: 50 ms

12 MIC GAIN

Function: Adjust the microphone gain level.

Available Values: LEVEL 1 - LEVEL 9

Default: LEVEL 5

13 MEM NAME

Function: Programming an Alpha/Numeric label for a Memory Channel.

See page 14 for details.

14 MW MODE

Function: Selects the method of selecting of channels for Memory Storage.

Available Values: NEXT CH / LOWER CH

Default: NEXT CH

NEXT CH: Stores the data into the memory channel which is next-highest from the *last-stored* memory channel.

LOWER CH: Stores the data into the lowest-available "free" channel.

15 OPEN MSG

Function: Selects the Opening Message that appears when the radio is powered ON.

Available Values: DC / MESSAGE / OFF



Default: MESSAGE

DC: DC supply voltage

MESSAGE: Set by user. See below.

OFF: No Opening Message

Here's how to program the Opening Message:

1. Set this Set Mode Item to "MESSAGE".
2. Press the  key momentarily to enable programming of the opening message. You will notice the first character entry's location blinking.
3. Rotate the **DIAL** knob to select the first letter/number of the message, and then press the  key momentarily to move to the next character.
4. Repeat the previous step as necessary to complete the message (up to 8 characters).

Menu Selection Details

5. To correct a mistake, press the **SQL** key to backspace the cursor; now re-enter the correct letter/number.
6. When the desired opening message is completed, press the **TXPO** key momentarily to confirm the message, then press and hold in the **MHZ SETUP** key for one second to save the settings and exit to normal operation.

16 PGM P1

Function: Programming the function assigned to Microphone [P1] key.

Available Values: SQL OFF / HOME / WX CH / CD SRCH / SCAN / T CALL / TX POWER REV / DW or one of the all Set mode items (except Set mode items #16 through 19; initial setting is "Set mode item #40 VOLT").

Default: SQL OFF

17 PGM P2

Function: Programming the function assigned to Microphone [P2] key.

Available Values: SQL OFF / HOME / WX CH / CD SRCH / SCAN / T CALL / TX POWER REV / DW or one of the all Set mode items (except Set mode items #16 through 19; initial setting is "Set mode item #7 DIMMER").

Default: HOME

18 PGM P3

Function: Programming the function assigned to Microphone [P3] key.

Available Values: SQL OFF / HOME / WX CH / CD SRCH / SCAN / T CALL / TX POWER REV / DW or one of the all Set mode items (except Set mode items #16 through 19; initial setting is "Set mode item #12 MIC GAIN").

Default: REV

19 PGM P4

Function: Programming the function assigned to Microphone [P4] key.

Available Values: SQL OFF / HOME / WX CH / CD SRCH / SCAN / T CALL / TX POWER REV / DW or one of the all Set mode items (except Set mode items #16 through 19; initial setting is "Set mode item #26 SCAN SKP").

Default: Depends on the transceiver version.

20 PAG CD-R

Function: Setting the Receiver Pager Code for the Enhanced CTCSS Paging & Code Squelch function

See page 7 for details.

21 PAG CD-T

Function: Setting the Transmitting Pager Code for the Enhanced CTCSS Paging & Code Squelch function.

See page 7 for details.

22 RPT SFT

Function: Sets the Repeater Shift direction.

Available Values: - RPT / + RPT / SIMPLEX

Default: SIMPLEX

23 RPT ARS

Function: Activates/Deactivates the Automatic Repeater Shift feature..

Available Values: ON / OFF

Default: ON

24 RPT FREQ

Function: Sets the magnitude of the Repeater Shift.

Available Values: 0.00 - 150.00MHz

Default: 0.60MHz

25 SCAN RSM

Function: Selects the Scan Resume mode.

Available Values: BUSY / HOLD / 2.0 SEC - 10.0 SEC (0.5 SEC step)

Default: 5.0 SEC

BUSY: The scanner will hold until the signal disappears, then will resume when the carrier drops.

HOLD: The scanner will stop when a signal is received, and will not restart.

2.0 SEC - 10.0 SEC: The scanner will hold for the selected resume time, then resume scanning, whether or not the other station is still transmitting.

26 SCAN SKP

Function: Selects the Memory Scan mode.

Available Values: SKIP / SELECT / OFF

Default: OFF

SKIP: The scanner will “skip” the flagged channels during scanning.

SELECT: The scanner will only scan channels that are flagged (Preferential Scan List).

OFF: All memory channels will be scanned (the “flag” will be ignored).

27 DW REVRT

Function: Enables/disables the “Priority Channel Revert” feature.

Available Values: ON / OFF

Default: OFF

See page 20 for details.

28 SQL TYPE

Function: Selects the Tone Encoder and/or Decoder mode.

Available Values: TONE / TSQL / DCS / RV TONE / PAGER / OFF

Default: OFF

TONE: CTCSS Encoder

TSQL: CTCSS Encoder/Decoder

Menu Selection Details

DCS: Digital Coded Encoder/Decoder

RV TONE: Reverse CTCSS Decoder (Mutes receiver when matching tone is received)

PAGER: Enhanced Paging & Code Squelch

Note: See also Set Mode Item “**32 SQL EXP**” regarding additional selections available during “Split Tone” operation.

29 TONE FRQ

Function: Setting of the CTCSS Tone Frequency.

Available Values: 50 standard CTCSS tones

Default: 100.0Hz

CTCSS TONE FREQUENCY (Hz)					
67.0	69.3	71.9	74.4	77.0	79.7
82.5	85.4	88.5	91.5	94.8	97.4
100.0	103.5	107.2	110.9	114.8	118.8
123.0	127.3	131.8	136.5	141.3	146.2
151.4	156.7	159.8	162.2	165.5	167.9
171.3	173.8	177.3	179.9	183.5	186.2
189.9	192.8	196.6	199.5	203.5	206.5
210.7	218.1	225.7	229.1	233.6	241.8
250.3	254.1	-	-	-	-

30 DCS CODE

Function: Setting of the DCS code.

Available Values: 104 standard DCS codes

Default: 023

DCS CODE									
023	025	026	031	032	036	043	047	051	053
054	065	071	072	073	074	114	115	116	122
125	131	132	134	143	145	152	155	156	162
165	172	174	205	212	223	225	226	243	244
245	246	251	252	255	261	263	265	266	271
274	306	311	315	325	331	332	343	346	351
356	364	365	371	411	412	413	423	431	432
445	446	452	454	455	462	464	465	466	503
506	516	523	526	532	546	565	606	612	624
627	631	632	654	662	664	703	712	723	731
732	734	743	754	-	-	-	-	-	-

31 DCS INV

Function: Select a combination of DCS inversion codes in terms of communication direction.

Available Values: NORMAL / INVERT / BOTH

Default: NORMAL

NORMAL: Homeomorphic

INVERT: Inverted Phase

BOTH: Both Phase

32 SQL EXP

Function: Enables/Disables the split CTCSS/DCS coding.

Available Values: ON / OFF

Default: OFF

When this Set Mode Item is set to “ON”, the following additional parameters are available after the “PAGER” parameter when configuring Set Mode Item “28 SQL TYPE”:

D CODE: DCS Encode only.

T DCS: Encodes a CTCSS tone and Decodes a DCS code.

D TONE: Encodes a DCS code and Decodes a CTCSS tone.

33 SQL RF

Function: Adjusts the RF Squelch threshold level.

Available Values: S1 - S8 / OFF

Default: OFF

34 TS MUTE

Function: Enables/Disables the receiver audio output while the Tone Search or DCS Search Scanner is activated.

Available Values: ON / OFF

Default: ON

35 TS SPEED

Function: Selects the Tone Search or DCS Search Scanner speed.

Available Values: FAST / SLOW

Default: FAST

36 LOCK

Function: Selects the Control Locking Lockout combination.

Available Values: KEY+DIAL / PTT / KEY+PTT / DIAL+PTT / ALL / KEY / DIAL

Default: KEY+DIAL

37 STEP

Function: Sets the frequency synthesizer steps.

Available Values: AUTO / 5 / 6.25 / 10 / 12.5 / 15 / 20 / 25 / 50 / 100 (kHz)

Default: AUTO

38 TOT

Function: Sets the Time-Out Timer..

Available Values: 0.5 MIN - 10.0 MIN (0.5 MIN step) / OFF

Default: 3.0 MIN

The time-out timer shuts off the transmitter after continuous transmission of the programmed time.

39 TEMP

Function: Indicates the current temperature inside the transceiver.

40 VOLT

Function: Indicates the DC Supply Voltage.

41 VER DISP

Function: Displays the transceiver software version.

Available Values: CPU

42 WIDTH

Function: Reduction of the Microphone Gain/Deviation and receiver bandwidth.

Available Values: WIDE / NARROW

Default: WIDE

Menu Selection Details

43 WX ALERT

Function: Enables/Disables the Weather Alert feature.

Available Values: ON / OFF

Default: OFF

ON: The weather alert will be received

OFF: The weather alert will not be received

44 WX VOL

Function: Selects the audio output level of the Weather Alert.

Available Values: NOR VOL / MAX VOL

Default: NOR VOL



Copyright 2024
YAESU MUSEN CO., LTD.
All rights reserved.

No portion of this manual may be
reproduced without the permission of
YAESU MUSEN CO., LTD.

YAESU MUSEN CO., LTD.

Omori Bellport Building D-3F
6-26-3 Minami-Oi, Shinagawa-ku, Tokyo, 140-0013, Japan

YAESU USA

6125 Phyllis Drive, Cypress, CA 90630, U.S.A.

YAESU UK

Unit 4, Concorde Park, Concorde Way, Segensworth North,
Fareham, Hampshire PO15 5FG, United Kingdom