



## ADVANCED INSTRUCTIONS

HF/VHF/UHF ALL MODE TRANSCEIVER

# IC-7100

## INTRODUCTION

1 PANEL DESCRIPTION

2 INSTALLATION AND CONNECTIONS

3 BASIC OPERATION

4 RECEIVE AND TRANSMIT

5 FUNCTIONS FOR RECEIVE

6 FUNCTIONS FOR TRANSMIT

7 D-STAR INTRODUCTION

8 D-STAR OPERATION <BASIC>

9 D-STAR OPERATION <ADVANCED>

10 GPS/GPS-A OPERATION

11 MEMORY OPERATION

12 SCAN OPERATION

13 USING AN SD CARD

14 VOICE MEMORY FUNCTION

15 VOICE TX FUNCTION

16 ANTENNA TUNER OPERATION

17 SET MODE

18 DATA COMMUNICATION

19 MAINTENANCE

20 CONTROL COMMAND

21 SPECIFICATIONS AND OPTIONS

# INTRODUCTION

## About these Advanced Instructions (PDF format)

These Advanced Instructions describe the details of the IC-7100 features. This PDF formatted manual provides you with convenient functions, as follows.

**NOTE:** Below page is used only as an example to describe these advanced instructions.

### Move to the previously read page.

Click **Previous view** at the left top on an each page, to move back to the previously read page.

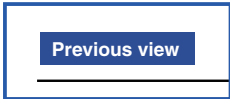

The location of the keys used in the described steps are illustrated. Example: Push **SET**(**C**).

### Shows a term description

When the mouse cursor is moved over a term which is highlighted in yellow, the description of the term is displayed.

/// If the "Beep Level" item is set to "0," the Band

### Moves to the page, if clicked.

(p. 17-18)

3 BASIC OPERATION

Setting frequency (Continued)

◆ **Band edge warning beep**  
You can hear a beep tone when you tune into or out of an amateur band's frequency range. A regular beep sounds when you tune into a range, and a lower tone error beep sounds when you tune out of a range.

- Push **SET**(**C**) to enter the Set mode.
- Touch the "Band Edge Beep" item of the "Function" Set mode.  
Function > **Band Edge Beep**  
• If the specified item is not displayed, touch **▲** or **▼**(**D**) one or more times to select the page.
- Touch the desired option to select the desired band edge warning beep setting, or to turn OFF the function.  
• OFF: Band edge beep is OFF.  
• ON (Default): When you tune into or out of the default amateur band's frequency range, a beep sounds. (default)  
• ON (User): When you tune into or out of a user programmed amateur band's frequency range, a beep sounds.  
• ON (User) & TX Limit: When you tune into or out of a user programmed amateur band's frequency range, a beep sounds. Also transmission is inhibited outside the programmed range.  
• If desired, touch the item for 1 second to open the Default set window, then select the "Default" to reset to the default setting.
- Push **SET**(**C**) to exit the Set mode.

/// If the "Beep Level" item is set to "0," the Band edge beep does not sound. The beep output level can be set in the "Beep Level" item of the "Function" Set mode. (p. 17-18)

**About the user band edge frequencies**  
When "ON (User)" or "ON (User) & TX Limit" is selected in the "Band Edge Beep" item, a total of 30 band edge frequencies can be programmed in the "User Band Edge" item. See the next page for details.  
If "OFF" or "ON (Default)" is selected, the "User Band Edge" item does not appear in the "Function" Set mode.

3-13

The screen shots at the right column, correspond to the operating instructions and procedures shows both setting and operating example.

The location of the keys used in the described steps in the left column are illustrated.

# INTRODUCTION

## Functions and features of Adobe® Reader®

The following functions and features can be used with Adobe® Reader®.

### • Keyword search

Click “Find (Ctrl+F)” or “Advanced Search (Shift+Ctrl+F)” in the Edit menu to open the search screen. This is convenient when searching for a particular word or phrase in this manual.

\*The menu screen may differ, depending on the Adobe® Reader® version.

Click to open the find or search screen or advanced search screen.

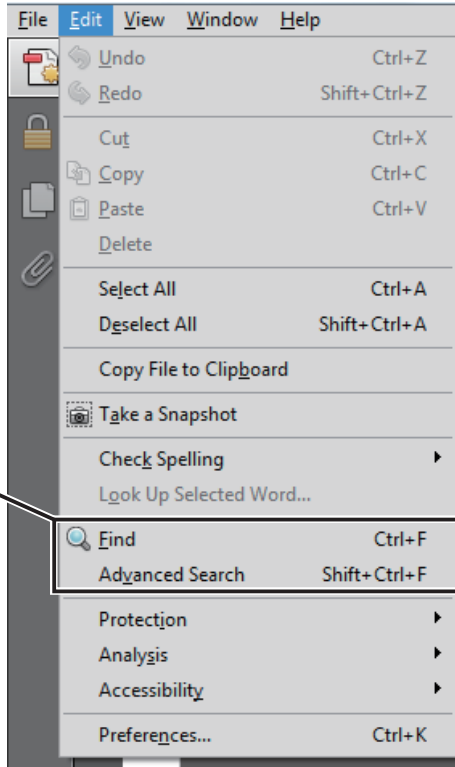

### • Find screen

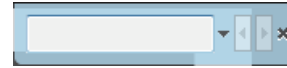

### • Advanced search screen

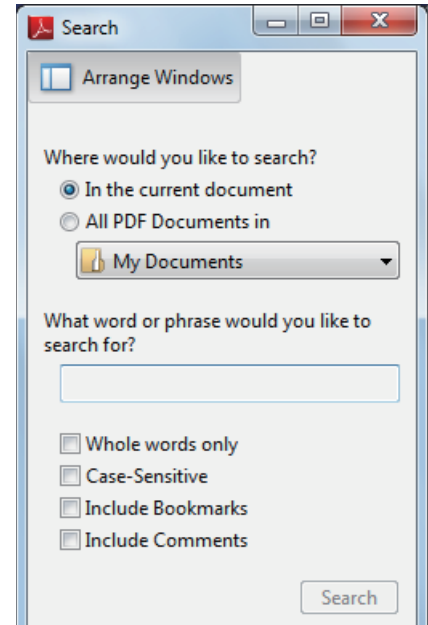

### • Printing out the desired pages.

Click “Print (P)” in File menu, and then select the paper size and page numbers you want to print.

\*The printing setup may differ, depending on the printer. Refer to your printer’s instruction manual for details.

\*Select "A4" size to print out the page in the equal-sized size.

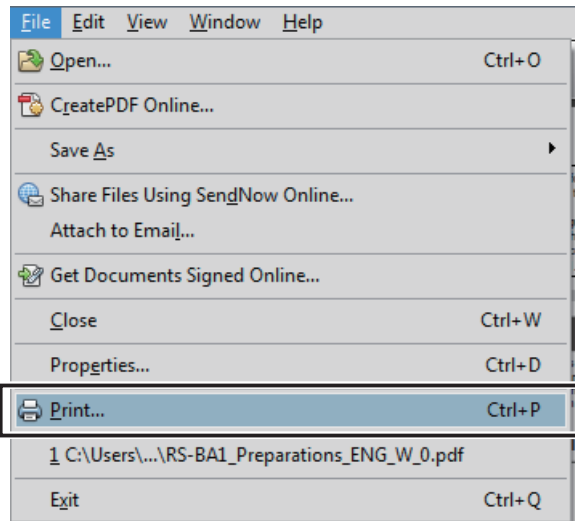

### • Read Out Loud feature.

The Read Out Loud feature reads aloud the text in this Instruction Manual.

Refer to the Adobe® Reader® Help for the details. (This feature may not be usable, depending on your PC environment including the operating system.)

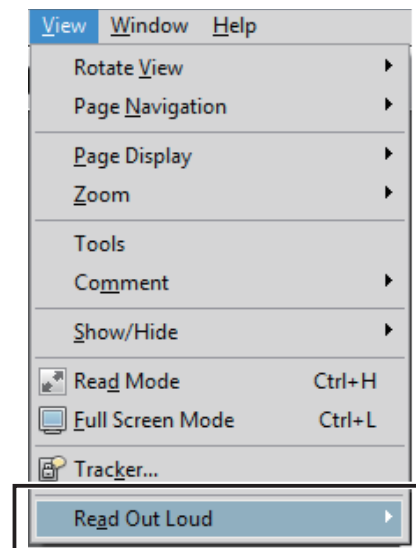

\*The screen may differ, depending on the Adobe® Reader® version.

# INTRODUCTION

## About the touch screen

The following functions and features can be used with Adobe® Reader®.

### Touch operation

#### ◇ A brief touch

If the monitor is touched briefly, a beep sounds.

#### ◇ Touch for 1 second

If the monitor is touched for more than 1 second, a beep sounds.

- The operation is enabled as the beep sounds.

#### ◇ Touch screen precautions

Briefly touching the controller's touch operates the function.

- The touch screen may not properly work when LCD protection film or sheet is attached.
- Touching the screen with finger nails, sharp topped object and so on, or touching the screen hard may damage the screen.
- Tablet PC's operations such as flick input, pinch in and pinch out cannot be performed with this touch screen.

### What to touch

The following functions can be touched to operate.

- See each function's instructions for further details.

#### ◇ Touch screen maintenance

- If the touch screen becomes dusty or dirty, wipe it clean with a soft, dry cloth.
- When you wipe the touch screen, be careful not to push it too hard or scratch it with finger nails. Otherwise you may damage the touch screen.

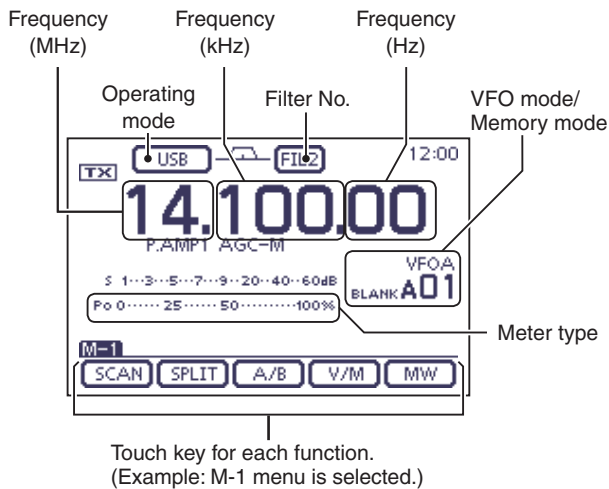



<b>Controller — Front panel .....</b>	<b>1-2</b>
<b>Controller — Function display .....</b>	<b>1-8</b>
<b>Controller — Multi-function keys .....</b>	<b>1-11</b>
◇ M-1 (M-1 menu) Display .....	1-11
◇ M-2 (M-2 menu) Display .....	1-11
◇ M-3 (M-3 menu) Display .....	1-11
◇ D-1 (D-1 menu) Display .....	1-11
◇ D-2 (D-2 menu) Display .....	1-11
◇ Function keys on M-1 display .....	1-12
◇ Function keys on M-2 display .....	1-12
◇ Function keys on M-3 display .....	1-13
◇ Function keys on D-1 display .....	1-14
◇ Function keys on D-2 display .....	1-14
<b>Controller — Rear and bottom panels .....</b>	<b>1-15</b>
<b>Main unit — Front panel .....</b>	<b>1-16</b>
<b>Main unit — Rear panel .....</b>	<b>1-17</b>
◇ ACC socket information .....	1-19
◇ DATA2 socket information .....	1-20
◇ Microphone connector information .....	1-20
<b>Microphone .....</b>	<b>1-21</b>
◇ HM-198 (Supplied) .....	1-21
◇ SM-50 (Option) .....	1-22
◇ SM-30 (Option) .....	1-22
◇ HM-151 (Option) .....	1-23

## Controller — Front panel



### 1 POWER SWITCH•AF VOLUME [PWR]•[AF]

(p. 3-2)

- ➔ Push to turn ON the transceiver power.
  - First, confirm the DC power source is turned ON.
- ➔ Hold down for 1 second to turn OFF the power.
- ➔ Rotate to adjust the audio output level.

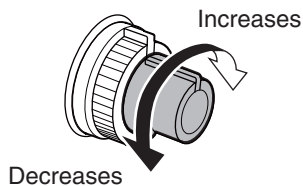

### 2 RF GAIN CONTROL/ SQUELCH CONTROL

[RF/SQL] (p. 3-19)

Rotate to adjust the RF gain and squelch threshold levels.

The squelch removes noise output to the speaker when no signal is received. (closed condition)



- The squelch is particularly effective for AM and FM, but also works in other modes.
- The 12 to 1 o'clock position is recommended for the most effective use of the [RF/SQL] control.
- [RF/SQL] operates as only an RF gain control in SSB, CW and RTTY (Squelch is fixed open), or a squelch control in AM, FM, WFM and DV (RF gain is fixed at maximum sensitivity), when "Auto" is selected as the "RF/SQL Control" item in the "Function" Set mode. (p. 17-18)

[SET] > Function > **RF/SQL Control**

#### • When used as an RF gain/squelch control

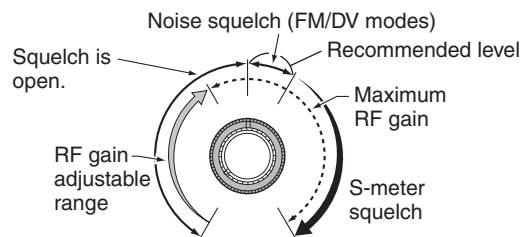

#### • When used as an RF gain control

(Squelch is fixed open; SSB, CW and RTTY only)

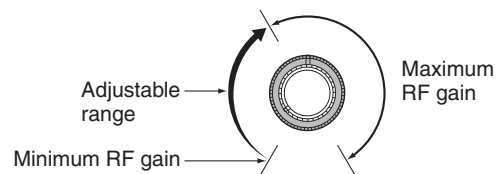

While rotating the RF gain control, a faint noise may be heard. This comes from the **DSP** unit and does not indicate an equipment malfunction.

#### • When used as a squelch control

(RF gain is fixed at maximum.)

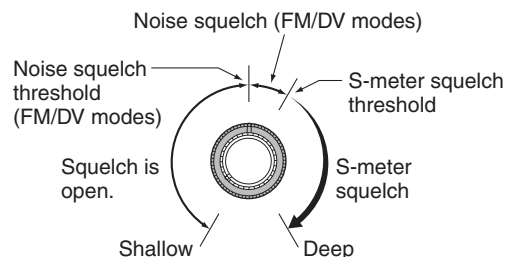

Controller — Front panel (Continued)



**3 TX/RX LED**

- Lights green when the squelch opens, or a signal is received.
- Lights red when transmitting.

**4 MEMORY BANK CONTROL [BANK]⊙**

- When both the **PBT** and RIT LEDs are OFF  
Rotate to select a Memory bank.
- When the PBT LED (6) lights green  
**(Mode: SSB/CW/RTTY/AM)**  
Rotate to adjust the receiver's IF **filter** passband width using the **DSP** circuit.
- When the RIT LED (7) lights orange  
Disable this control.

**5 M-CH CONTROL•CLEAR SWITCH [M-CH]•[CLR]⊙**

- Push to select the action of the [M-CH/BANK]⊙ controls as the Memory/Bank selection, PBT control or RIT control.
- When the both RIT and PBT LEDs are OFF  
Rotate to select a Memory channel.
- When the RIT LED lights orange
  - Rotate to adjust the RIT frequency shift.
    - The frequency shift range is ±9.99 kHz in 10 Hz steps. The control tunes in 1 Hz steps when the operating frequency readout is set to the 1 Hz step.
  - Hold down for 1 second to clear the RIT shift frequency.

**✓ What is the RIT function?**

The RIT (Receiver Incremental Tuning) shifts the receive frequency without shifting the transmit frequency. This is useful for fine tuning stations calling you off-frequency, or when you prefer to listen to slightly different-sounding voice characteristics.

- When the PBT LED lights green  
**(Mode: SSB/CW/RTTY/AM)**
  - Rotate to adjust the receiver's IF filter passband width using the DSP circuit.
  - Hold down for 1 second to reset the PBT settings.
    - The PBT is adjustable in 50 Hz steps in the SSB/CW/RTTY modes, and 200 Hz in the AM mode. At that time, the shift value changes in 25 Hz steps in the SSB/CW/RTTY modes, and 100 Hz in the AM mode.
    - The PBT controls function as an IF shift control.

**✓ What is the PBT control?**

The PBT function electronically modifies the IF passband width to reject interference. This transceiver uses the DSP circuit for the PBT function.

**6 PBT LED**

- Lights green when the [M-CH/BANK]⊙ controls act as the PBT control.
  - Push the [M-CH]⊙ switch to select PBT control.

**7 RIT LED**

- Lights orange when the RIT function is turned ON.
- Lights orange when the [M-CH/BANK]⊙ controls act as the RIT control.
  - Push the [M-CH]⊙ switch to select RIT control.
  - The RIT control is the inner control. The outer control is disabled.

**8 RIT KEY [RIT] (p. 5-4)**

- Push to turn the RIT function ON or OFF.
  - Use the [M-CH]⊙ control to vary the RIT frequency.
- Hold down for 1 second to add the shift frequency of the RIT function to, or subtract it from, the displayed frequency.

Controller — Front panel (Continued)



**9 ANTENNA TUNER/CALL KEY** [TUNER/CALL]

- ANTENNA TUNER KEY Operation (p. 16-4)  
**(Frequency band: HF/50 MHz)**
  - ➔ Push to turn an optional automatic antenna tuner ON or OFF (bypass).
  - ➔ Hold down for 1 second to manually tune the antenna tuner.
    - If the tuner cannot tune the antenna within 20 seconds, the tuning circuit is automatically bypassed.
- CALL KEY Operation (p. 11-4)  
**(Frequency band: 144/430 MHz)**  
 Push to select the Call channel.

In the 70 MHz band, push to sound an error beep.

**10 MENU KEY** [MENU] (p. 1-11)

- Push to change the set of functions assigned to the touch keys.
- Toggles the function display menu between M-1, M-2 and M-3 menus or D-1 and D-2 menus.

**11 MIC GAIN/RF POWER ADJUSTMENT KEY**

[MIC/RF PWR] (p. 3-24)  
 Push to open the MIC gain/RF power adjustment display.

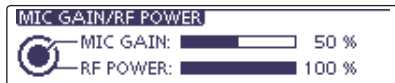

- Rotate [M-CH] to adjust the MIC gain.
- Rotate [BANK] to adjust the RF power.

Frequency band	RF output power range	
HF/50 MHz	2 to 100 W	(AM: 1 to 30 W)
70 MHz*	2 to 50 W	(AM: 1 to 15 W)
144 MHz	2 to 50 W	
430 MHz	2 to 35 W	

- Push again to close the window.

**12 NOISE BLANKER KEY** [NB] (p. 5-8)  
**(Mode: SSB/CW/RTTY/AM)**

- ➔ Push to turn the noise blanker ON or OFF.  
 The noise blanker reduces pulse-type noise such as that generated by vehicle ignition systems. The noise blanker is not effective for non-pulse-type noise.
  - “NB” appears when the noise blanker is ON.
- ➔ Hold down for 1 second to display the “NB” screen. Push to return to the previous screen.

**13 KEY SPEED/CW PITCH ADJUSTMENT KEY**

[SPEED/PITCH] (pp. 4-4, 6-4)  
 Push to open the Key speed/CW pitch adjustment display.



- Rotate [M-CH] to adjust the keying speed of the internal electronic CW keyer to between 6 wpm (minimum) and 48 wpm (maximum).
- Rotate [BANK] to shift the received CW audio pitch and the CW sidetone pitch without changing the operating frequency.
- The CW pitch can be adjusted from 300 to 900 Hz in approximately 5 Hz steps.
- Push again to close the window.

**14 NOISE REDUCTION KEY** [NR] (p. 5-9)

- ➔ Push to turn DSP noise reduction ON or OFF.
  - “NR” appears when noise reduction is ON.
- ➔ Hold down for 1 second to display the “NR” screen. Push to return to the previous screen.
  - Rotate the Dial to adjust the DSP noise reduction level. Set for maximum readability.

\* 70 MHz band transmission is available, depending on the transceiver version.

Controller — Front panel (Continued)



**15 PREAMP•ATTENUATOR KEY** P.AMP/ATT

- PREAMP KEY Operation (p. 5-2)  
**(Frequency band: HF, 50/70 MHz)**  
 Push to select one of two receive RF preamplifiers, or to bypass them.
  - “P. AMP1” is a wide dynamic range preamplifier. It is most effective for the 1.8 to 21 MHz bands.
  - “P. AMP2” is a high-gain preamplifier. It is most effective for the 24 to 70 MHz bands.
  - No indicator appears when the preamplifiers are not selected.

**✓ What is the preamplifier?**

The preamplifier amplifies signals in the front end to improve the S/N ratio and sensitivity. Select “P. AMP1” or “P. AMP2” when receiving weak signals.

**(Frequency band: 144/430 MHz)**

Push to turn the preamplifier ON or OFF.  
 • “P.AMP” appears when the preamplifier is ON.

- ATTENUATOR KEY Operation (p. 5-2)
  - Hold down for 1 second to turn ON the attenuator.
    - “ATT” appears when the attenuator is ON.
  - Push to turn OFF the attenuator.
    - “ATT” disappears.

**✓ What is the attenuator?**

The attenuator prevents a desired signal from being distorted when very strong signals are near it, or when very strong electromagnetic fields, such as from a broadcasting station, are near your location.

**16 NOTCH KEY** NOTCH (p. 5-10)

**(Mode = Auto notch: SSB/AM/FM  
 Manual notch: SSB/CW/RTTY/AM)**

- In the SSB and AM modes, push to toggle the notch function between auto, manual and OFF.
  - Either the Auto or Manual notch function can be turned OFF in the “[NOTCH] Switch (SSB)/(AM)” items of the “Function” Set mode. (p. 17-21)  
 [SET] > Function > [NOTCH] Switch (SSB)  
 [SET] > Function > [NOTCH] Switch (AM)
- In the FM mode, push to turn the Auto Notch function ON or OFF.
- In the CW or RTTY mode, push to turn the Manual Notch function ON or OFF.
  - “MN” appears when the Manual Notch function is ON.
  - “AN” appears when the Auto Notch function is ON.
  - No indicator appears when the notch filter is OFF.
- Hold down for 1 second to display the “NOTCH” screen.  
 Push to return to the previous screen.
  - Rotate the Dial to adjust the notch frequency to reject an interfering signal when the manual function is ON.
  - Notch filter center frequency:  
 SSB/RTTY: –1040 Hz to +4040 Hz  
 CW: CW pitch frequency –2540 Hz to  
 CW pitch frequency +2540 Hz  
 AM: –5060 Hz to +5100 Hz

**✓ What is the notch filter?**

The notch filter is a narrow filter that eliminates unwanted CW or AM carrier tones, while preserving the desired voice signal. The DSP circuit automatically adjusts the notch frequency to effectively eliminate unwanted tones.

Controller — Front panel (Continued)



**17 DR MODE KEY [DR]** (section 7,8,9)

- ➔ Push to select the DR mode.
  - When the DR mode is selected, the transceiver automatically selects the DV mode.
- ➔ In the DR mode, push to cancel it.
  - The transceiver returns to the previous screen before entering the DR mode.

**18 SET MODE KEY [SET]** (section 17)

- ➔ Push to enter or exit the SET mode.
  - “Voice Memo,” “Call Sign,” “RX History,” “DV Memory,” “My Station,” “DV Set,” “GPS,” “SPEECH,” “QSO/RX Log,” “Function,” “Tone Control,” “Connectors,” “Display,” “Time Set,” “SD Card” and “Others” set group are selectable.

**19 QUICK MENU KEY [QUICK]**

- ➔ Push to open or close the Quick Menu window.
  - The Quick Menu is used to quickly select various functions.
- ➔ In the setting screen, push to open the Default set window.
  - Touch “Default” to reset to the default setting.

**20 AUTO TUNE•RX→CS KEY [AUTO TUNE(RX-CS)]**

- AUTO TUNE KEY Operation (p. 4-5)  
**(Mode: CW)**
  - ➔ Push to automatically adjust for a zero beat with the received signal. Zero beat means that two signals are exactly the same frequency.
    - “AUTO TUNE” blinks when the auto tune function is activated.
    - When the RIT function is ON, the auto tune function changes the RIT frequency, not the displayed frequency.

- RX CALL SIGN CAPTURE KEY Operation (p. 8-7)  
**(Mode: DV, when the DR mode is selected)**
  - ➔ Push to open the “RX>CS” screen. Push again to return to the previous screen.
  - ➔ Hold down for 1 second to set the received **call signs** (station and repeaters) as the operating call sign.

**21 TRANSMIT FREQUENCY CHECK KEY [XFC]**

- ➔ During split frequency or repeater operation, hold down to listen to the transmit frequency. (p. 4-28)
  - While holding down this switch, the transmit frequency can be changed with the Dial or [MPAD].
  - When the Split Lock function is turned ON in the Split operation, hold down [XFC] to cancel the Dial lock function. (p. 6-10)
- ➔ When operating simplex, hold down to monitor the frequency.
  - While holding down this key, the squelch is open and the interference reject functions are temporarily turned OFF.
- ➔ When operating simplex and the RIT function is turned ON, hold down to listen to the transmit frequency. The frequency is the same as when the RIT is OFF.
- ➔ In the DV mode, hold down this key to select the RX monitoring mode. (p. 17-13)



Controller — Front panel (Continued)



**22 SPEECH•LOCK KEY** [SPEECH] (p. 3-20)

- **SPEECH KEY Operation** (p. 3-20)  
Push to audibly announce the S-meter level, the displayed frequency and the operating mode.
  - The S-Level announcement can be turned OFF in the “S-Level SPEECH” item of the “SPEECH” Set mode. (p. 17-15)  
[SET] > SPEECH > **S-Level SPEECH**
  - When RIT is ON, the RIT offset is not included in the frequency announcement.

- **LOCK KEY Operation** (p. 5-12)  
Hold down for 1 second to turn the Lock function ON or OFF.
  - The function electronically locks the Dial.
  - “[LOCK]” appears when the function is ON.
  - You can select the Dial lock and Panel lock in the “Lock Function” item of the “Function” Set mode. (p. 17-20)  
[SET] > Function > **Lock Function**

**NOTE:** The [SPEECH/LOCK] key operation to activate the voice synthesizer or the Lock functions can be replaced in the “[SPEECH/LOCK] Switch” item of the “Function” Set mode. (p. 17-20)  
[SET] > Function > **Lock Function**

**23 MEMO PAD KEY** [MPAD] (p. 11-13)

- ➔ Push to sequentially call up the contents from the memo pad.  
The 5 (or 10) most recently programmed frequencies and operating modes can be recalled, starting from the most recent.
  - The memo pad capacity can be increased from 5 to 10 in the “Memopad Numbers” item of the “Function” Set mode (p. 17-20)  
[SET] > Function > **Memopad Numbers**
- ➔ Hold down for 1 second to write the displayed data into a memo pad.
  - The 5 most recent entries remain in the memo pad.

**24 MAIN DIAL**

Rotate to change the displayed frequency, select the Set mode settings, and so on.

**25 MAIN DIAL TENSION LATCH**

Select the Dial drag.  
• Three positions are selectable. The top setting turns on clicks as the dial is turned.

## Controller — Function display

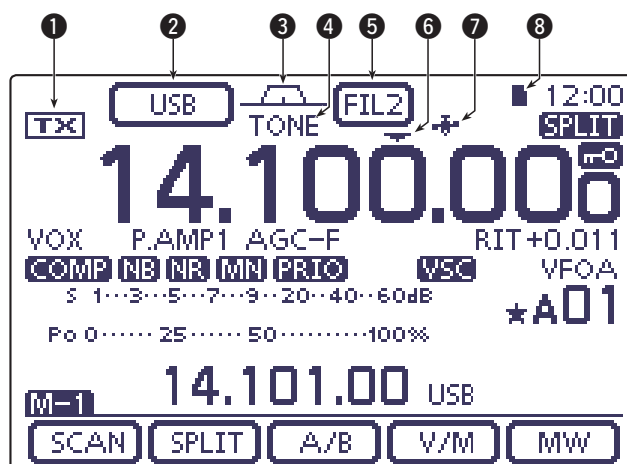

### 1 TX ICON

Indicates either the displayed frequency can be transmitted, or not.

- ➔ “TX” appears while the operating frequency is in an amateur band.
- ➔ “TX” appears while the operating frequency is not in an amateur band. However, when the “Band Edge Beep” item is set to “OFF” in the “Function” Set mode (p. 17-18), “TX” does not appear.
- ➔ [SET] > Function > **Band Edge Beep**
- ➔ “LMT” appears while the output power is decreased because the Power FET’s temperature is high.
- ➔ “HOT” appears while transmission is inhibited because the Power FET’s temperature is too high.

### 2 MODE ICONS (p. 3-17)

- ➔ Displays the selected operating mode.
  - “-D” appears when SSB data, AM data or FM data mode is selected.
- ➔ Touch to enter the Mode selection screen.
  - On the Mode selection screen, touch the block to select the operating mode.

### 3 PASSBAND WIDTH ICON (pp. 5-5, 5-6)

Graphically displays the passband width for twin PBT operation and the center frequency for **IF shift** operation.

### 4 TONE SQUELCH/DIGITAL SQUELCH ICONS

(Mode: FM)

- ➔ “TONE” appears when the repeater tone function is ON. (p. 4-25)
- ➔ “TSQL” appears when the **tone squelch function** is ON. (p. 4-22)
- ➔ “DTCS” appears when the **DTCS function** is ON. (p. 4-23)

(Mode: DV)

- ➔ “DSQL” appears when the digital **call sign** squelch function is ON. (p. 9-22)
- ➔ “CSQL” appears when digital code squelch function is ON. (p. 9-22)

### 5 IF FILTER ICON (p. 5-6)

- ➔ Shows the selected IF **filter**.
- ➔ Touch to select one of three IF filter settings.
  - The selected filter passband width and shifting value are displayed for 2 seconds in the window.
- ➔ Touch for 1 second to display the “FILTER” screen to adjust the filter passband width.
- ➔ When the “FILTER” screen is displayed, touch for 1 second to return to the previous screen.

### 6 QUICK TUNING ICON (p. 3-8)

Appears when the Quick tuning mode is selected.

- When “▼” is displayed, the frequency changes in preset kHz or 1 MHz quick tuning steps.
- When “▼” is not displayed, the frequency changes in 10 Hz or 1 Hz steps.

### 7 GPS ICON (p. 10-2)

- ➔ Appears when valid position data is received from a GPS receiver that is connected to the [DATA1] jack.
- ➔ Blinks when invalid data is received from the GPS receiver.

### 8 SD CARD ICON

- ➔ “■” appears when an SD card is inserted.
- ➔ “■” and “□” alternately blinks while accessing the SD card.



Controller — Function display (Continued)

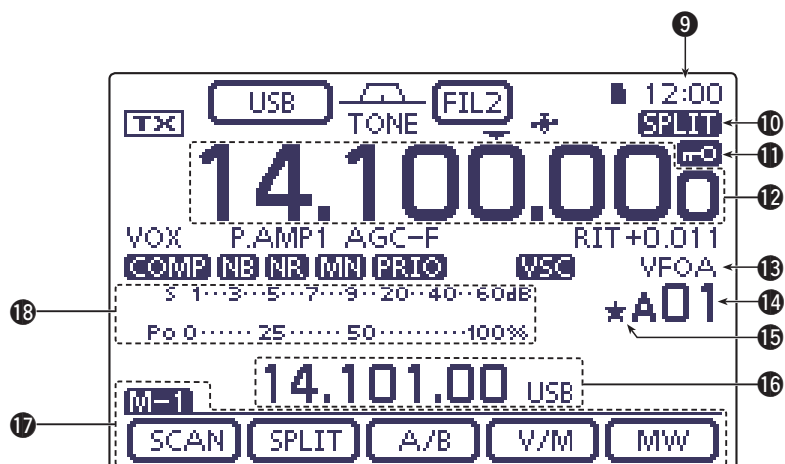

**9 CLOCK READOUT**

Shows the current time.  
 • UTC time or local time can be selected.

**10 SPLIT ICON** (p. 6-8)

“SPLIT” appears when the Split function is turned ON.

**11 LOCK ICON** (p. 5-12)

“” appears when the Lock function is activated.

**¼ TUNING DIAL SPEED ICON** (p. 3-10)  
 (Mode: SSB-D/CW/RTTY)

“” appears when the tuning dial speed is set so that one rotation is equal to ¼ of the normal rotation.  
 • This function is selectable only when the quick tuning function is turned OFF.

**12 FREQUENCY READOUTS**

- Displays the operating frequency.
- Touch the MHz digits to enter the Band selection screen.
- Touch the MHz digits for 1 second to turn the 1 MHz quick tuning mode ON or OFF.
- Touch the kHz digits to turn the preset kHz quick tuning mode ON or OFF.
- Touch the kHz digits for 1 second to enter the Tuning step selection screen.
- Touch the Hz digits to for 1 second to toggle between 10 Hz and 1 Hz steps.

**13 VFO/MEMORY ICONS** (p. 3-4)

- “VFOA” or “VFOB” appears whether VFO A or VFO B is selected.
- “MEMO” appears when the memory mode is selected.

**14 MEMORY CHANNEL READOUT** (p. 11-3)

- Shows the selected memory channel, scan edge channel or Call channel.
- Memory bank indicator (A to E) appears to the left of memory channel.
- Touch to toggle between the VFO and Memory modes.

**15 SELECT MEMORY CHANNEL ICON**

“★” appears when the selected memory channel is set as a select memory channel. (p. 12-12)

**16 INFORMATION READOUT**

Displays the transmit frequency of the Split operation, descriptions of the memory channel or Received Call sign in the DV mode, and so on.

**17 FUNCTION DISPLAY** (p. 1-11)

- Shows the function of the Touch keys.
- Push **MENU** to change the set of functions assigned to the touch keys.
- Toggles the function display menu between M-1, M-2, and M-3 menus or D-1 and D-2 menus.

**18 MULTI-FUNCTION METER INDICATION**

- Displays the signal strength while receiving.
- Displays the relative output power, SWR, ALC or compression levels while transmitting.
- When the Meter Peak Hold function is ON, the peak level of a received signal strength or the output power is displayed for approximately 0.5 seconds.
- Touch to select the RF power, SWR, ALC or Compression meter.
- Touch for 1 second to display the Multi-function meter.

## Controller — Function display (Continued)

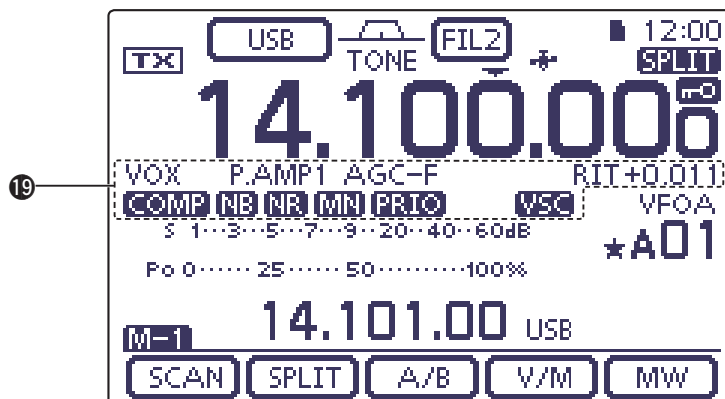
**19 FUNCTION ICONS**

- “VOX” appears when the **VOX** function is activated. (p. 6-2)
- The Break-in icons appear when the Break-in function is turned ON. (p. 6-3)
  - “F-BKIN” appears when the Full Break-in function is turned ON.
  - “BK-IN” appears when the Semi Break-in function is turned ON.
- The Preamp icons appear when a preamplifier is turned ON. (p. 5-2)
  - In the HF, 50/70 MHz frequency band, either “P.AMP1” or “P.AMP2” is displayed when preamp 1 or preamp 2 is ON.
  - In the 144/430 MHz frequency band, “P.AMP” is displayed when the preamp is ON.
- “ATT” appears when the Attenuator function is turned ON. (p. 5-2)
- The **AGC** icons display the selected AGC time constant. (p. 5-3)
  - “AGC-F” for AGC fast; “AGC-M” for AGC mid; “AGC-S” for AGC slow; “AGC-OFF” for AGC OFF.
  - In the FM, WFM and DV mode, “AGC-F” for AGC fast is fixed.
- “DUP+” appears when plus **duplex**, “DUP -” appears when minus duplex (**repeater**) operation is selected. (p. 4-25)
- “RIT” and the shift frequency are displayed when the RIT function is turned ON. (p. 5-4)
- “**COMP**” appears when the Speech Compressor function is turned ON.
- “**NB**” appears when the Noise Blanker function is turned ON. (p. 5-8)
- “**NB**” appears when the Noise Reduction function is turned ON. (p. 5-9)

- The Notch icons appear when the **Notch filter** function is turned ON. (p. 5-10)

**(Mode: SSB/CW/RTTY/AM)**

- “**MN**” appears when the Manual Notch function is turned ON.

**(Mode: SSB/AM/FM)**

- “**AN**” appears when the Automatic Notch function is turned ON.

- “**PRIO**” appears when priority scan is turned ON. (p. 12-16)

- “**VSC**” appears when the VSC (Voice Squelch Control) function is turned ON.

**(Mode: DV)**

- “**EMR**” appears when the EMR (Enhanced Monitor Receive) communication mode is selected. (p. 9-10)

- In the EMR communication mode, no **call sign** setting is necessary when operating in the DV mode.

- “**EMR**” blinks when receiving an EMR signal.

- “**BK**” appears when the BK (Break-in) function is turned ON. (p. 9-9)

- The BK function allows you to break into a conversation where the two other stations are communicating with call sign squelch enabled.

- “**BK**” blinks when receiving a break-in call.

## Controller — Multi-function keys

- Push **[MENU]** to change the set of functions assigned to touch keys.
  - Toggles the function display menu between M-1, M-2 and M-3 menus or D-1 and D-2 menus.
  - Functions vary, depending on the operating mode.
  - In the DR mode, the D-1 and D-2 menus can be selected.
- Touch or touch for 1 second to select the displayed functions.

### ◇ M-1 (M-1 menu) Display



### ◇ M-2 (M-2 menu) Display

(Mode: SSB)



(Mode: SSB-D)



(Mode: CW)



(Mode: RTTY)



(Mode: AM/AM-D)



(Mode: FM/FM-D/WFM)



(Mode: DV)



### ◇ M-3 (M-3 menu) Display

(Mode: SSB/AM/AM-D)



(Mode: SSB-D/RTTY)



(Mode: CW)



(Mode: FM/FM-D/WFM/DV)



### ◇ D-1 (D-1 menu) Display

(Mode: DV, when the DR mode is selected)



### ◇ D-2 (D-2 menu) Display

(Mode: DV, when the DR mode is selected)



Controller — Multi-function keys (Continued)

◇ Function keys on M-1 display

**SCAN KEY [SCAN]** (p. 12-4)

- ➔ Touch to display the “SCAN” screen.
- Push **[MENU]** to return to the previous screen.

**SPLIT KEY [SPLIT]** (p. 6-8)

- ➔ Touch to turn the split function ON or OFF.
  - “**SPLIT**” appears when the split function is ON.
- ➔ Touch for 1 second to activate the quick split function.
  - The transmit frequency shifts from the receive frequency according to the “SPLIT Offset” option in the “Function” Set mode. (p. 17-19)
  - [SET]** > Function > SPLIT/DUP > **SPLIT Offset**
- The quick split function can be turned OFF in the “Quick SPLIT” item of the “Function” Set mode. (p. 17-19)
- [SET]** > Function > SPLIT/DUP > **Quick SPLIT**

**VFO SELECT KEY [A/B]** (p. 3-5)

- ➔ Touch to select either VFO A or VFO B.
- ➔ Touch for 1 second to equalize the undisplayed VFO settings to that of the displayed VFO.

**VFO/MEMORY KEY [V/M]**

- ➔ Touch to switch between the VFO and memory modes. (p. 3-4)
  - Touching Memory channel also selects the VFO or memory modes.
- ➔ Touch for 1 second to copy the memory contents to the displayed VFO. (p. 11-9)

**MEMORY WRITE KEY [MW]** (p. 11-5)

- ➔ Touch for 1 second to store VFO data into the selected memory channel.
- This can be done in both the VFO and memory modes.

◇ Function keys on M-2 display

**DUPLEX KEY [DUP]** (p. 4-27)

- ➔ Touch to select the **duplex** direction, or to turn OFF the function.
  - “DUP-” or “DUP+” is displayed during duplex operation.
- ➔ In the FM mode, touch for 1 second to turn the one-touch **repeater** function ON or OFF.

**AGC KEY [AGC]** (p. 5-3)

(Mode: SSB/SSB-D/CW/RTTY/AM/AM-D)

- ➔ Touch to select the time constant of the AGC circuit.
- ➔ Touch for 1 second to display the “AGC” screen.
  - Push **[MENU]** to return to the previous screen.

**STONE SQUELCH KEY [TONE]** (p. 4-24)

(Mode: FM)

- ➔ Touch to select a tone function between subaudible (repeater) tone, tone squelch and **DTCS**.
- ➔ Touch for 1 second to display the “TONE” screen of the selected tone function.
  - Push **[MENU]** to return to the previous screen.

**DIGITAL SQUELCH KEY [DSQL]** (p. 9-22)

(Mode: DV)

- ➔ Touch to select a digital squelch function between digital **call sign** squelch and digital code squelch.
- ➔ Touch for 1 second to display the “DSQL” screen (digital squelch).
  - Push **[MENU]** to return to the previous screen.

**VOICE RECORDER KEY [VOICE]** (p. 15-2)

(Mode: SSB/AM/FM/DV)

This function requires to insert an SD card.

- ➔ Touch to display the “VOICE TX” screen or the “VOICE” (Root) screen, depending on the “VOICE 1st Menu” option in the “Function” Set mode (p. 17-21).

**[SET]** > Function > **VOICE 1st Menu**

- Push **[MENU]** to return to the previous screen.

**MEMORY KEYS KEY [KEYER]** (p. 4-6)

(Mode: CW)

- ➔ Touch to display the “KEYER SEND” screen or the “KEYER” (Root) screen, depending on the “KEYER 1st Menu” option in the “Function” Set mode (p. 17-21).

**[SET]** > Function > **KEYER 1st Menu**

- Push **[MENU]** to return to the previous screen.

Controller — Multi-function keys (Continued)

◇ Function keys on M-2 display (Continued)

**RTTY DECODER KEY [DEC]** (p. 4-12)

**DEC** Touch to display the RTTY Decoder screen.  
 • Push **MENU** to return to the previous screen.

**SPEECH COMPRESSOR KEY [COMP]** (p. 6-5)

(Mode: SSB)

**COMP** ➔ Touch to turn the speech compressor function ON or OFF.  
 • “**COMP**” is displayed when the speech compressor is ON.  
 ➔ Touch for 1 second to display the “COMP” screen.  
 • Push **MENU** to return to the previous screen.

**RTTY SET KEY [RTTY]** (p. 6-5)

**RTTY** Touch to display the “RTTY SET” screen.  
 • Push **MENU** to return to the previous screen.

**CALL SIGN KEY [CS]** (p. 4-13)

(Mode: DV)

**CS** Touch to display the “CALL SIGN” screen.  
 • The current **call sign** for DV operation appears.  
 • Push **MENU** to return to the previous screen.

**TRANSMISSION BANDWIDTH KEY [TBW]** (p. 6-6)

(Mode: SSB)

**TBW** ➔ Touch to display the selected transmission **bandwidth**.  
 ➔ Touch for 1 second to select the transmission bandwidth.  
 • Bandwidth is selectable from wide (WIDE), mid (MID) and narrow (NAR).

**1/4 TUNING FUNCTION KEY [1/4]** (p. 3-10)

(Mode: SSB-D/CW/RTTY)

**1/4** Touch to turn the 1/4 Tuning function ON or OFF.  
 • “**1/4**” is displayed when the 1/4 Tuning function is ON.

**CALL RECORD KEY [CD]** (p. 9-7)

(Mode: DV)

**CD** Touch to display the “RX HISTORY” screen.  
 • The call record channel appears. (RX01 to RX20)  
 • Push **MENU** to return to the previous screen.

◇ Function keys on M-3 display

**MEMORY NAME KEY [MEMO]** (p. 11-10)

**MEMO** Touch to display the “MEMO” (Memory menu) screen.  
 • Push **MENU** to return to the previous screen.

**BAND SCOPE FUNCTION KEY [SCOPE]** (p. 5-14)

**SCOPE** Touch to display the “SCOPE” (Band scope) screen.

**SWR GRAPH FUNCTION KEY [SWR]** (p. 6-13)

**SWR** Touch to display the “SWR” screen.  
 • Push **MENU** to return to the previous screen.

**DTMF MODE KEY [DTMF]** (p. 6-17)

(Mode: FM/FM-D/DV)

**DTMF** Touch to display the “**DTMF**” screen.  
 • Push **MENU** to return to the previous screen.

**VOX KEY [VOX]** (p. 6-2)

(Mode: SSB/AM/FM/DV)

**VOX** ➔ Touch to turn the VOX function ON or OFF.  
 ➔ Touch for 1 second to display the “VOX” screen.  
 • Push **MENU** to return to the previous screen.

✓ **What is the VOX function?**

The VOX function (voice operated transmission) automatically starts transmission when you speak into the microphone, then automatically returns to receive when you stop speaking.

**BK-IN KEY [BK-IN]** (p. 6-3)

(Mode: CW)

**BK-IN** ➔ Push to toggle the break-in operation between semi break-in and full break-in, or to turn OFF the break-in function.  
 ➔ Hold down for 1 second to display the “BKIN” screen (Break-in). Push to return to the previous screen display.

✓ **What is the break-in function?**

The break-in function automatically switches between transmit and receive with your CW keying. Using Full break-in function (QSK), you can hear the receive frequency in-between keying.

Controller— Multi-function keys (Continued)

◇ **Function keys on D-1 display**

(Mode: DV) (when the DR mode is selected)

**SCAN KEY [SCAN]** (p. 12-4)

- Touch to start or cancel the Access repeater scan.
- Touch for 1 second to enter the “SCAN SET” mode screen.
- Push **[MENU]** to return to the previous screen.

**SKIP KEY [SKIP]** (p. 8-10)

- Touch to set the Skip setting ON or OFF for the Access repeater scan.
- “**SKIP**” is displayed when the Skip setting is ON.
- When a repeater is set as a skip target, the repeater cannot be selected in “FROM” (Access repeater).

**VOICE RECORDER KEY [VOICE]** (p. 15-2)

This function requires to insert an SD card.

- Touch to display the “VOICE TX” screen or the “VOICE” (Root) screen, depending on the “VOICE 1st Menu” option in the “Function” Set mode (p. 17-21).
- [SET]** > Function > **VOICE 1st Menu**
- Push **[MENU]** to return to the previous screen.

**CALL SIGN KEY [CS]** (p. 9-24)

- Touch to display the “CALL SIGN” screen.
- The current **call sign** for DV operation appears.
- Push **[MENU]** to return to the previous screen.

**CALL RECORD KEY [CD]** (p. 9-7)

- Touch to display the “RX HISTORY” screen.
- The call record channel appears. (RX01 to RX20)
- Push **[MENU]** to return to the previous screen.

◇ **Function keys on D-2 display**

(Mode: DV) (when the DR mode is selected)

**MEMORY WRITE KEY [MW]** (p. 11-5)

- Touch to display the Memory channel screen.
- Touch [MW] for 1 second to store the DR mode data into the selected memory channel.
- Push **[MENU]** to return to the previous screen.

**DIGITAL SQUELCH KEY [DSQL]** (p. 9-22)

- Touch to select a digital squelch function between digital call sign squelch and digital code squelch.
- Touch for 1 second to display the “DSQL” screen (digital squelch).
- Push **[MENU]** to return to the previous screen.

**DTMF MODE KEY [DTMF]** (p. 6-17)

- Touch to display the “**DTMF**” screen.
- Push **[MENU]** to return to the previous screen.

**VOX KEY [VOX]** (p. 6-2)

- Touch to turn the VOX function ON or OFF.
- Touch for 1 second to display the “VOX” screen.
- Push **[MENU]** to return to the previous screen.

✓ **What is the VOX function?**

The VOX function (voice operated transmission) automatically starts transmission when you speak into the microphone; then automatically returns to receive when you stop speaking.

## Controller — Rear and bottom panels

Rear panel

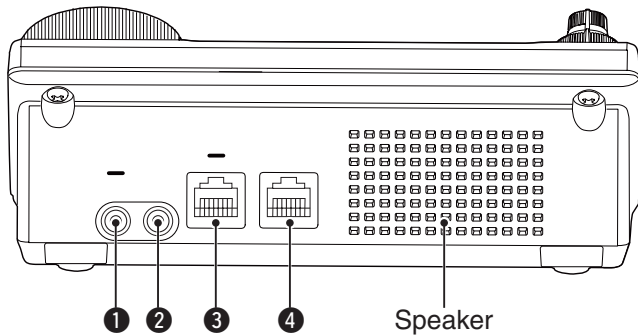

### 1 HEADPHONE/SPEAKER JACK [PHONES/SP]

Plug in standard stereo headphones (impedance: 8 to 16 Ω).

- Output power: More than 5 mW with an 8 Ω load.
- When headphones are connected, the internal speaker, and any external speaker, are disabled.
- When the [PHONES/SP] switch (6) on the bottom panel is set to the SPEAKER position, an external speaker can be used instead of headphones. This is convenient for mobile or outdoor operation.

### 2 ELECTRONIC KEYSER JACK [ELEC-KEY]

Plug in a bug or paddle type key to use the internal electronic keyer for CW operation. (p. 4-3)

- Set the keyer type to ELEC-KEY, BUG-KEY or Straight key in the “Keyer Type” item of the “KEYER SET” mode.
- When a straight key is connected, “Straight key” must be selected in the “Keyer Type” item of the “KEYER SET” mode. (p. 4-10)
- A straight key jack is located on the rear panel. See [KEY] on pages 1-17 and 2-7.
- You can reverse the keyer paddle polarity (dot and dash) in the “Paddle Polarity” item of the “KEYER SET” mode. (p. 4-10)
- Four keyer memory channels are available for your convenience. (p. 4-10)

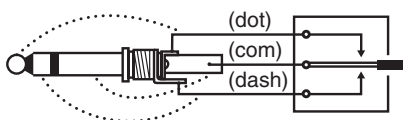

A standard 3.5(d) mm/ 1/8 inch plug

Bottom panel

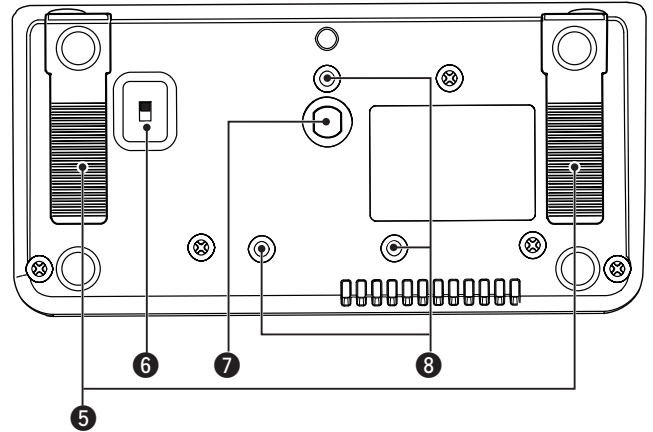

### 3 MICROPHONE CONNECTOR [MIC]

Plug in the supplied or an optional microphone.

- See page 21-4 for appropriate microphones.
- See page 1-20 for microphone connector information.
- The optional OPC-589 cable can be used to connect an 8-pin microphone such as the SM-30 or SM-50.
- A microphone connector is also available on the Main unit.
- ⚡ **DO NOT** simultaneously connect two microphones.

### 4 MAIN UNIT CONNECTOR [MAIN UNIT]

Connects to the Main unit using with the supplied OPC-2253 Control cable.

- The OPC-2253 Control cable is 3.5 meter (11.5 feet) long.
- ⚡ **DO NOT** use any third party's Ethernet cables.

### 5 STAND

The length of the stand can be adjusted in two steps.

- Adjust to the length not to incline back when you operate the Front panel.

### 6 PHONES/SPEAKER SWITCH [PHONE/SP]

Selects the [PHONES/SP] jack to connect a Headphones or external speaker.

### 7 SCREW HOLE FOR STAND

Accepts the screw of a tripod stand. (Third party product.)

### 8 SCREW HOLES FOR CONTROLLER BRACKET

Accepts the screws of the optional MBA-1 Controller bracket.

- The MBA-1 is required to install to the optional MBF-1 Mounting base.



## Main unit — Front panel

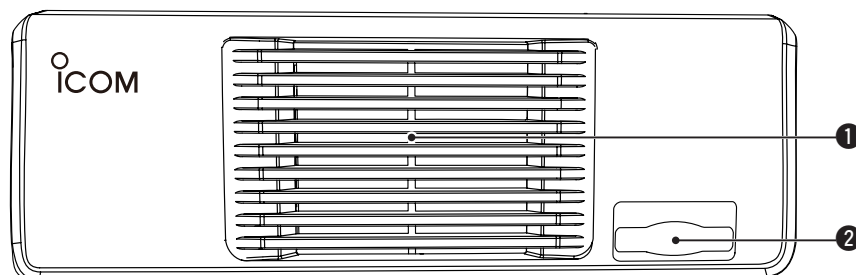

### ❶ COOLING FAN

This is a cooling fan for heat dissipation. Depending on the internal temperature, it rotates at a Low, Mid or High speed.

### ❷ SD CARD SLOT [SD CARD]

Insert an SD card of up to 32 GB SDHC. See Section 13 for details.



## Main unit — Rear panel

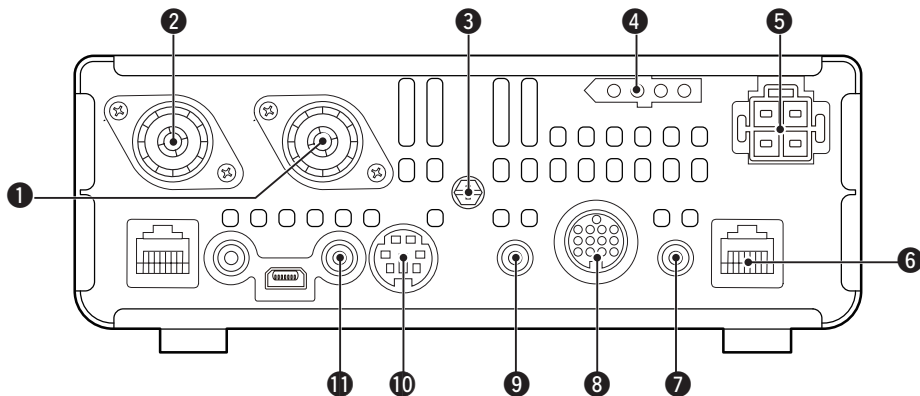

**1 ANTENNA CONNECTOR 1 [ANT1]**

**2 ANTENNA CONNECTOR 2 [ANT2]** (p. 2-3)

Connect a 50 Ω antenna with a PL-259 plug connector.

- [ANT1] is used for the HF, 50/70 MHz frequency bands.
- [ANT2] is used for the 144/430 MHz frequency bands.
- [ANT1] is used below 74.8 MHz, and [ANT2] is used for 74.8 MHz or above.

When using an optional AH-4 or AT-180 HF/50 MHz AUTOMATIC ANTENNA TUNERS, connect it to the [ANT1] connector.

**3 GROUND TERMINAL [GND]** (p. 2-2)

Connect this terminal to ground to prevent electrical shocks, TVI, BCI and other problems.

**4 TUNER CONTROL SOCKET [TUNER]** (p. 2-8)

Connect the control cable from an optional AH-4 HF/50 MHz AUTOMATIC ANTENNA TUNER.

**5 DC POWER SOCKET [DC 13.8V]** (p. 2-9)

Connect 13.8 V DC through the supplied DC power cable.

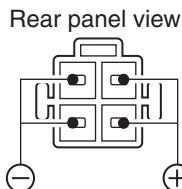

**6 CONTROLLER CONNECTOR [CONTROLLER]**

Connects to the Controller using with the supplied OPC-2253 Control cable.

- The OPC-2253 Control cable is 3.5 meter (11.5 feet) length.
- DO NOT use any third party's Ethernet cables.

**7 STRAIGHT KEY JACK [KEY]** (p. 2-7)

Connect a straight key or external electronic keyer using a standard 3.5(d) mm/ 1/8 inch plug.

- To use the internal electronic keyer for CW operation, connect to [ELEC-KEY] on the Rear panel of the Controller. (p. 1-15)

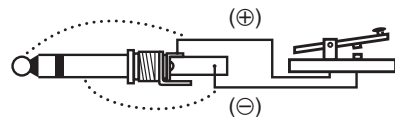

**8 ACCESSORY SOCKET [ACC]**

Connect control lines for external equipment such as a linear amplifier, an automatic antenna selector/tuner, a TNC for data communications, and so on.

- See page 1-19 for socket information.

**9 DATA1 JACK [DATA1]** (p. 2-8)

➤ Connect a PC through the optional OPC-1529R DATA COMMUNICATION CABLE, for low-speed data communication in the DV mode. (p. 9-17)

➤ Connect a GPS receiver through the optional OPC-1529R DATA COMMUNICATION CABLE, for GPS operation. (p. 10-2)

**10 DATA2 SOCKET [DATA2]** (p. 2-8)

Connect a TNC (Terminal Node Controller), and so on, for high speed data communications.

**11 CI-V REMOTE CONTROL JACK [REMOTE]**

(p. 2-8)

➤ Connect a PC, using the optional CT-17 CI-V LEVEL CONVERTER, for external control of the transceiver.

➤ Use for the transceive function with another Icom CI-V transceiver or receiver.

When the transceive function is set to ON, changing the frequency, operating mode and so on, on the IC-7100 automatically changes those settings on other Icom transceivers or receivers, and vice versa.

➤ Connect another IC-7100, using a mini plug cable\*, for transceiver to transceiver cloning.

\* Purchase separately

While cloning using the CS-7100 software, DO NOT connect anything to the [REMOTE] jack.

Main unit — Rear panel (Continued)

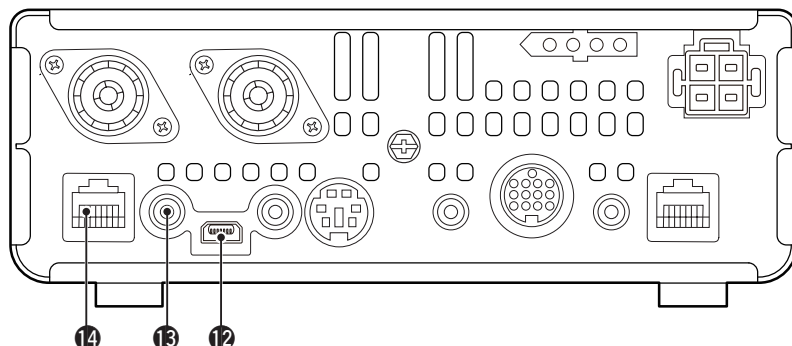

**12 USB (Universal Serial Bus) PORT [USB]**

Using a USB cable, connect a PC to do the following:

- Input modulation
- Remotely control the transceiver using **CI-V** commands (p. 20-2)
- Send the received audio to the PC
- Send the decoded characters to the PC
- Low-speed data communication in the DV mode (p. 9-17)
- Cloning using the optional CS-7100 CLONING SOFTWARE (p. 21-5)
- Remote control operation using the optional RS-BA1 IP REMOTE CONTROL SOFTWARE (p. 21-5)
- Two COM port numbers are assigned to the [USB] connector. One of them is "USB1," used for cloning and CI-V operation. The other one is "USB2," whose function is selected in "USB2 Function" item of the "Connectors" Set mode. (p. 17-25)

**[SET]** > Connectors > USB2/DATA1 Function > **USB2 Function**

**About the USB driver:**

The USB driver and the installation guide can be downloaded from our website.

➔ <http://www.icom.co.jp/world/index.html>

The following items are required:

**PC**

- Microsoft® Windows® XP, Microsoft® Windows Vista®, Microsoft® Windows® 7 or Microsoft® Windows® 8 OS
- A USB 1.1 or 2.0 port

**Other items**

- USB cable (supplied with the transceiver)
- PC software (such as the optional RS-BA1 or CS-7100)

**NEVER** connect the transceiver to a PC until the USB driver installation has been completed.

**About the modulation input:**

Select "USB" in the "Connectors" Set mode item "DATA OFF MOD" or "DATA MOD." The modulation input level from the USB jack can be set in the Set mode item "USB MOD Level." (p. 17-24)

**[SET]** > Connectors > **DATA OFF MOD**

**[SET]** > Connectors > **DATA MOD**

**[SET]** > Connectors > **USB MOD Level**

**13 EXTERNAL SPEAKER JACK [SP]**

Connect to an external speaker (4 to 8 Ω).

**14 MICROPHONE CONNECTOR [MIC]**

Plug in the supplied or an optional microphone.

- See page 21-4 for appropriate microphones.
- See page 1-20 for microphone connector information.
- The optional OPC-589 cable can be used to connect an 8-pin microphone such as the SM-30 or SM-50.
- A microphone connector is also available on the Controller.

**DO NOT** simultaneously connect two microphones.

# 1 PANEL DESCRIPTION

## Main unit — Rear panel (Continued)

### ◇ ACC socket information

#### • ACC socket

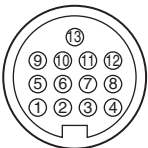
ACC	PIN No.	NAME	DESCRIPTION	SPECIFICATIONS	
 <p>Rear panel view</p> <p>① brown ⑧ gray ② red ⑨ white ③ orange ⑩ black ④ yellow ⑪ pink ⑤ green ⑫ light blue ⑥ blue ⑬ light green ⑦ purple</p> <p>Color refers to the cable strands of the supplied cable.</p>	1	8 V	Regulated 8 V output.	Output voltage: 8 V ± 0.3 V Output current: Less than 10 mA	
	2	GND	Connects to ground.	—	
	3	HSEND <sup>*1, 2</sup>	Input/output pin.	An external equipment controls the transceiver. When this pin goes low, the transceiver transmits. The transceiver outputs a low signal to control external equipment.	Input voltage (High): 2.0 V to 20.0 V Input voltage (Low): -0.5 V to +0.8 V Current flow: Maximum 20 mA Output voltage (Low): Less than 0.1 V Current flow: Maximum 200 mA
	4	BDT	Data line for the optional AT-180.	—	
	5	NC (BAND <sup>*3</sup> )	<sup>*3</sup> If the modification is performed, band voltage output. (p. 19-11)	—	
	6	ALC	ALC voltage input.	Control voltage: -4 V to 0 V Input impedance: More than 3.3 kΩ	
	7	VSEND <sup>*1, 2</sup>	Input/output pin.	An external equipment controls the transceiver. When this pin goes low, the transceiver transmits. The transceiver outputs a low signal to control external equipment.	Input voltage (High): 2.0 V to 20.0 V Input voltage (Low): -0.5 V to +0.8 V Current flow: Maximum 20 mA Output voltage (Low): Less than 0.1 V Current flow: Maximum 200 mA
	8	13.8 V	13.8 V output when power is ON.	Output current: Less than 1 A	
	9	TKEY	Key line for the optional AT-180.	—	
	10	FSKK	Controls RTTY keying	“High” level: More than 2.4 V “Low” level: Less than 0.6 V Output current: Less than 2 mA	
	11	MOD	Modulator input.	Input impedance: 10 kΩ Input level: Approx. 100 mV rms	
	12	AF <sup>*3</sup>	AF detector output. Fixed level, regardless of the [AF] control position.	Output impedance: 4.7 kΩ Output level: 100 to 300 mV rms	
	13	SQL S	Squelch output. Grounded when squelch opens.	SQL open: Less than 0.3 V/5 mA SQL closed: More than 6.0 V/100 μA	

<sup>\*1</sup> When the SEND terminal controls the inductive load (such as a relay), a counter-electromotive force can cause the transceiver’s malfunction or damage. To prevent this, we recommend adding a switching diode, such as an “1SS133,” on the load side of the circuit to the counter-electromotive force absorption.

When the diode is added, a switching delay of the relay may occur. Be sure to check its switching action before operation.

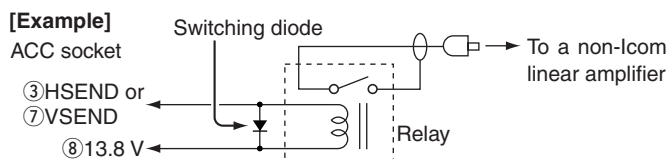

<sup>\*2</sup> VSEND is used for the 144 MHz and 430 MHz bands, and HSEND is used for the HF, 50/70 MHz bands by default. You can change this setting in “VSEND Select” of the “Connectors” Set mode. (p. 17-26)

**[SET]** > Connectors > **VSEND Select**

<sup>\*3</sup> You can change this setting in “ACC/USB Output Select” of the “Connectors” Set mode. (p. 17-24)

**[SET]** > Connectors > **ACC/USB Output Select**

# 1 PANEL DESCRIPTION

## Main unit — Rear panel (Continued)

### • When connecting the ACC conversion cable (OPC-599)

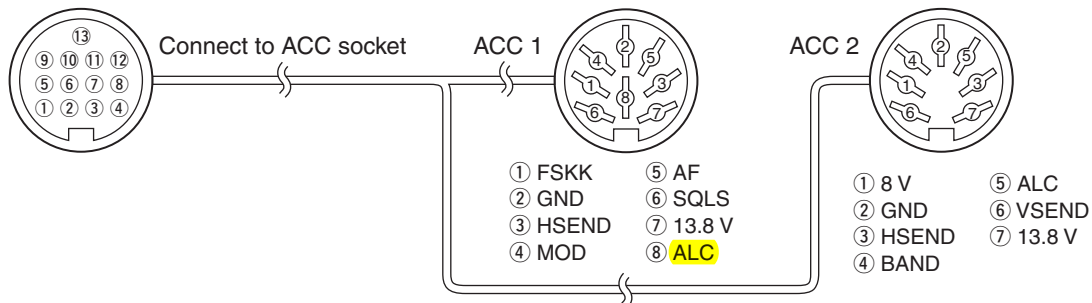

### ◇ DATA2 socket information

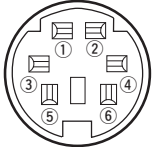
DATA2	PIN No.	NAME	DESCRIPTION	SPECIFICATIONS
 <p>Rear panel view</p>	1	DATA IN	Input terminal for data transmit. (1200 bps: <b>AFSK</b> 9600 bps: G3RUH, GMSK)	Input level (1200 bps): 100 mV Input level (9600 bps): 0.2 to 0.5 Vp-p
	2	GND	Common ground for DATA IN, DATA OUT and AF OUT.	—
	3	PTT	PTT terminal for packet operation. Connect to ground to activate the transmitter.	Input voltage (High): 2.0 V to 20.0 V Input voltage (Low): -0.5 V to +0.8 V
	4	DATA OUT	Data out terminal for 9600 bps operation only.	Output impedance: 10 kΩ Output level: 1.0 Vp-p
	5	AF OUT	Data out terminal for 1200 bps operation only.	Output impedance: 4.7 kΩ Output level: 100–300 mV rms
	6	<b>SQL</b>	Squelch out terminal. This pin is grounded when the transceiver receives a signal which opens the squelch. <ul style="list-style-type: none"> <li>To avoid interfering transmissions, connect squelch to the TNC to inhibit transmission when squelch is open.</li> <li>Keep RF gain at a normal level, otherwise a “SQL” signal will not be output.</li> </ul>	SQL open: Less than 0.3 V/ 5 mA SQL closed: More than 6.0 V/ 100 μA

### ◇ Microphone connector information

MIC	PIN No.	NAME	DESCRIPTION	SPECIFICATIONS
 <p>Rear panel view</p>	1	8 V	+8 V DC output.	Maximum 10 mA
	2	MIC U/D	Frequency Up/Down	UP: Ground DN: Ground through 470 Ω
	3	M8V SW	HM-151 connection Ground to indicate the HM-151 is connected. When the HM-151 is not connected; outputs an AF.*1	—
	4	PTT	PTT input	—
	5	MIC E	Microphone ground	—
	6	MIC	Microphone input	—
	7	GND	Ground	—
	8	DATA IN	When the HM-151 is connected; HM-151 data input	—
	SQL SW	When the HM-151 is not connected; Squelch switch	Open: ‘Low’ level Close: ‘High’ level	

\*1 You can change this setting in “MIC AF Out” of the “Function” Set mode. (p. 17-22)

**[SET]** > Function > **MIC AF Out**

# Microphone

◇ HM-198 (Supplied)

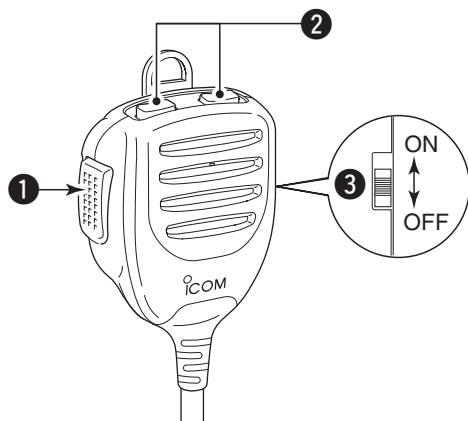

**1 PTT SWITCH**

Hold down to transmit, release to receive.

**2 UP/DOWN KEYS [UP]/[DN]**

- Push either key to change the operating frequency, memory channel, Set mode setting, and so on. (pp. 3-9, 4-11, 11-3)
- Hold down either key for 1 second to start scanning.

**3 UP/DN LOCK SWITCH**

Slide to turn the [UP]/[DN] keys lock function ON or OFF.

Microphone (Continued)

The optional OPC-589 cable is required to connect these 8-pin microphones.

◇ SM-50 (Option)

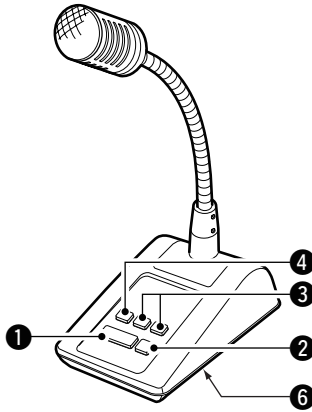

◇ SM-30 (Option)

TOP VIEW

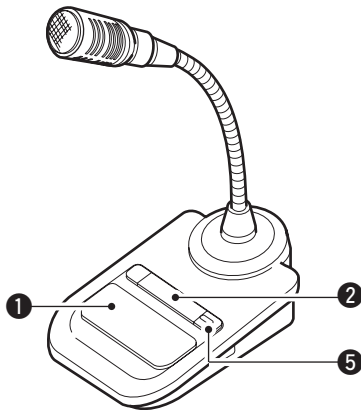

BOTTOM VIEW

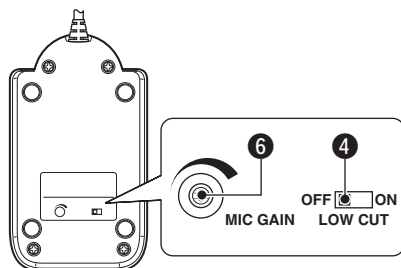

1 PTT SWITCH

Hold down to transmit, release to receive.

2 PTT LOCK SWITCH

Push to lock the PTT switch in the transmit mode.

3 UP/DOWN SWITCHES [UP]/[DN]

Change the selected readout frequency or memory channel.

- Holding down continuously changes the frequency or memory channel number.
- While holding down [XFC], the transmit readout frequency can be controlled while in the split frequency mode.
- The [UP]/[DN] switch can simulate a key paddle. Preset in the "KEYER SET" mode (U/D KEY; MIC Up/Down Keyer). (p. 4-10)

4 LOW CUT SWITCH

Push (SM-50)/Slide (SM-30) to cut out the low frequency components of input voice signals.

5 PTT LOCK INDICATOR [LOCK]

(Only for the SM-30)  
Lights red when the PTT lock switch (2) is ON.

6 MIC GAIN VOLUME [MIC GAIN]

- Rotate to adjust the microphone output level.
  - Use this control as an addition to the microphone gain setting of the connected transceiver.
- Rotating the control too far clockwise may result in an output level that is too high and transmit signal distortion.

## Microphone (Continued)

### ◇ HM-151 (Option)

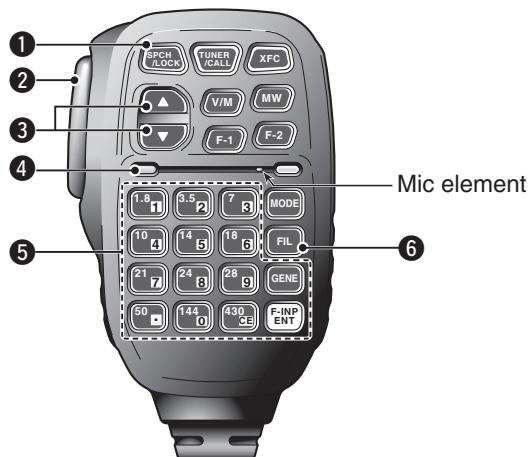

#### 1 SPCH/LOCK KEY [SPCH/LOCK]

##### ○ SPEECH KEY Operation (p. 3-20)

Push to audibly announce the S-meter level, the displayed frequency and the operating mode.

- The S-Level announcement can be turned OFF in the “S-Level SPEECH” item of the “SPEECH” Set mode. (p. 17-15)

**[SET]** > SPEECH > **S-Level SPEECH**

- When RIT is ON, the RIT offset is not included in the frequency announcement.

##### ○ LOCK KEY Operation (p. 5-12)

Hold down for 1 second to turn the Lock function ON or OFF.

- The function electronically locks the Dial.
- “” appears when the function is ON.
- You can select the Dial lock and Panel lock in the “Lock Function” item of the “Function” Set mode (p. 17-20).

**[SET]** > Function > **Lock Function**

#### 2 PTT SWITCH [PTT] (p. 3-23)

Hold down to transmit, release to receive.

#### 3 UP/DOWN KEYS [▲]/[▼]

Change the operating frequency.

- Hold down to continuously change the frequency.
- If the Quick tuning icon is not displayed, the tuning step is 50 Hz.

#### 4 TRANSMIT LED

Lights red while transmitting.

#### 5 KEYPAD

- Pushing a key selects the operating band.
  - **[(GENE)•]** selects the general coverage band.
- Pushing the same key 2 or 3 times calls up other stacked frequencies in the band.
  - Icom’s triple band stacking register memorizes 3 frequencies in each band.
- After pushing **[(F-INP)ENT]**, enter a numeric frequency, then press **[(F-INP)ENT]** again.
  - Example: To enter 14.195 MHz, push **[(F-INP)ENT]** **[1] [4] [•] [1] [9] [5] [(F-INP)ENT]**.

#### 6 FILTER SELECTION KEY [FIL]

- Push to select one of three IF **filter** settings.
  - The selected filter passband width and shifting value are displayed for 2 seconds in the window.
- Push for 1 second to display the “FILTER” screen to adjust the filter passband width.
- When the “FILTER” screen is displayed, push for 1 second to return to the previous screen.



## Microphone

◇ HM-151 (Option) (Continued)

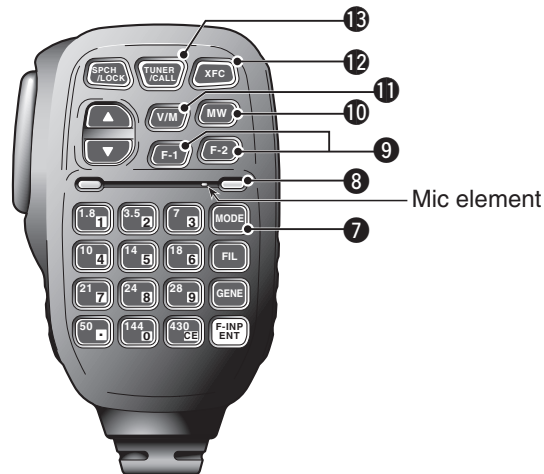

### 7 MODE KEY [MODE]

- Push to cycle through the operating modes:  
USB/LSB ▶ CW/CW-R ▶ RTTY/RTTY-R ▶ AM  
▶ FM ▶ WFM ▶ DV
- Hold down for 1 second to toggle the following operating modes:  
USB ↔ LSB  
CW ↔ CW-R  
RTTY ↔ RTTY-R

### 8 POWER LED

Lights green when transceiver's power is ON.

### 9 PROGRAMMABLE FUNCTION KEYS [F-1]/[F-2]

Program and perform a selected function.

- The functions can be assigned in the "RC MIC" item of the "Function" Set mode (p. 17-22). The default settings for [F-1] and [F-2] are "MPW" and "MPR."

**[SET]** > Function > **RC MIC**

### 10 MEMORY WRITE KEY [MW] (pp. 11-5, 11-6)

Hold down for 1 second to store VFO data into the selected memory channel.

- This can be done in both the VFO and memory modes.

### 11 VFO/MEMORY SELECTION KEY [V/M]

- Push to switch between the VFO and memory modes. (p. 3-4)
- Hold down for 1 second to copy the memory contents to the displayed VFO. (p. 11-9)

### 12 TRANSMIT FREQUENCY CHECK KEY [XFC]

- During split frequency or repeater operation, hold down to listen to the transmit frequency. (p. 4-28)
  - While holding down this switch, the transmit frequency can be changed with the Dial or **[MPAD]**.
  - When the Split Lock function is turned ON in the Split operation, hold down **[XFC]** to cancel the Dial lock function. (p. 6-10)
- When operating simplex, hold down to monitor the frequency.
  - While holding down this key, the squelch is open and the interference reject functions are temporarily turned OFF.
- When operating simplex and the RIT function is turned ON, hold down to listen to the transmit frequency. The frequency is the same as when the RIT is OFF.
- In the DV mode, hold down this key to select the RX monitoring mode. (p. 17-13)

### 13 TUNER/CALL KEY [TUNER/CALL]

- ANTENNA TUNER KEY Operation (p. 16-4)  
**(Frequency band: HF, 50/70\* MHz)**
  - Push to turn an optional **antenna tuner** ON or OFF (bypass).
  - Hold down for 1 second to manually start the antenna tuner.
    - If the tuner cannot tune the antenna within 20 seconds, the tuning circuit is automatically bypassed.
- \* 70 MHz band transmission is available, depending on the transceiver version.
- CALL KEY Operation (p. 11-4)  
**(Frequency band: 144/430 MHz)**  
Push to select the Call channel.



<b>Selecting a location</b> .....	<b>2-2</b>
◇ Installing the transceiver in a vehicle.....	2-2
<b>Grounding</b> .....	<b>2-2</b>
<b>Antenna connection</b> .....	<b>2-3</b>
<b>Connect controller to transceiver</b> .....	<b>2-4</b>
◇ The Main unit installation .....	2-4
<b>Installing the Controller</b> .....	<b>2-5</b>
<b>Connecting accessories to the controller</b> .....	<b>2-6</b>
<b>Required Connections to a Transceiver</b> .....	<b>2-7</b>
<b>The External Units Connections to a Transceiver</b> .....	<b>2-8</b>
<b>Power Supply Connections</b> .....	<b>2-9</b>
◇ Connecting the PS-126 power supply.....	2-9
◇ Battery connections.....	2-9
◇ Connecting a non-Icom DC power supply.....	2-9
<b>Linear Amplifier Connections</b> .....	<b>2-10</b>
◇ Connecting the IC-PW1/EURO .....	2-10
◇ Connecting a non-Icom linear amplifier.....	2-11

## Selecting a location

Select a location for the transceiver that allows adequate air circulation, free from extreme heat, cold, vibrations, away from TV sets, TV antenna elements, radios and other electromagnetic sources.

The base of the transceiver has adjustable feet for the desktop use. Set the feet to one of two angles, to meet your operating preference.

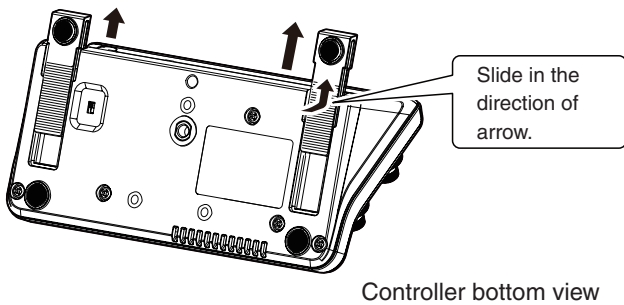

## Grounding

To prevent electrical shock, television interference (TVI), broadcast interference (BCI) and other problems, ground the transceiver using the GROUND terminal on the rear panel.

For best results, connect a heavy gauge wire or strap to a long ground rod. Make the distance between the [GND] terminal and ground as short as possible.

**WARNING! NEVER** connect the [GND] terminal to a gas or electric pipe, since the connection could cause an explosion or electric shock.

## ◇ Installing the transceiver in a vehicle

Controller  
DC power cable  
Main unit  
Controller cable  
Battery (12V)

Controller  
Controller  
Main unit  
Main unit

The following optional devices can be installed, as shown to the right.

- MBA-1: Controller bracket
- MBF-1: Mount base
- MB-62: Mobile mounting bracket

Please refer to the pages 2-4 and 2-5 for installation details.

## Antenna connection

For radio communications, the antenna is of critical importance, along with output power and receiver **sensitivity**. Select a well-matched 50 Ω antenna and coaxial cable feedline. We recommend 1.5:1 or better Voltage Standing Wave Ratio (VSWR) on your operating bands. The transmission line should be a coaxial cable. When using a single antenna (for the HF, 50/70 MHz bands), use the [ANT1] connector.

**CAUTION:** Protect your transceiver from lightning by using a lightning arrestor.

### Antenna connection

Connect the cable from your HF, 50/70 MHz antenna to the [ANT 1] connector.  
 Connect the cable from your 144/430 MHz antenna to the [ANT 2] connector.

### Installation example

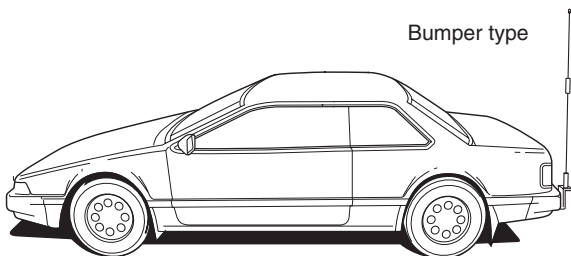

### Antenna SWR

Each antenna is tuned for a specified frequency range, and the SWR usually increases outside the range. When the SWR is higher than approximately 2.0:1, the transceiver automatically reduces the transmit power to protect the final transistors. In that case, an **antenna tuner** is useful to match the transceiver and antenna. Low SWR allows full power for transmitting. The IC-7100 has an SWR meter to continuously monitor the antenna SWR.

### PL-259 CONNECTOR INSTALLATION EXAMPLE

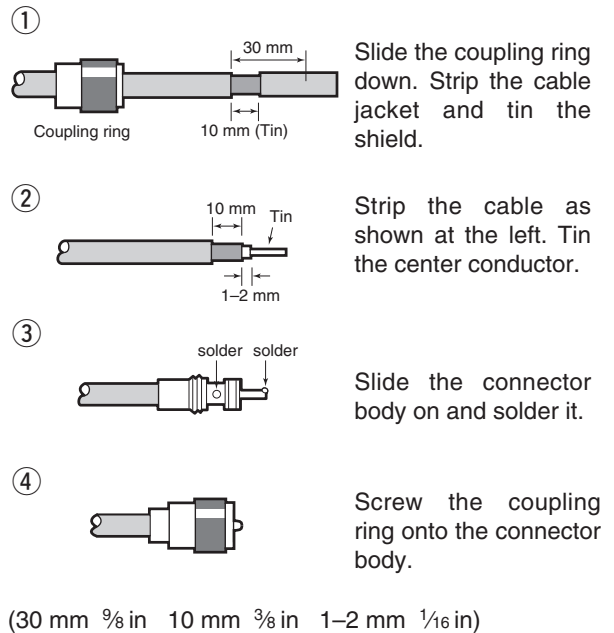

## Connect controller to transceiver

The Main unit becomes hot when transmitted for long period of time.

**DO NOT** place anything on the transceiver. It may obstruct radiation and cause mechanical trouble.

### Using Ferrite EMI filter\*

Depending on the installed condition of the transceiver, malfunction may occur by the wraparound of the electric wave. This problem can be resolved by using the Ferrite EMI filter.

\*The filter connection is required for the European versions.

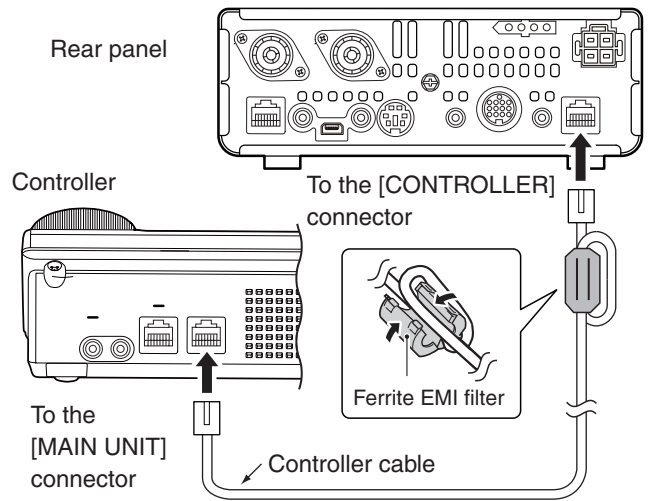

## ◇ The Main unit installation

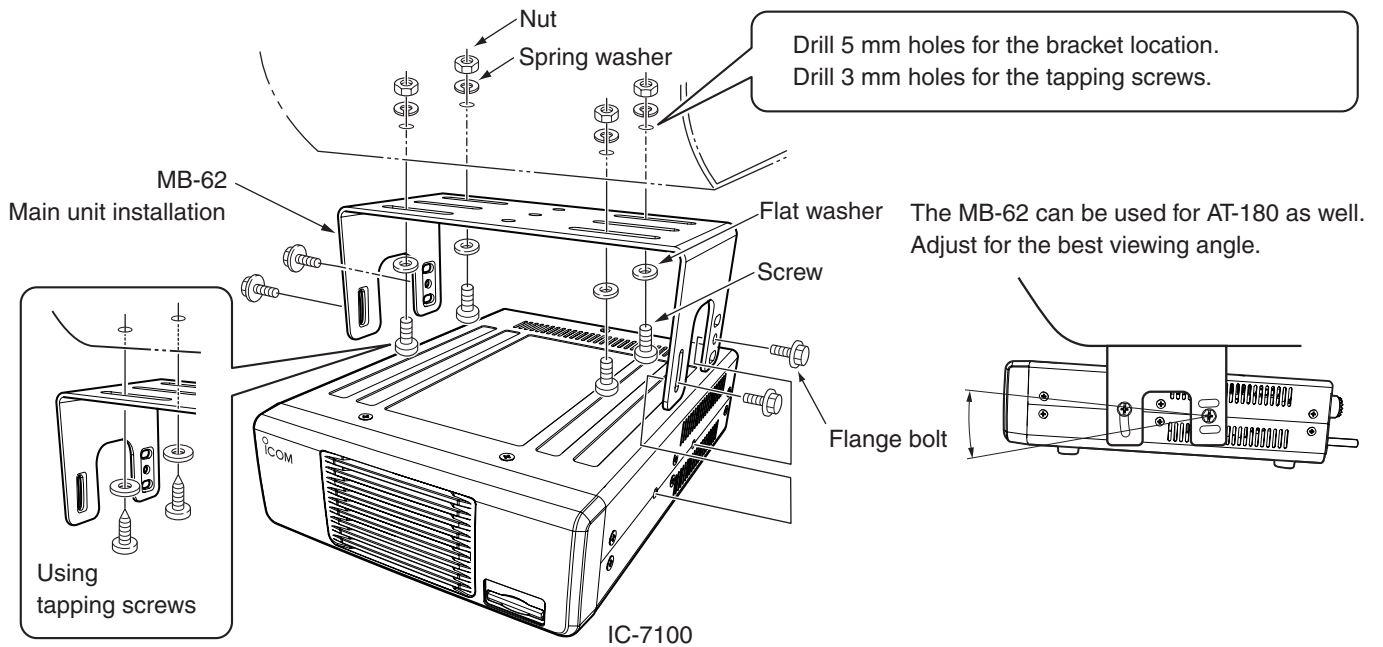

## Installing the Controller

The controller can be installed on the dashboard of a vehicle or console by using the optional Controller bracket.

### • Controller installation procedures

#### 1. Place the controller bracket on a dashboard or console.

Place the MBF-1 holder. Refer to the MBF-1 installation manual.

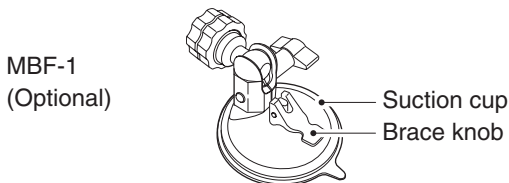

#### 2. Attach the bracket to the Controller.

Tighten the screws to attach the bracket to the Controller. (The screws are supplied with the MBA-1)

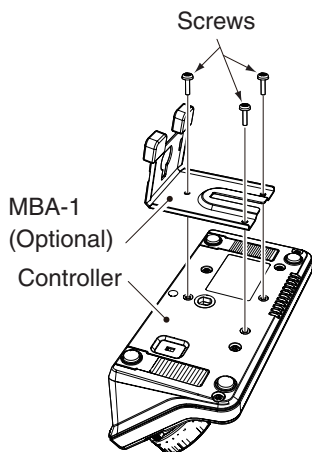

#### 3. Connect the Controller to the bracket

There are 2 ways to mount the controller. Select the best way for your environment.

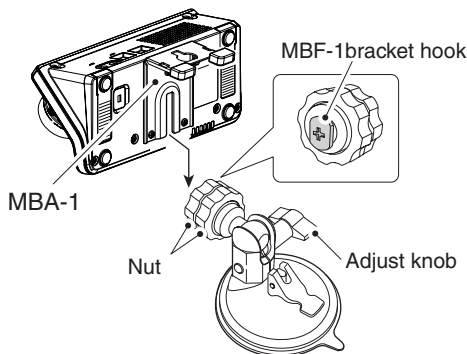

- ① Insert the MBA-1 guide to the MBF-1 bracket hook.
- ② Tighten the nut.
- ③ Adjust the tilt with the adjust knob.

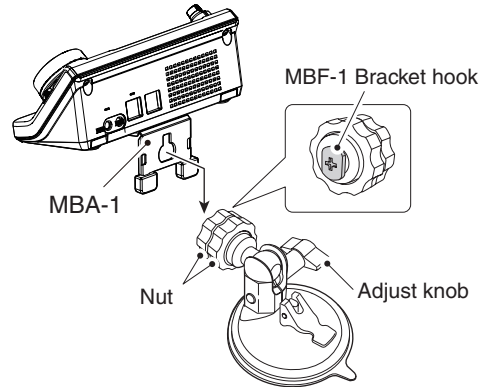

- ④ Insert the MBA-1 guide to MBF-1 bracket hook.
- ⑤ Tighten the nut.
- ⑥ Adjust the angle, then tighten the adjust knob.

#### 4. Cushion

If the Controller vibrates and hits to the dashboard or console when driving, use the cushion supplied with the Controller bracket.

When the Controller is fixed, tighten the adjustment knob while pressing it to the stuck cushion. The MBF-1 includes 2 sheets of cushions for each different thickness.

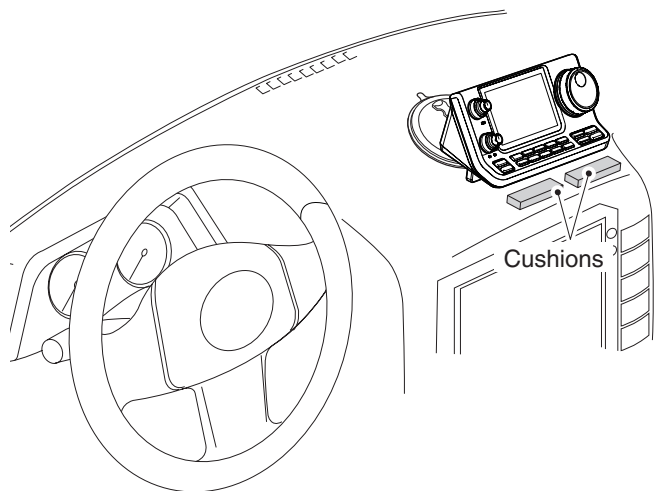

## Connecting accessories to the controller

[MIC] connector  
HM-151

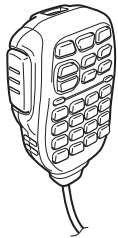

HM-198



Adapter cable + Microphone

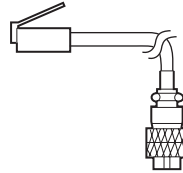

OPC-589



HM-36

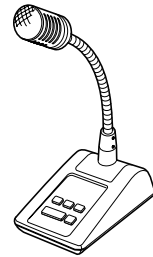

SM-50

**DO NOT** connect 2 microphones at the same time. If they are connected to the controller and the Main unit at the same time, the both microphones will be ON while transmitting.

**CAUTION: NEVER** connect or use the optional HM-151 (microphone) with any other transceiver. This could damage the transceiver. The HM-151 is designed to use with the IC-7000/IC-7100 series ONLY.

• **External Keypad**

Control the CW memory keyer transmission from the external keypad by connecting the control circuit to the MIC connector.

Set the “Keyer” item in the “Connectors,” and set the mode to “ON” to use the external keypad. (p. 17-25)

• **Data transmission (AFSK)**

Connect a TNC (Terminal Node Controller) to the [MIC] connector to enable data transmission (AFSK). (p. 18-2)

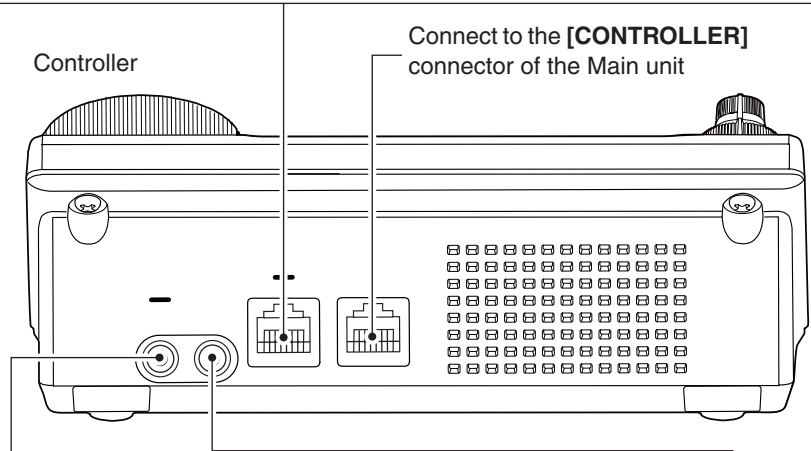

**[PHONES/SP] (Headphones/External Speaker) Jack**

Set the switch on the bottom of the Controller to “PHONES” to use headphones and set it to “SP” to use a speaker.

Bottom of the controller



External speaker

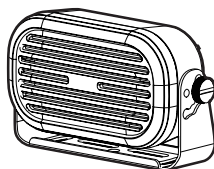

SP-35 (Optional)

The transceiver accepts headphones with maximum 5 mW in to an 8 Ω impedance. The sound level may differ, depending on the headphones.

3.5(d) mm/1/8” plug

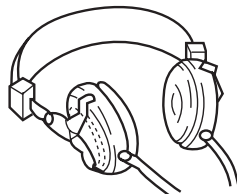

Headphones

**[ELEC-KEY] (Electronic keyer) Jack**

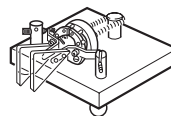

A jack to connect the paddle with electrode control on the end terminal.

dash

Connect to the transceiver’s [KEY] Jack to use the Electronic keyer (p. 2-7)

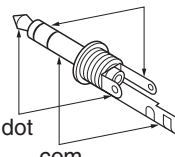

dot  
com

• The internal keyer is set as the default but it can be changed in 3.5(d) mm/1/8” plug the “keyer” Set mode (p. 4-10)

## Required Connections to a Transceiver

**[ANT2] 144/430MHz BANDS CONNECTOR (p. 2-3)**

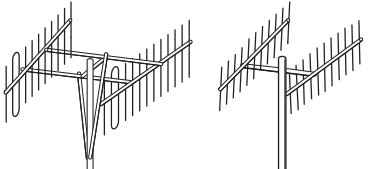

Connect a 50 Ω antenna for the 144/430 MHz frequency bands or 74.8 MHz and above.

**[ANT1] HF, 50/70 MHz BANDS CONNECTOR (P. 2-3)**

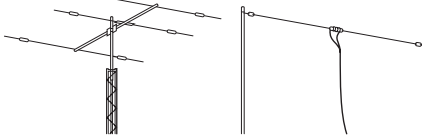

Connect a 50 Ω antenna for the HF, 50/70 MHz frequency bands or below 74.8 MHz.

**[DC 13.8V] DC POWER SUPPLY (P. 2-9)**

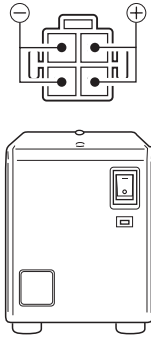

Use a power supply with 13.8 V DC output and a capacity of at least 22 Amperes.  
PS-126 (Optional)

**[MIC] MODULAR MICROPHONE CONNECTOR (p. 2-6)**

As with a microphone connector of the controller, accepts the supplied microphone.

IC-7100

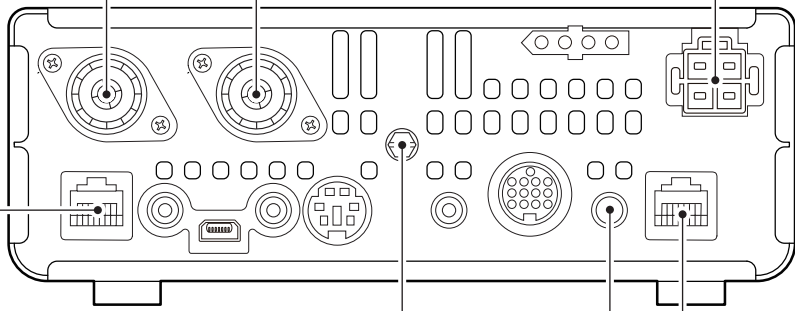

**[GND] GROUND TERMINAL (p. 2-2)**

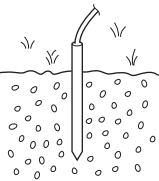

Connect this terminal to a station or vehicle ground to prevent electrical shocks, TVI, BCI and other problems.

**STRAIGHT KEY JACK**

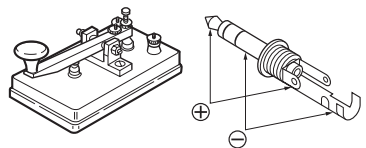

Plug diameter: 3.5 mm/1/8"  
Accepts a straight key or an external electronic keyer.

Connect to the **[MAIN UNIT]** connector of the controller. (p. 2-4)

## The External Units Connections to a Transceiver

**[DATA1] DATA1 JACK**

**For GPS operation (p. 10-2)**

- Connect a GPS receiver to the transceiver.
- The optional OPC-1529R (Data communication cable) and a 3rd party's GPS receiver with RS-232C Port are required.

**For low-speed data communication in the DV mode (p. 9-17)**

- Connect the transceiver to a PC.
- The USB cable can also be used for low-speed data communication..



OPC-1529R (Optional)

**[TUNER] TUNER CONTROL SOCKET (p. 16-1)**

Connect the control cable from an optional AH-4 (HF/50 MHz automatic antenna tuner).

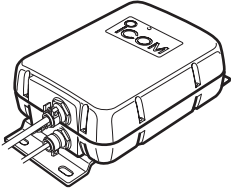

AH-4 (Optional)

**AH-2b (Optional)**

- Connected to AH-4

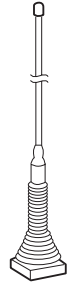
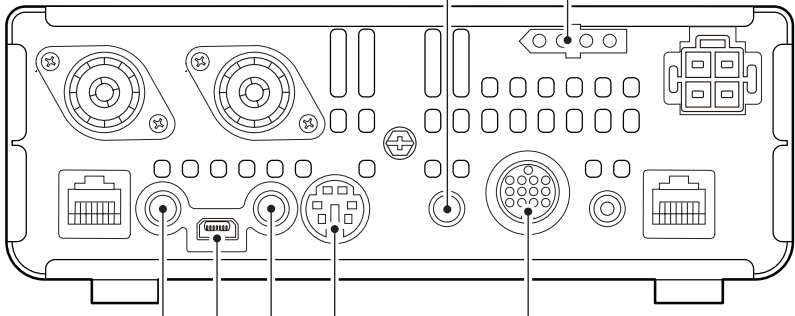



**[SP] (EXTERNAL) SPEAKER JACK (p. 2-6)**

Similar to the [PHONES/SP] jack on the controller. Plug in an external speaker. 3.5(d) mm/1/8" plug

**[DATA2] DATA2 SOCKET (p. 18-2)**

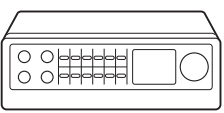
Connect a TNC (Terminal Node Controller) for packet communication.



**[ACC] ACCESSORY SOCKET (p. 1-19)**

Connect control lines for external equipment such as TNC or a PC.

**[USB] USB (Universal Serial Bus) PORT**

- Remotely control the transceiver using **CI-V** commands (p. 20-2)
- Send the received audio to the PC
- Input modulation (pp. 1-18, 17-8)
- Send the decoded RTTY outputs to the PC
- Low-speed data communication in the DV mode (p. 9-17)
- Cloning using the optional CS-7100 CLONING SOFTWARE (p. 19-5)
- Remotely control using the optional RS-BA1

**[REMOTE] REMOTE CONTROL JACK**

- Remotely control the transceiver using CI-V commands. (p. 20-2)
- Cloning between transceivers (p. 19-5)
- 3.5(d) mm/1/8" plug

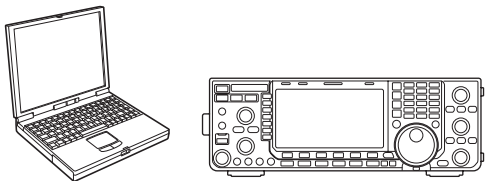

**NOTE:** By setting "ACC/USB output selection" of the Connectors Set mode (p. 17-24), the receiving tone can normally be output from the [ACC] socket, and the [USB] port can output an IF signal (12 kHz). This is required for the Software-Defined Radio (SDR) operation. The Digital Radio Mondiale (DRM) broadcast can be received using SDR.

**CAUTION: DO NOT** connect any device to [REMOTE] when cloning using the optional CS-7100 CLONING SOFTWARE.



## Power Supply Connections

Make sure the [POWER] switch is OFF before connecting the DC power cable.

- We recommend using Icom's optional power supply (PS-126: DC13.8 V/25 A).

### ◇ Connecting the PS-126 power supply

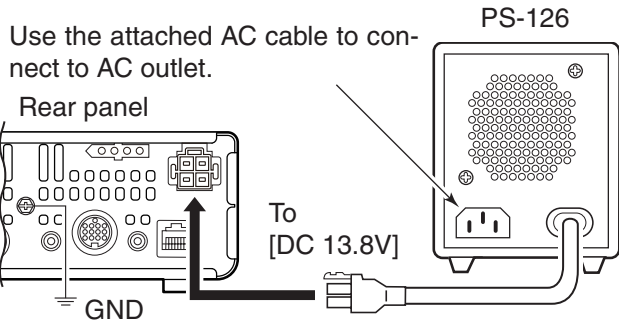

### ◇ Battery connections

#### ⚠ WARNING!

- **NEVER** connect to a battery without supplying a DC fuse, otherwise a fire hazard occurs.
- **NEVER** connect the transceiver directly to a 24 V battery.

The transceiver may not receive well on some frequencies when installed in a hybrid vehicle, or any type of electric vehicle (fuel cell vehicle). This is because vehicle's electric components such as the inverter system generate a lot of electric noise.

- **DO NOT** use a cigarette lighter socket as a power source when operating in a vehicle. The plug may cause voltage drops and ignition noise may be superimposed onto transmit or receive audio.
- Use a rubber grommet when passing the DC power cable through a metal plate to prevent a short circuit.

The transceiver needs followings:

- DC 13.8 V (Capacity: 22 A and over)
- A power supply with an over current protective line and with a less voltage fluctuation or ripple

### ◇ Connecting a non-Icom DC power supply

Connect the black DC power cable to the (–) Negative terminal, and the red DC power cable to the (+) Positive terminal.

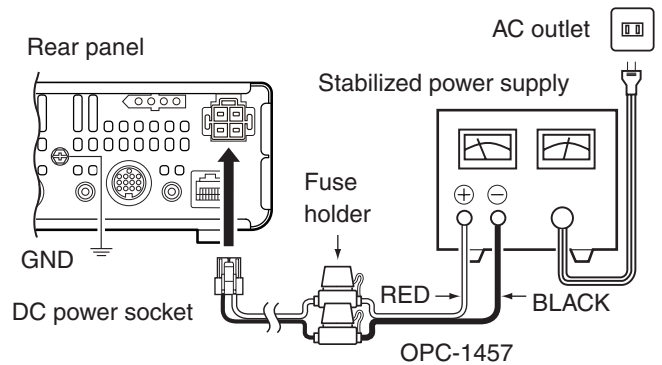

For European versions

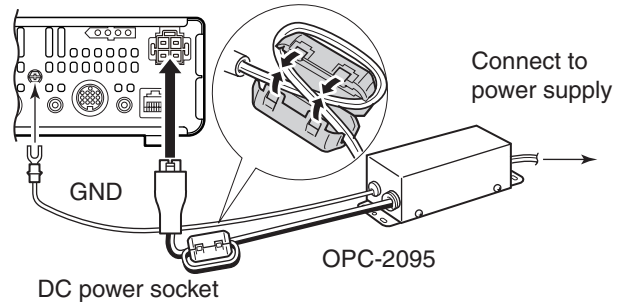

#### ⚠ WARNING! (About DC power supply)

- Make sure DC power cable polarity is correct.  
Red: Positive + terminal  
Black: Negative – terminal
- **NEVER** cut the DC power cable between the DC plug and fuse holder.
- **DO NOT** use unattached or undesignated DC power cable.
- **DO NOT** forcibly pull or bend the DC power cable. Install the devices far enough from the place where people might put things or step on the DC power cable.

### CONNECTING A VEHICLE BATTERY

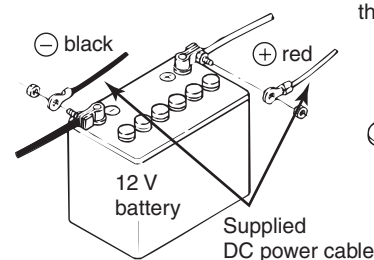
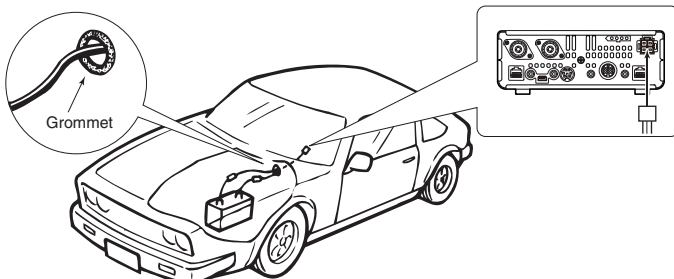

**NOTE:** Use terminals for the cable connections.

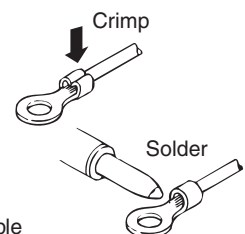

# Linear Amplifier Connections

## ◇ Connecting the IC-PW1/EURO

To connect the Icom IC-PW1/EURO, see the diagram below.  
For IC-PW1/EURO operation, refer to the amplifier's instruction manual.

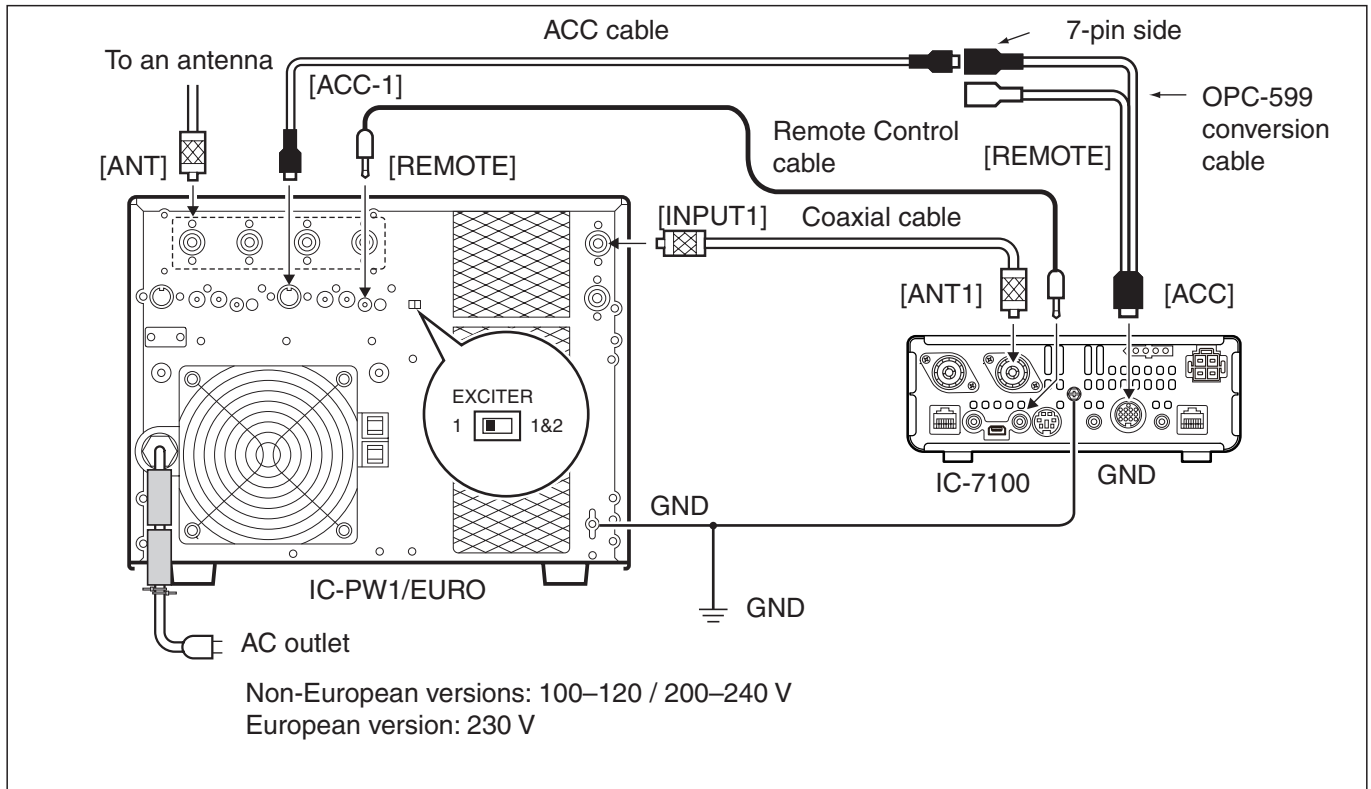

**Linear Amplifier Connections (Continued)**

◆ **Connecting a non-Icom linear amplifier**

To connect a non-Icom HF, 50/70\*<sup>1</sup> MHz bands linear amplifier, see the diagram below.

\*<sup>1</sup> 70 MHz band transmission is available, depending on the transceiver version.

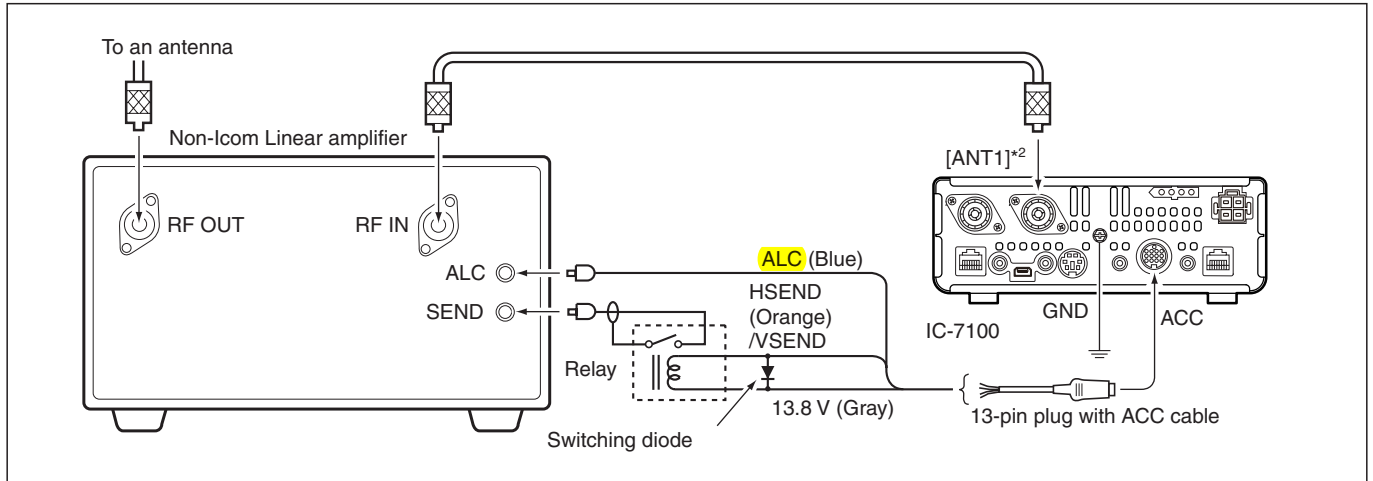

\*<sup>2</sup> When connecting a 144 MHz or 430 MHz band's liner amplifier, connect to [ANT2].

**⚠ WARNING!**

The SEND terminal of the linear amplifier must be connected to the HSEND (ACC connector pin 3) for the HF, 50/70\* MHz bands, and to VSEND (ACC connector pin 7) for the 144/430 MHz bands. An external relay must be used.

\* 70 MHz band transmission is available, depending on the transceiver version.

When the HSEND (or VSEND) terminal controls the inductive load (such as a relay), a counter-electromotive force can damage or cause the transceiver to malfunction. To prevent this, add a switching diode on the load side of the circuit to the counter-electromotive force absorption.

- We recommend adding a switching diode, such as an “1SS133”.
- When the diode is added, a switching delay of the relay may occur. Be sure to check its switching action before operating.

The ALC input level must be in the range 0 V to –4 V. The transceiver does not accept positive voltage. Non-matched ALC and RF power settings could cause a fire or damage the linear amplifier.

When using a linear amplifier such as IC-PW1/EURO, adjust the output power to stay within the ALC zone by pushing **MIC/RF PWR**(**C**). For ALC zone information, refer to ‘Basic transmit operation.’ (p. 3-23)

When using a linear amplifier that has a time delay between receiving and transmitting, a high SWR might cause the linear amplifier to malfunction. To prevent this, slow the TX Delay the “TX Delay” settings in the “Function” Set mode. (p. 17-19)

**SET**(**C**) > Function > **TX Delay**

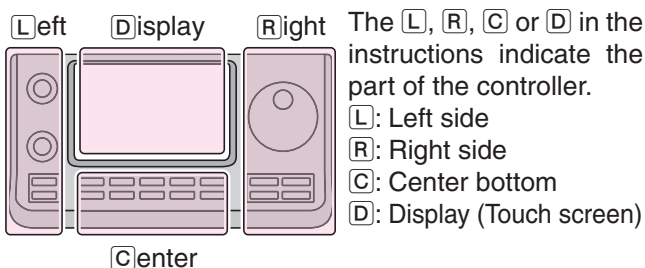

<b>Power ON</b> .....	<b>3-2</b>
◇ Before first applying power.....	3-2
◇ Tuning ON the power.....	3-2
<b>Selecting a Function menu</b> .....	<b>3-3</b>
<b>Selecting VFO/Memory mode</b> .....	<b>3-4</b>
<b>VFO operation</b> .....	<b>3-5</b>
◇ Selecting VFO A or VFO B.....	3-5
◇ VFO equalization.....	3-5
<b>Selecting a frequency band</b> .....	<b>3-6</b>
◇ Using the band stacking registers.....	3-6
<b>Setting frequency</b> .....	<b>3-7</b>
◇ Tuning with the Dial.....	3-7
◇ Quick Tuning function.....	3-8
◇ Selecting 'kHz' step.....	3-9
◇ Selecting 1 Hz step.....	3-9
◇ 1/4 tuning step function.....	3-10
◇ Auto tuning step function.....	3-10
◇ Direct frequency input.....	3-11
◇ Band edge warning beep.....	3-13
◇ Programming the user band edge.....	3-14
<b>Selecting the Operating mode</b> .....	<b>3-17</b>
<b>Selecting the Audio volume</b> .....	<b>3-18</b>
<b>Squelch and receive (RF) sensitivity</b> .....	<b>3-19</b>
<b>Voice synthesizer operation</b> .....	<b>3-20</b>
◇ Tuning OFF the S-meter announcement.....	3-21
◇ Tuning ON the MODE announcement.....	3-21
<b>Meter display selection</b> .....	<b>3-22</b>
<b>Basic transmit operation</b> .....	<b>3-23</b>
◇ Transmitting.....	3-23
◇ Microphone gain adjustment.....	3-24
<b>Weather channel operation (USA version only)</b> .....	<b>3-25</b>
◇ Weather channel selection.....	3-25
◇ Weather alert function.....	3-25
<b>For reference to USA version</b> .....	<b>3-26</b>
◇ About the 5 MHz frequency band operation (USA version only) .....	3-26

## Power ON

### ◇ Before first applying power

Before turning ON your transceiver for the first time, make sure all connections required for your system are complete by reviewing them in Section 2 of this manual.

After all connections have been made, set the [AF] (L) and [RF/SQL] (L) controls as shown in the illustration to the right.

**NOTE:** When turning OFF the power, the transceiver memorizes the settings. Thus the transceiver restarts with the settings before you turned OFF the power.

[RF/SQL] control: 12 o'clock

[AF] control: Max counterclockwise

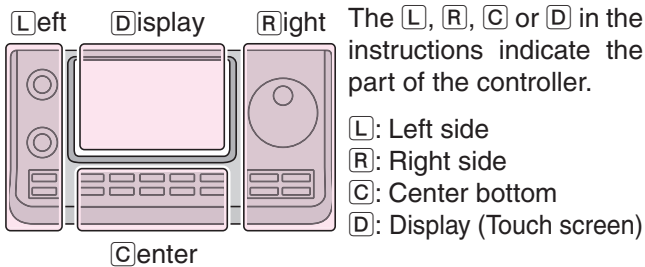

### ◇ Tuning ON the power

#### Normal Power ON:

Push [PWR] (L) to turn ON the transceiver.

#### Power OFF:

Hold down [PWR] (L) for 1 second to turn OFF the transceiver.

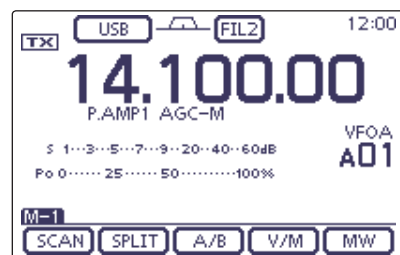
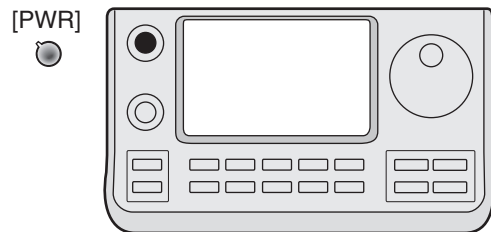

Initial VFO display

#### Partial Resetting

A partial resetting **CLEARs** the operating parameters and returns them to their default values (VFO frequency, VFO settings, menu group's contents) without clearing certain data.

[SET] (C) > Others > Reset > **Partial Reset**

- During start-up, the transceiver displays "PARTIAL RE-SET," then its initial VFO frequencies when resetting is complete.

See page 19-3 for resetting details.

## Selecting a Function menu

Push **MENU**(**C**) one or more times to select the “M-1” screen (M-1 menu), “M-2” screen (M-2 menu) or “M-3” screen (M-3 menu).

- In the DR mode, push **MENU**(**C**) once or twice to select the “D-1” screen (D-1 menu) or “D-2” screen (D-2 menu).
- Functions vary, depending on the operating mode. (p. 1-8 to p. 1-11)

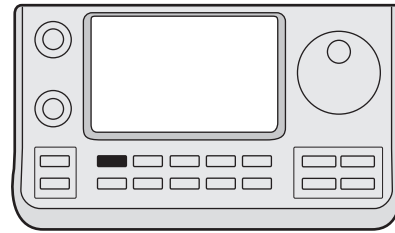

**MENU**

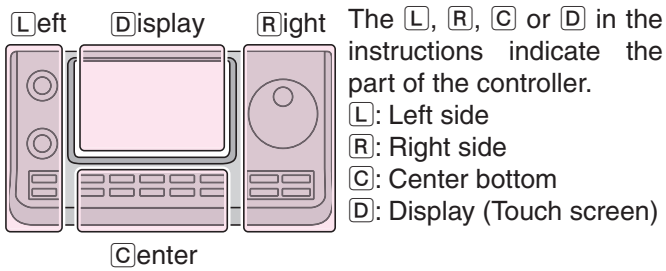

Example: Menu selection in the SSB mode

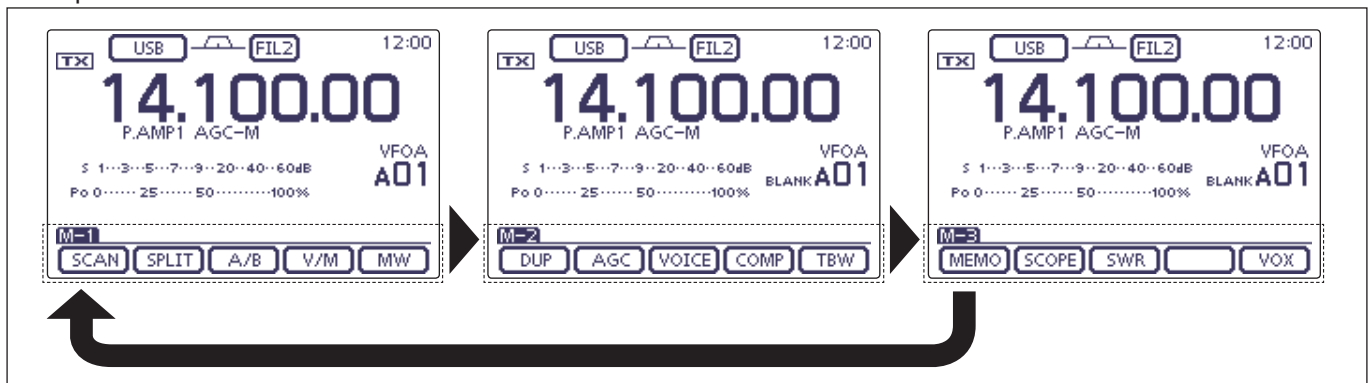

## Selecting VFO/Memory mode

IC-7100 has VFO and Memory modes.  
 In the VFO mode, rotate the Dial to select the desired frequency.  
 In the Memory mode, rotate [M-CH] (L) to select the preprogrammed memory channel.

Push **MENU** (C) one or more times to select the “M-1” screen (M-1 menu).

- Touch **[V/M]** (D) to select the VFO or memory mode.
- Touch **[V/M]** (D) for 1 second to copy the selected memory channel contents to the VFO mode. (p. 11-9)

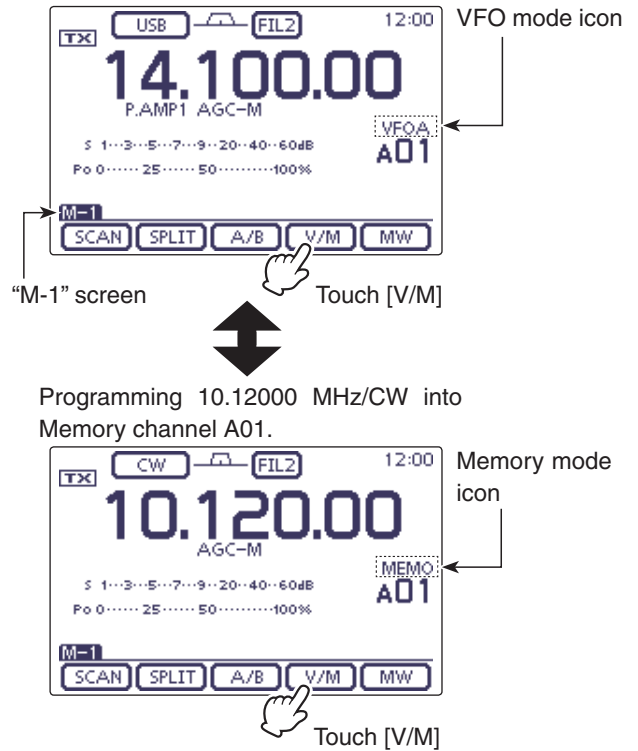

Touching the VFO/Memory mode icon or Memory channel selects the VFO or Memory mode.

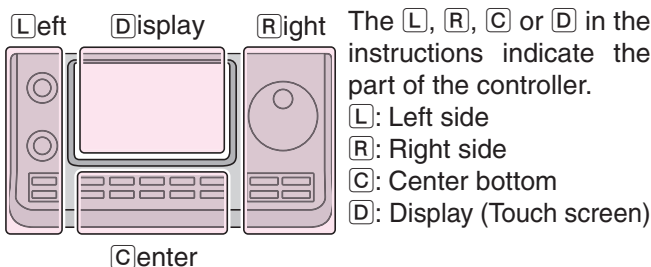
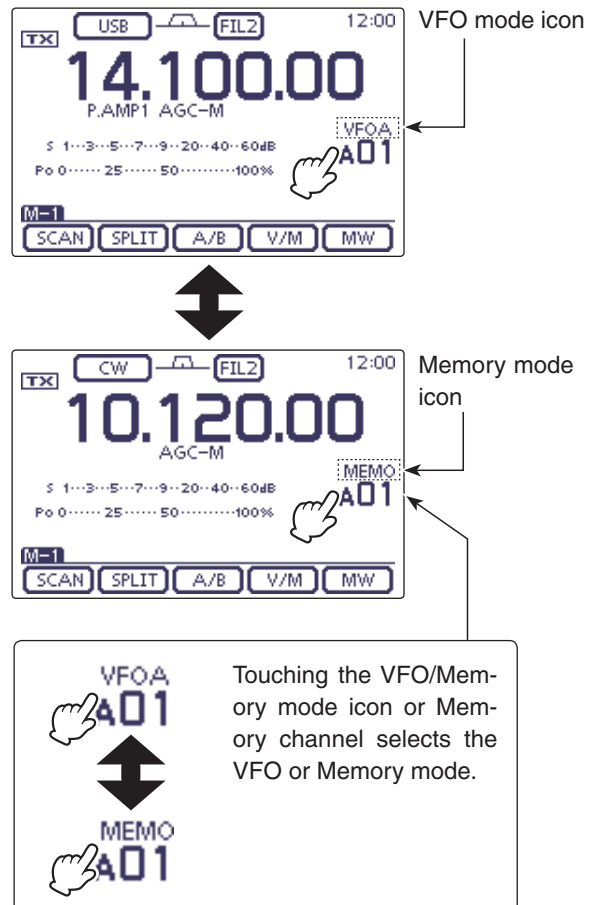

## VFO operation

The IC-7100 has two VFOs; “A” and “B,” and are convenient for quickly selecting two frequencies, or split frequency operation. You can use either VFO to call up a frequency and operating mode. VFO is an abbreviation of Variable Frequency Oscillator.

### ◇ Selecting VFO A or VFO B

- ① While in the VFO mode, push **MENU**(C) one or more times to select the “M-1” screen (M-1 menu).
- ② Touch **[A/B]**(D) to switch between the VFO A and VFO B.
  - “VFOA” or “VFOB” appears as each VFO is selected.

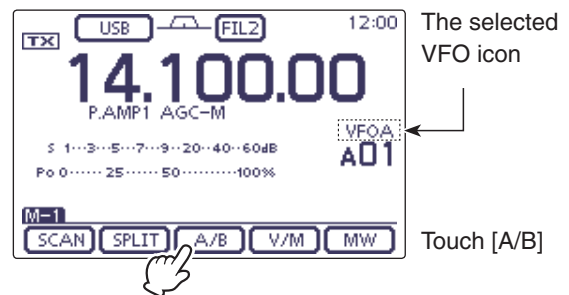
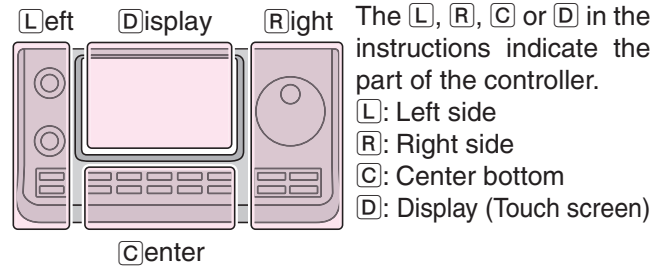

### ◇ VFO equalization

- ① Push **MENU**(C) one or more times to select the “M-1” screen (M-1 menu).
- ② Touch **[A/B]**(D) for 1 second to equalize the data in both VFOs.
  - Three beeps sound when the equalization is complete.
- ③ Touch **[A/B]**(D) to select the other VFO.
  - Selects VFO A or VFO B to display the VFO’s frequency.

Example: Equalize VFO B to VFO A

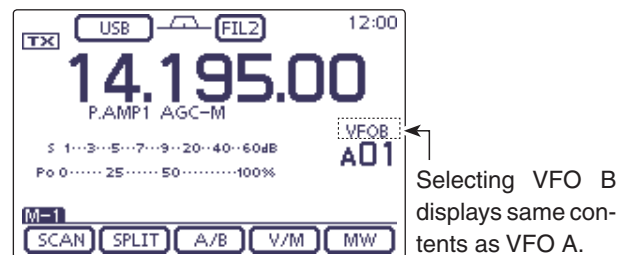
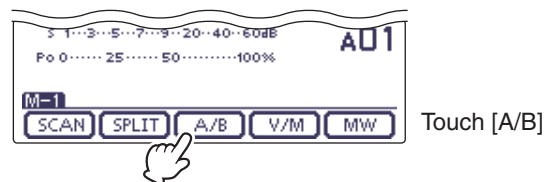
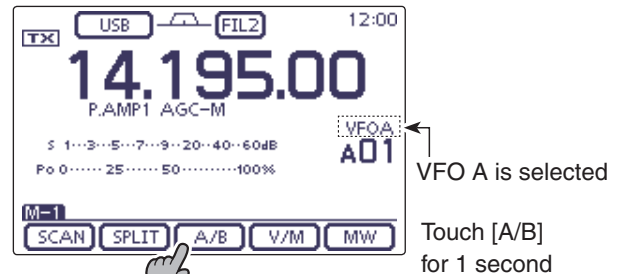

### CONVENIENT!

#### Use two VFOs as quick memories:

When you find a new station, but wish to continue searching, the dual VFO system can be used for quick memory storage.

- ① Touch **[A/B]**(D) for 1 second to store the displayed contents into the undisplayed VFO.
- ② Continue searching for stations.
- ③ Touch **[A/B]**(D) to show the stored contents of the undisplayed VFO.
- ④ To continue searching for stations, touch **[A/B]**(D) again to show the previous VFO.



## Selecting a frequency band

Select the frequency band you want to use.

- ① Touch the MHz digits of the frequency readout to enter the Band selection screen.
- ② Touch a desired operating band, “1.8” to “430” or “GENE.”
  - After touching the band, the display moves to the selected band, and returns to the frequency display.
  - Touch a band for 1 second to select the Band stacking register, Register 1, Register 2 or Register 3 on the Band selection screen.
  - Touch [F-INP] to enter the Direct input screen. (p. 3-11)
  - If desired, touch [↶](D) or push [MENU](C) to exit the screen.

### ◇ Using the band stacking registers

The triple band stacking register provides 3 memories for each band key to store frequencies and operating modes.

This function is convenient when you operate 3 operating modes on one frequency band.

For example, one register can be used for a CW frequency, another for an SSB frequency and the other one for an RTTY frequency.

If a band key or [GENE] is touched for 1 second once, the last used frequency and operating mode are called up. When the key is touched for 1 second again, another stored frequency and operating mode are called up.

See the table below for a list of the available frequency bands and their default frequency and mode settings.

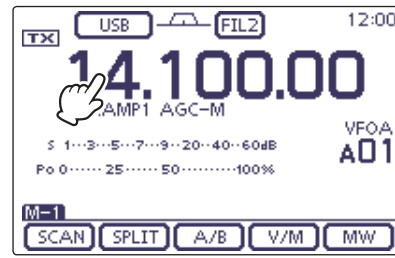

Touch the MHz digits.

#### • Band selection screen

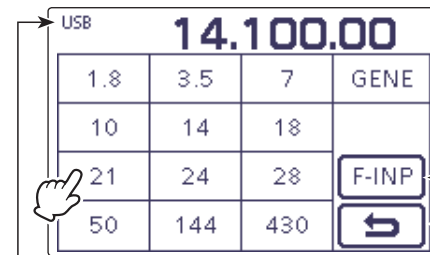

Enters the Direct input screen

Cancel edit

Operating mode

Example: Touch “21” in the above screen

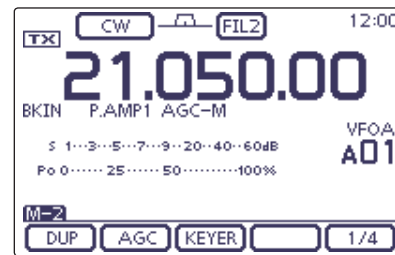

The **L**, **R**, **C** or **D** in the instructions indicate the part of the controller.

**L**: Left side, **R**: Right side, **C**: Center bottom  
**D**: Display (Touch screen)

BAND	REGISTER 1	REGISTER 2	REGISTER 3
1.8 MHz*1	1.900000 MHz CW	1.910000 MHz CW	1.915000 MHz CW
3.5 MHz*1	3.550000 MHz LSB	3.560000 MHz LSB	3.580000 MHz LSB
7 MHz	7.050000 MHz LSB	7.060000 MHz LSB	7.020000 MHz CW
10 MHz*1	10.120000 MHz CW	10.130000 MHz CW	10.140000 MHz CW
14 MHz	14.100000 MHz USB	14.200000 MHz USB	14.050000 MHz CW
18 MHz	18.100000 MHz USB	18.130000 MHz USB	18.150000 MHz USB
21 MHz	21.200000 MHz USB	21.300000 MHz USB	21.050000 MHz CW
24 MHz	24.950000 MHz USB	24.980000 MHz USB	24.900000 MHz CW
28 MHz	28.500000 MHz USB	29.500000 MHz USB	28.100000 MHz CW
50 MHz*1	50.100000 MHz USB	50.200000 MHz USB	51.000000 MHz FM
144 MHz	145.000000 MHz FM	145.100000 MHz FM	145.200000 MHz FM
430 MHz*1	433.000000 MHz FM	433.100000 MHz FM	433.200000 MHz FM
General*1, 2	15.000000 MHz USB	15.100000 MHz USB	15.200000 MHz USB

\*1 The default frequency and mode settings differ depending on the version. Above list shows the USA version's.

\*2 [GENE] selects the general coverage band.

## Setting frequency

You can select the transceiver's frequency by using the Dial, or you can enter it on the Direct input screen.

### ◇ Tuning with the Dial

- ① On the **Band** selection screen, select the desired frequency band. (p. 3-6)
- ② Rotate the Dial to set the desired frequency.
  - The default tuning step differs, depending on the operating mode, frequency band and a version.

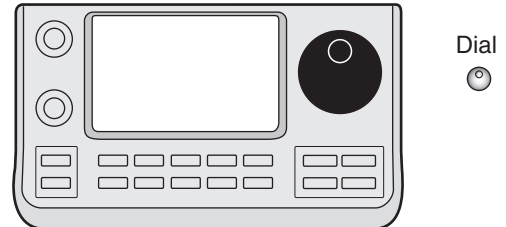

### If the frequency cannot be changed:

Check the Lock function, and if it is ON, "LOCK" is displayed, and the Dial does not function. In this case, hold down **[SPEECH/LOCK]**(R) for 1 second to turn OFF the Lock function.

When "LOCK/SPEECH" is selected in the "[SPEECH/LOCK] Switch" item of the "Function" Set mode, pushing **[SPEECH/LOCK]** turns OFF the lock function. (see p. 17-20 for details)

**[SET]**(C) > Function > **[SPEECH/LOCK] switch**

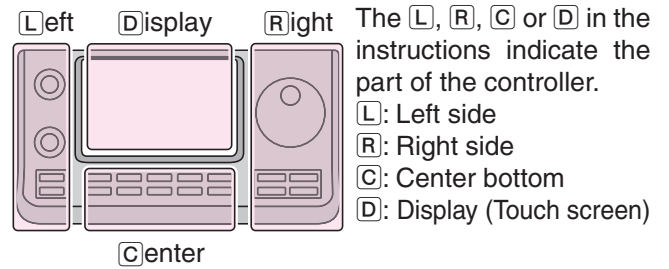

Setting frequency (Continued)

◇ Quick Tuning function

The operating frequency can be changed in 'kHz' or 'MHz' steps for quick tuning.

Select the desired tuning step in each operating frequency band and mode.

① Touch the kHz digits to select the 'kHz' Quick Tuning function step, or turn it OFF. Or touch the MHz digits for 1 second to select the 'MHz' Quick Tuning function step, or turn it OFF.

- While the quick tuning icon "▼" is displayed above the 1 kHz or 1 MHz digit, the frequency will be changed in 'kHz' or 'MHz' steps.

- When the function is OFF, the frequency will be changed in 10 Hz or 1 Hz steps.

② Rotate the Dial to change the frequency in the selected steps.

• 'kHz' Quick Tuning function

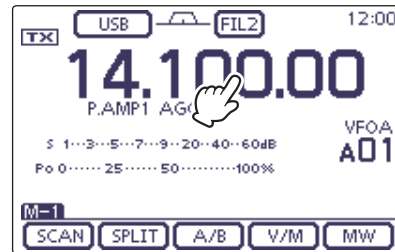

Touch the kHz digits

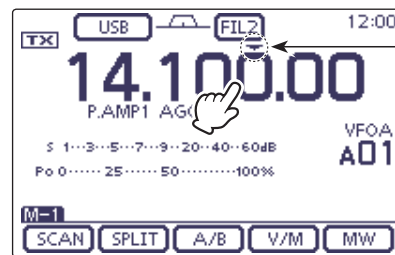

Quick tuning icon

Touch the kHz digits to turn it OFF

• 'MHz' Quick Tuning function

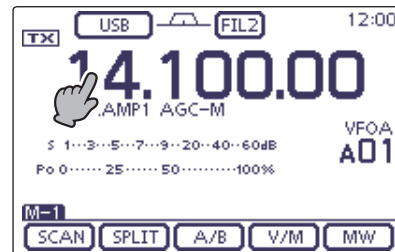

Touch the MHz digits for 1 second

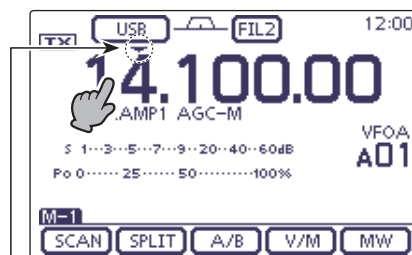

Touch the MHz digits for 1 second to turn it OFF

Quick tuning icon

Setting frequency (Continued)

◇ **Selecting 'kHz' step**

When the 'kHz' Quick Tuning is selected, the frequency can be changed in the selected 'kHz' steps. The steps can be memorized, depending on the operating modes.

- ① On the Mode selection screen, select the desired operating mode. (p. 3-17)
- ② Touch the kHz digits for 1 second to enter the Tuning step selection screen.
  - The 'kHz' Quick Tuning function is turned ON, and then the "▼" icon is displayed.
- ③ Touch the desired tuning step to select the desired 'kHz' step.
  - 0.1, 1, 5, 6.25, 9, 10, 12.5, 20, 25, 50 and 100 kHz are selectable.
  - If the desired step is not displayed, touch [▲] or [▼](D) to select the page.
  - On the Tuning step selection screen, rotating the Dial also selects the tuning step.
  - If desired, touch [↶](D) or push [MENU](C) to return to the normal operating screen.
- ④ Repeat steps ① to ③ to select the Quick tuning steps for other modes.

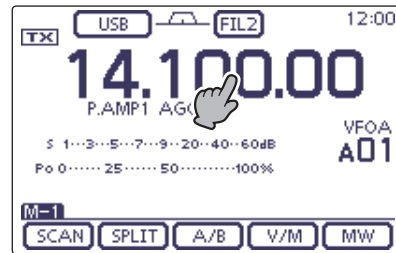

Touch the kHz digits for 1 second

• Tuning step selection screen

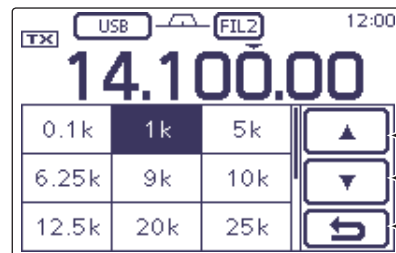

Selects pages  
Cancel edit

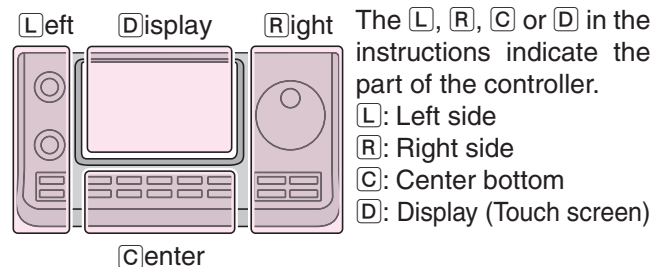

◇ **Selecting 1 Hz step**

You can change the frequency in 1 Hz steps for fine tuning.

- ➔ Touch the Hz digits for 1 second to turn the 1 Hz tuning step ON or OFF.

**NOTE:**

- When the RIT function is used, it also tunes in 1 Hz tuning steps.
- The frequency changes in 50 Hz steps when the [UP]/[DN] switches of the microphone are used for frequency tuning (if the quick tuning function is not selected.)

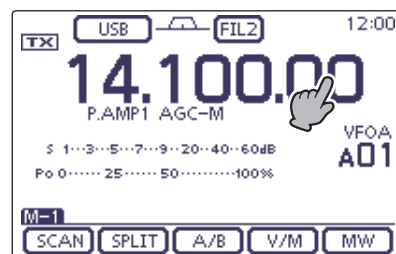

Touch the Hz digits for 1 second

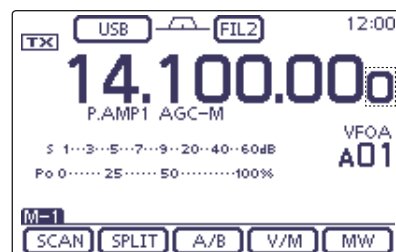

1 Hz indication

Setting frequency (Continued)

◇ 1/4 tuning step function

(Mode: SSB-D/CW/RTTY)

The dial speed is reduced to 1/4 of the normal speed when the 1/4 tuning function is ON, for finer tuning control.

You can set the 1/4 tuning function in each operating frequency band.

This function is selectable only when the quick tuning function is turned OFF.

- ① Push **MENU**(C) one or more times to select the "M-2" screen (M-2 menu).
- ② Touch [1/4](D) to turn the 1/4 tuning function ON or OFF.
  - "1/4" appears when the 1/4 tuning function is ON.

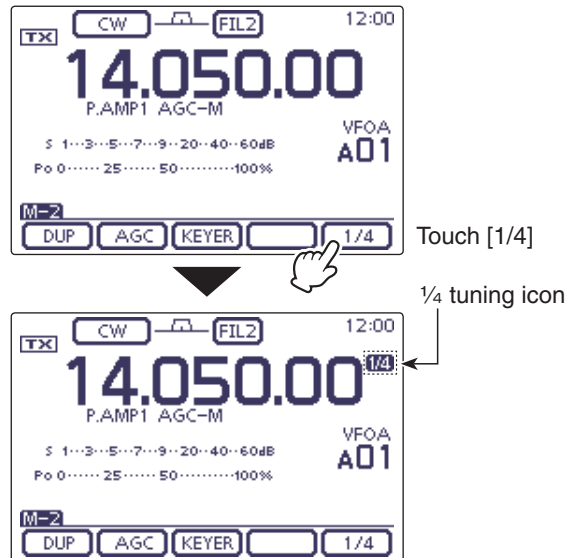

◇ Auto tuning step function

When you rapidly rotate the Dial, the tuning speed can automatically accelerate, depending on the "MAIN DIAL Auto TS" option in the "Function" Set mode.

- ① Push **SET**(C) to enter the Set mode.
- ② Touch the "MAIN DIAL Auto TS" item of the "Function" Set mode.
 

Function > **MAIN DIAL Auto TS**

  - If the specified item is not displayed, touch **▲** or **▼**(D) one or more times to select the page.
- ③ Touch the desired option to select the HIGH or LOW tuning speed acceleration, or to turn OFF the function.
  - HIGH: When the tuning step is set to 1 kHz or smaller steps, the tuning speed is approximately five times faster.  
When the tuning step is set to 5 kHz or larger steps, the tuning speed is approximately two times faster. (default)
  - LOW: Approximately two times faster
  - OFF: Auto tuning step is turned OFF.
  - If desired, touch the item for 1 second to open the Default set window, then select the "Default" to reset to the default setting.
- ④ Push **SET**(C) to exit the Set mode.

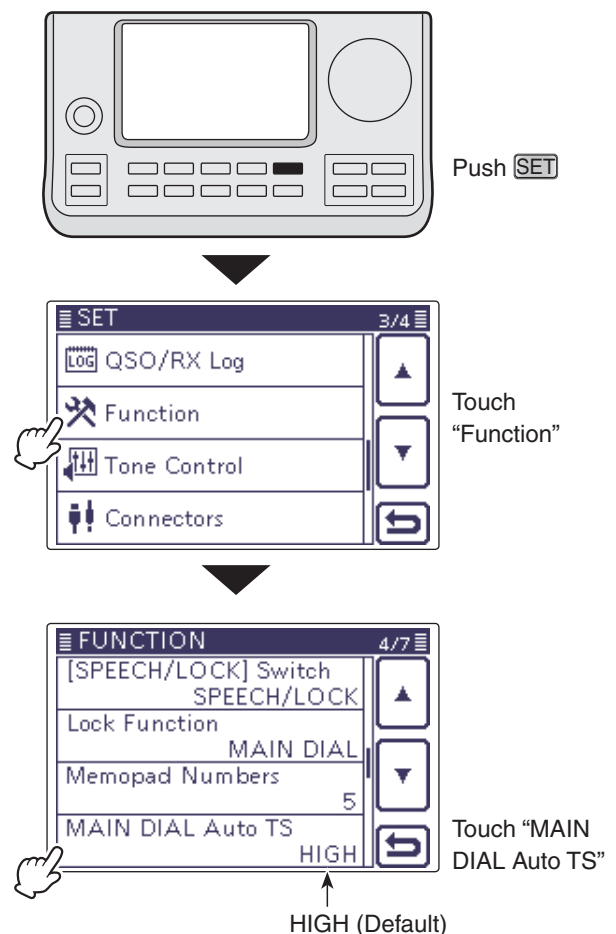

The **L**, **R**, **C** or **D** in the instructions indicate the part of the controller.  
**L**: Left side, **R**: Right side, **C**: Center bottom  
**D**: Display (Touch screen)

Setting frequency (Continued)

◇ Direct frequency input

The transceiver has a Direct input screen for direct frequency entry, as described below.

• Operating frequency input

- ① Touch the MHz digits to enter the **Band** selection display.
- ② Touch [F-INP](D) to enter the Direct input screen.
- ③ Touch the desired number to enter the desired frequency.
  - If a most significant digit is inputted, it will be displayed at the 10 Hz digit, and then next digit is inputted, a display will be shifted to left side one by one.
  - If the numbers for the MHz digits are inputted, and then "." is touched, the inputted numbers will be shifted to the MHz digits.
- ④ Touch [ENT](D) to input the frequency.
  - If a most significant digit is inputted, it will be displayed at the 10 Hz digit, and then next digit is inputted, a display shifts to left side one by one.
  - When not having inputted below a 100 kHz digit, touch [ENT](D) to set all uninputted digits to "0."
  - If desired, touch "CE" to delete entering.
  - If desired, touch [↵](D) or push [MENU](C) to exit the Direct input screen.

[Example]

To enter the 14.025 MHz frequency:

➔ Touch [1], [4], [• (-)], [0], [2], [5] then [ENT].

To enter the 18.0725 MHz frequency:

➔ Touch [1], [8], [• (-)], [0], [7], [2], [5] then [ENT].

To enter the 706 kHz frequency:

➔ Touch [0], [• (-)], [7], [0], [6] then [ENT].

To enter the 5.100 MHz frequency:

➔ Touch [5], [• (-)], [1] then [ENT].

To enter the 7.000 MHz frequency:

➔ Touch [7] then [ENT].

To change the 21.280 MHz to 21.245 MHz:

➔ Touch [• (-)], [2], [4], [5] then [ENT].

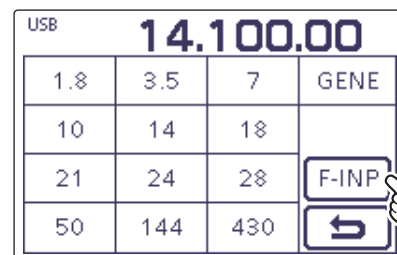
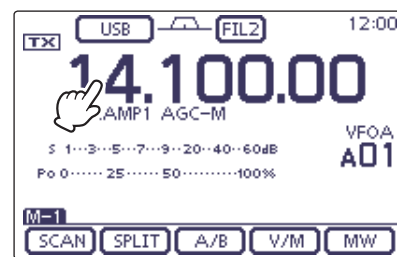
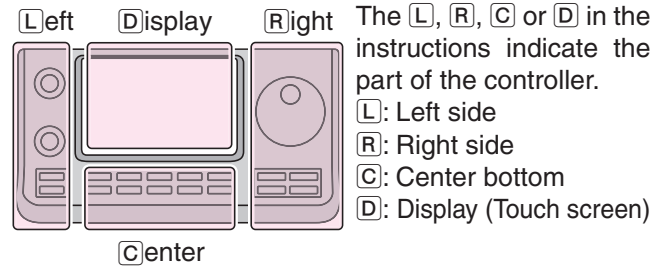

• Direct input screen

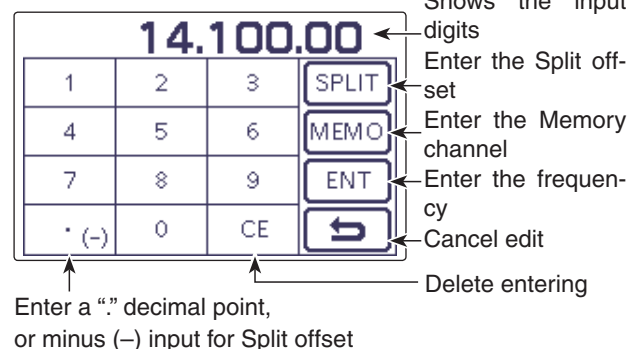

Setting frequency (Continued)

◇ Direct frequency input (Continued)

• Split offset frequency input

- ① Touch the MHz digits to enter the **Band** selection display.
- ② Touch [F-INP](**D**) to enter the Direct input screen.
- ③ If the Shift direction is minus, touch “• (-).”
  - [SPLIT] changes to [-SPLIT], and displays the Minus setting mode.
- ④ Touch the desired number to enter the desired frequency shift.
  - -9.999 to +9.999 MHz can be set in 1 kHz steps.
- ⑤ Touch [SPLIT] or [-SPLIT](**D**) to input the frequency shift to the transmit frequency, and the Split function is turned ON.

[Example]

To transmit on a 10 kHz higher frequency:

➔ Touch [1], [0] then [SPLIT].

To transmit on 1.025 MHz lower frequency:

➔ Touch [• (-)], [1], [0], [2], [5] then [-SPLIT].

• Memory channel selection

- ① Open the Direct input screen.
- ② Touch the desired memory channel number.
  - Selectable memory channels are 1 to 99 in the selected memory bank A to E.
  - The memory channels in the other memory banks cannot be selected.
  - **Scan edge** channels and Call channels can also be selected. (Shown in the table to the right below.)
- ③ Touch [MEMO](**D**) to select the channel.
  - The selected memory channel is displayed, and then exit the Direct input screen.
  - If desired, touch “CE” to delete the entered digits.
  - If desired, touch [↵](**D**) or push [MENU](**C**) to exit the Direct input screen.

[Example]

To select the Memory channel 24:

➔ Touch [2], [4] then [ENT].

To select the Scan edge channel 1B:

➔ Touch [1], [0], [1] then [ENT].

To select the CALL2 channel on the 430 MHz band:

➔ Touch [1], [0], [9] then [ENT].

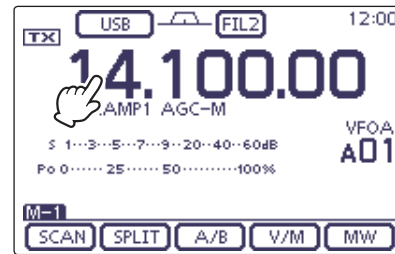

Touch the MHz digits

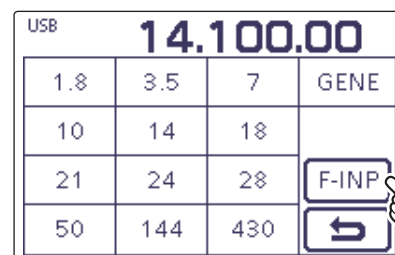

Touch [F-INP]

• Direct input screen

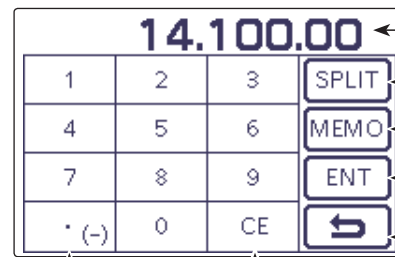

Shows the input digits  
 Enter the Split offset  
 Enter the Memory channel  
 Enter the frequency  
 Cancel edit  
 Delete entering

Enter a “.” decimal point, or minus (-) input for Split offset

• Scan edge channels and Call channels

	Channel	Input	Channel	Input
Scan edge channels	1A	100	1B	101
	2A	102	2B	103
	3A	104	3B	105
Call channels	144 MHz CALL1	106	144 MHz CALL2	107
	430 MHz CALL1	108	430 MHz CALL2	109

The **L**, **R**, **C** or **D** in the instructions indicate the part of the controller.

**L**: Left side, **R**: Right side, **C**: Center bottom  
**D**: Display (Touch screen)

Setting frequency (Continued)

◇ **Band edge warning beep**

You can hear a beep tone when you tune into or out of an amateur band's frequency range. A regular beep sounds when you tune into a range, and an lower tone error beep sounds when you tune out of a range.

- ① Push **SET**(**C**) to enter the Set mode.
- ② Touch the "Band Edge Beep" item of the "Function" Set mode.

Function > **Band Edge Beep**

- If the specified item is not displayed, touch [**▲**] or [**▼**](**D**) one or more times to select the page.

- ③ Touch the desired option to select the desired band edge warning beep setting, or to turn OFF the function.

- OFF: Band edge beep is OFF.
- ON (Default): When you tune into or out of the default amateur band's frequency range, a beep sounds.
- ON (User): When you tune into or out of a user programmed amateur band's frequency range, a beep sounds.
- ON (User) & TX Limit: When you tune into or out of a user programmed amateur band's frequency range, a beep sounds. Also transmission is inhibited outside the programmed range.

- If desired, touch the item for 1 second to open the Default set window, then select the "Default" to reset to the default setting.

- ④ Push **SET**(**C**) to exit the Set mode.

▨ If the "Beep Level" item is set to "0," the Band edge beep does not sound. The beep output level can be set in the "Beep Level" item of the "Function" Set mode. (p. 17-18)

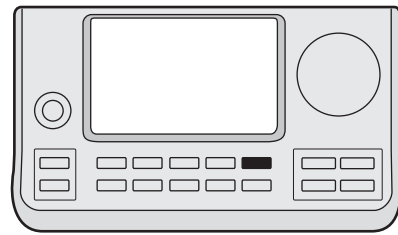

Push **SET**

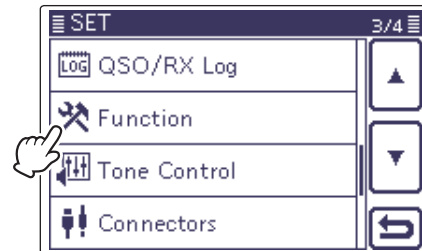

Touch "Function"

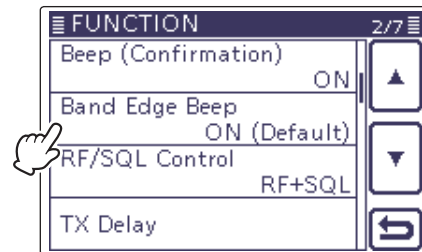

Touch "Band Edge Beep"

**About the user band edge frequencies**

When "ON (User)" or "ON (User) & TX Limit" is selected in the "Band Edge Beep" item, a total of 30 band edge frequencies can be programmed in the "User Band Edge" item. See the next page for details.

If "OFF" or "ON (Default)" is selected, the "User Band Edge" item does not appear in the "Function" Set mode.

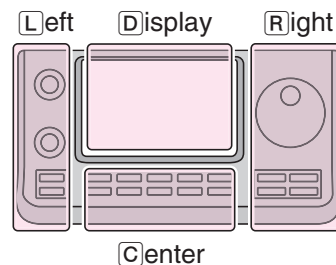

The **L**, **R**, **C** or **D** in the instructions indicate the part of the controller.

- L**: Left side
- R**: Right side
- C**: Center bottom
- D**: Display (Touch screen)



Setting frequency (Continued)

◇ Programming the user band edge

When “ON (User)” or “ON (User) & TX Limit” is selected in the “Band Edge Beep” item, the “User Band Edge” item appears in the “Function” Set mode.

A total of 30 band edge frequencies can be programmed in the “User Band Edge” item.

**NOTE:**

- All frequency ranges are set to default, so you should delete or change them to add the desired band edge frequency.
- Program each channel from left to right and each frequency must be higher than the preceding frequency.
- The frequency that is duplicated, or out of a transmit frequency range, cannot be programmed.

- ① Push **SET**(C) to enter the Set mode.
- ② Touch the “Band Edge Beep” item of the “Function” Set mode.  
Function > **Band Edge Beep**  
• If the specified item is not displayed, touch [▲] or [▼](D) one or more times to select the page.
- ③ Touch the “ON (USER)” or “ON (User) & TX Limit” option.
- ④ Touch the “User Band Edge” item of the “Function” Set mode.  
Function > **User Band Edge**
- ⑤ Follow the instructions in the next topics to delete, insert, edit, change or reset Band edges.
- ⑥ After you have finished, push **SET**(C) to exit the Set mode.

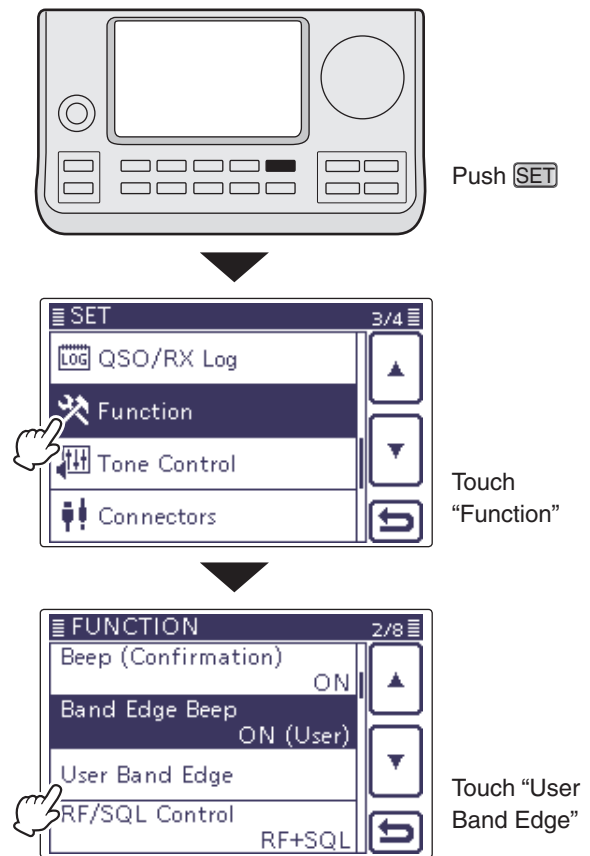

• Deleting a Band edge

- ① Enter the “User Band Edge” screen.  
**SET**(C) > Function > **User Band Edge**
- ② Touch for 1 second the Band edge to be deleted.  
• If the specified band edge is not displayed, touch [▲] or [▼](D) one or more times to select the page.
- ③ Touch “Delete.”  
• The selected Band edge has been deleted, and then returns to the User Band Edge screen.
- ④ Touch [↵](D) or push **MENU**(C) to return to the “Function” Set screen.

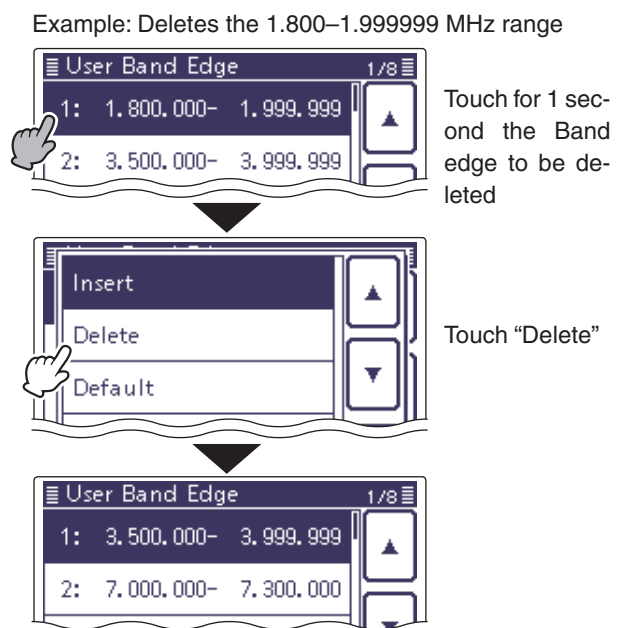

The **L**, **R**, **C** or **D** in the instructions indicate the part of the controller.  
**L**: Left side, **R**: Right side, **C**: Center bottom  
**D**: Display (Touch screen)

Setting frequency (Continued)

◇ Programming the user band edge (Continued)

• Inserting a Band edge

- ① Enter the "User Band Edge" screen.  
 [SET](C) > Function > **User Band Edge**
- ② Touch for 1 second the Band edge that you want to insert a new Band edge above it.
  - If the desired Band edge is not displayed, touch [▲] or [▼](D) one or more times to select the page.
- ③ Touch "Insert."
  - The frequency entry screen is displayed.
- ④ Touch desired numbers to edit the lower edge frequency, and then touch [ENT](D).
  - The cursor moves to the upper frequency entry, and a same frequency as lower frequency is automatically input.
  - Touch [◀ ▶](D) to toggle the lower or upper frequency entry.
  - Touch [←] or [→](D) to move the cursor left or right.
  - Before entering the frequencies, touch [↵](D) or push [MENU](C) to insert a blank field.
- ⑤ Touch desired numbers to edit the upper edge frequency, and then touch [ENT](D).
- ⑥ Touch [↵](D) or push [MENU](C) to return to the "Function" Set screen.

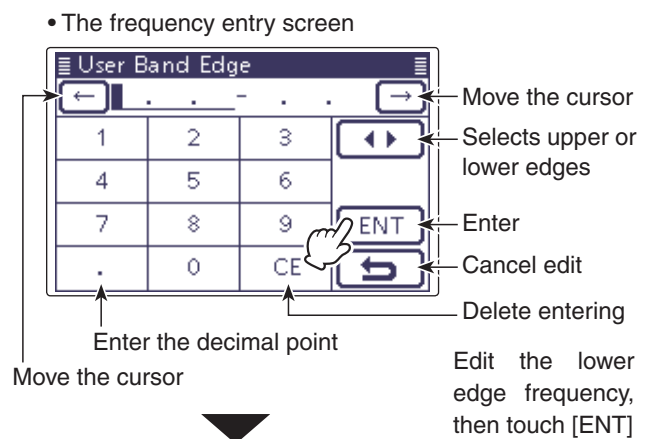
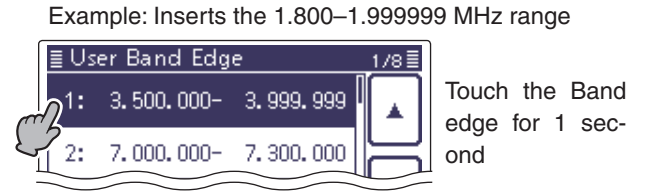

• Editing a new Band edge

- ① Enter the "User Band Edge" screen.  
 [SET](C) > Function > **User Band Edge**
- ② Touch a blanked field.
  - If the desired blank field is not displayed, touch [▲] or [▼](D) one or more times to select the page.
  - The frequency entry screen is displayed.
- ③ Touch desired numbers to edit the lower edge frequency, and then touch [ENT](D).
  - The cursor moves to the upper frequency entry, and a same frequency as lower frequency is automatically input.
  - Touch [◀ ▶](D) to toggle the lower or upper frequency entry.
  - Touch [←] or [→](D) to move the cursor left or right.
- ④ Touch desired numbers to edit the upper edge frequency, and then touch [ENT](D).
- ⑤ Touch [↵](D) or push [MENU](C) to return to the "Function" Set screen.

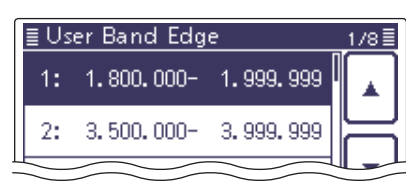
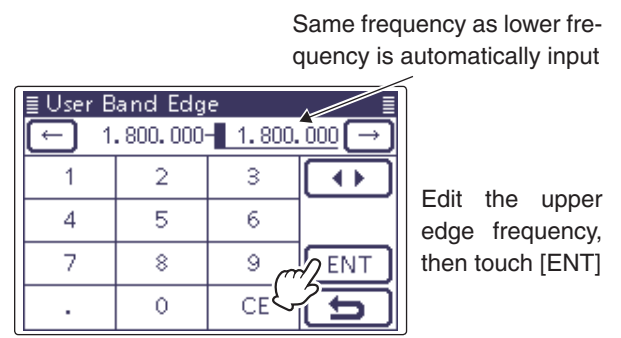

The L, R, C or D in the instructions indicate the part of the controller.  
 L: Left side, R: Right side, C: Center bottom  
 D: Display (Touch screen)

Setting frequency (Continued)

◇ Programming the user band edge (Continued)

• **Changing the Band edge frequencies**

- ① Enter the "User Band Edge" screen.  
 [SET](C) > Function > **User Band Edge**
- ② Touch the Band edge to be changed.
  - If the desired Band edge is not displayed, touch [▲] or [▼](D) one or more times to select the page.
  - The frequency entry screen is displayed.
- ③ Touch desired numbers to edit the lower edge frequency, and then touch [ENT](D).
  - The cursor moves to the upper frequency entry.
  - Touch [◀▶](D) to toggle the lower or upper frequency entry.
  - Touch [←] or [→](D) to move the cursor left or right.
- ④ Touch desired numbers to edit the upper edge frequency, and then touch [ENT](D).
- ⑤ Touch [↵](D) or push [MENU](C) to return to the "Function" Set screen.

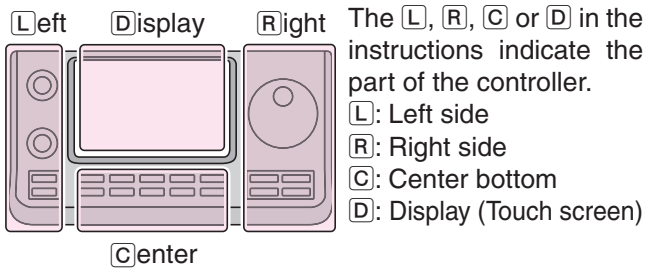

Example: Change the 7.000–7.300000 MHz range



• The frequency entry screen

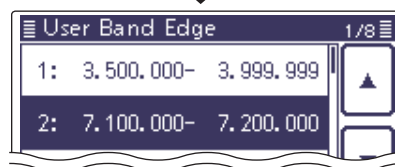
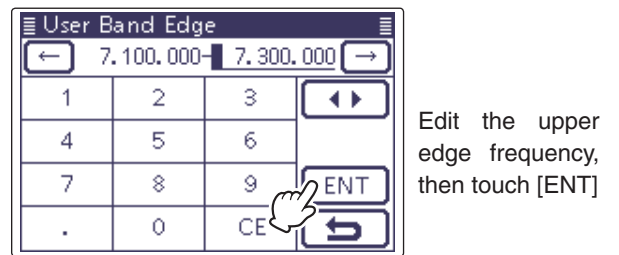
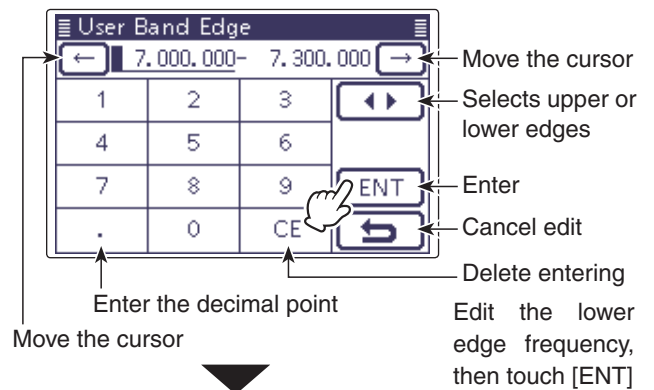

• **Resetting the Band edges**

- ① Enter the "User Band Edge" screen.  
 [SET](C) > Function > **User Band Edge**
- ② Touch any band edges for 1 second.
- ③ Touch "Default."  
 • "Initialize Edges?" is displayed.
- ④ Touch [YES](D).  
 • Resets all band edge frequencies to default settings.  
 • If desired, touch "NO" to cancel resetting.
- ⑤ Touch [↵](D) or push [MENU](C) to return to the "Function" Set screen.

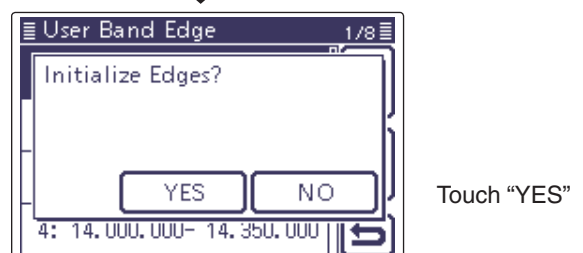

## Selecting the Operating mode

The usable operating modes in the IC-7100 are listed to the right below.

You can select the desired operating mode by touching the mode key on the Mode selection screen.

**NOTE:**

In the AM mode, you can transmit on only the HF, 50/70\* MHz frequency bands.

\* 70 MHz band transmission is available, depending on the transceiver version.

- ① Touch the Mode icon to enter the Mode selection screen.
- ② Touch an operating mode, "SSB," "CW," "RTTY," "AM," "FM," "WFM" or "DV."
  - Touch the Operating mode to select the operating mode as shown in the 'Operating mode selection list.'
  - After touching, the display exits the Operating mode selection screen and returns to the previous screen.
  - While in the SSB, AM or FM mode "DATA" appears on the Mode selection screen. Touch "DATA" to select the SSB data, AM data or FM data modes.
  - If desired, touch [↶](D) or push [MENU](C) to exit the Mode selection screen.

**• Selecting the SSB mode**

- When operating above 10 MHz, USB is selected first; when operating below 10 MHz, LSB is selected first.
- In the SSB mode, touch "SSB" again to toggle between the LSB and USB modes.

**• Selecting the CW/CW-R modes**

- The CW reverse mode may reduce the interfering tone when it is near a desired signal.
- In the CW mode, touch "CW" again to toggle between the CW and CW-R modes.

**• Selecting the RTTY/RTTY-R modes**

- In the RTTY mode, touch "RTTY" again to toggle between the RTTY and RTTY-R modes.

**• Selecting the DV mode (including DR mode)\***

- DV mode (digital voice + low-speed data communication) allows you to exchange text messages and call signs, and transmit position data with a third-party GPS receiver.
- The DV mode is automatically selected when the DR mode is ON.

**• Selecting the Data mode**

You can mute the microphone signals when the data mode is selected, depending on the "DATA MOD" option in the "Connectors" Set mode (p. 17-24).

[SET](C) > Connectors > **DATA MOD**

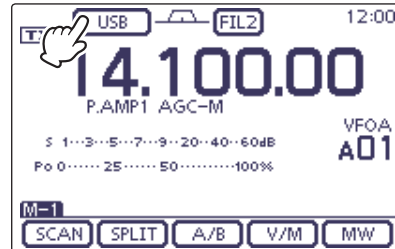

Touch the Mode icon

• Mode selection screen

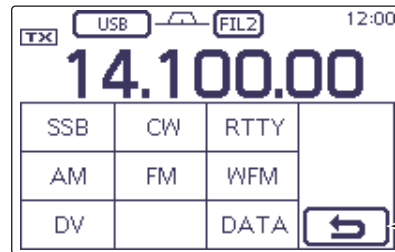

Cancel

• Operating mode selection list

Mode selection	Operating mode	
SSB	LSB	USB
CW	CW	CW-R
RTTY	RTTY	RTTY-R
AM	AM*	
FM	FM	
WFM	WFM (Only RX)	
DV	DV	
DATA	LSB	LSB data
	USB	USB data
	AM	AM data
	FM	FM data

\* On the 144 MHz or 430 MHz bands, only the RX operation is available in the AM mode.

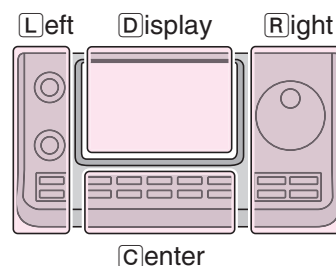

The L, R, C or D in the instructions indicate the part of the controller.

L: Left side

R: Right side

C: Center bottom

D: Display (Touch screen)

Center

## Selecting the Audio volume

➔ Rotate [AF] (L) control clockwise to increase the audio output level, counterclockwise to decrease it.

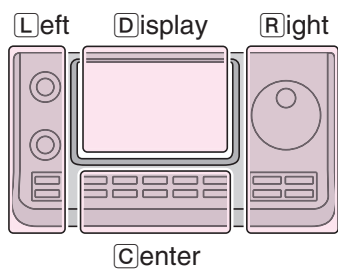
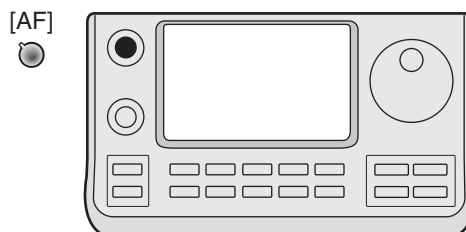
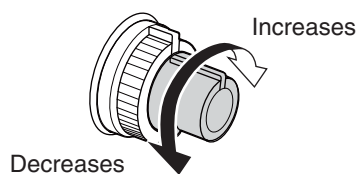

The **L**, **R**, **C** or **D** in the instructions indicate the part of the controller.

- L**: Left side
- R**: Right side
- C**: Center bottom
- D**: Display (Touch screen)

## Squelch and receive (RF) sensitivity

Adjusts the RF gain and squelch threshold level. The squelch removes noise output to the speaker when no signal is received (closed squelch).

- The squelch is particularly effective for AM and FM, but also works in other modes.
- The 12 to 1 o'clock position is recommended for the most effective use of the [RF/SQL] (L) control.
- The [RF/SQL] (L) control operates as only an RF gain control (Squelch is fixed open), or a squelch control (RF gain is fixed at maximum **sensitivity** depending on the "RF/SQL Control" option in the "Function" Set mode. (p. 17-18) **SET** > Function > **RF/SQL Control**

SET MODE SETTING	OPERATING MODE	[RF/SQL] OPERATION
AUTO	AM/FM/WFM/DV	Operates as only a squelch control. • RF gain is fixed at maximum sensitivity.
	SSB/CW/RTTY	Operates as only an RF gain control. • Squelch is fixed open.
SQL	ALL	Operates as only a squelch control. • RF gain is fixed at maximum sensitivity.
RF+SQL (default)	FM/DV	Operates as an RF gain control, and a noise squelch or S-meter squelch.
	SSB/CW/RTTY/AM/WFM	Operates as an RF gain control, and an S-meter squelch.

### ○ Adjusting RF gain (Receive sensitivity)

Normally, [RF/SQL] (L) is set to the 12 o'clock position.

Rotate [RF/SQL] (L) to the 11 o'clock position for maximum sensitivity.

- Rotating counterclockwise from the maximum position reduces sensitivity.
- The S-meter indicates receive sensitivity.

While rotating the RF gain control, a faint noise may be heard. This comes from the **DSP** unit and does not indicate an equipment malfunction.

### ○ Adjusting squelch (Removing non-signal noise)

Rotate [RF/SQL] (L) clockwise when no signal is received, until the noise just disappears.

- The TX/RX LED light goes out.
- Rotating [RF/SQL] (L) past the threshold point activates the S-meter squelch— this allows you to set a minimum signal level needed to open the squelch.

The **L**, **R**, **C** or **D** in the instructions indicate the part of the controller.

- L**: Left side, **R**: Right side, **C**: Center bottom
- D**: Display (Touch screen)

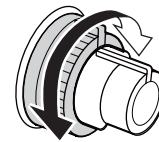
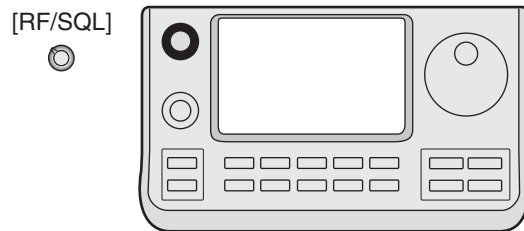

#### • When used as an RF gain/squelch control

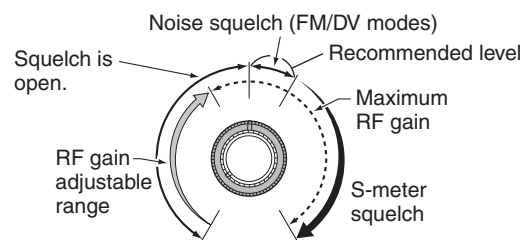

#### • When used as an RF gain control (Squelch is fixed open; SSB, CW, RTTY only)

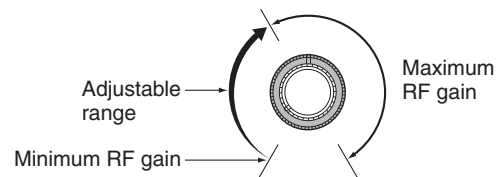

#### • When used as a squelch control (RF gain is fixed at maximum.)

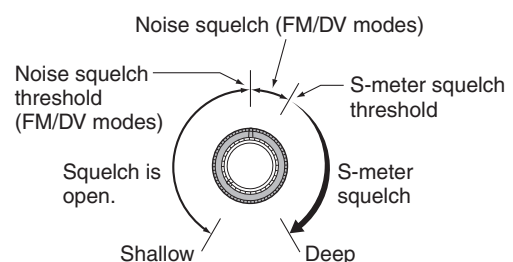

## Voice synthesizer operation

The IC-7100 has a built-in voice synthesizer to announce the operating frequency, mode and S-meter level in a clear, electronically-generated voice, in English or Japanese.

First, select the desired parameters to be announced in the "Speech" Set mode. (p. 17-15)

### Initial values for the voice synthesizer parameters

- RX Call Sign SPEECH: ON (Kerchunk)
  - RX>CS SPEECH: ON
  - S-Level SPEECH: ON
  - MODE SPEECH: OFF
  - SPEECH Language: English
  - Alphabet: Normal
  - SPEECH Speed: Fast
  - SPEECH Level: 50%
  - [SPEECH/LOCK] Switch: SPEECH/LOCK\*
- \*See **NOTE** as described below.

➔ Push [SPEECH/LOCK] to announce the currently selected frequency, mode and S-meter level\*.

\* The S-meter level announcement can be turned OFF. (p. 17-15)

**NOTE:** If "SPEECH/LOCK" is not selected in the "[SPEECH/LOCK] Switch" item of the "Function" Set mode, you should hold down **[SPEECH/LOCK]** (R) for 1 second to activate the voice synthesizer.

➔ Push a mode switch to announce the appropriate mode, when the "MODE SPEECH" item is set to "ON" in the "SPEECH" Set mode. (p. 17-15)

**[SET]**(C) > SPEECH > **MODE SPEECH**

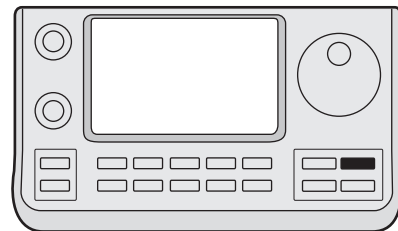
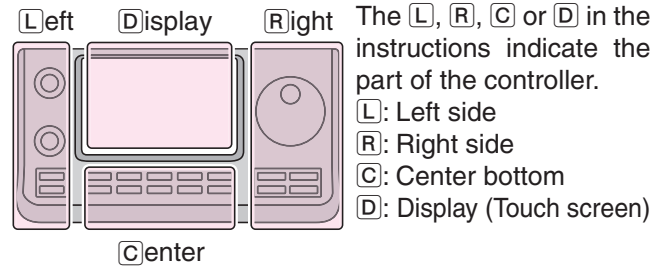

**[SPEECH/LOCK]**

Voice synthesizer operation (Continued)

◇ Tuning OFF the S-meter announcement

The S-meter announcement can be turned OFF.

- ① Push **SET**(C) to enter the Set mode.
- ② Touch the "S-Level SPEECH" item of the "SPEECH" Set mode.  
 SPEECH > **S-Level SPEECH**
  - If the specified item is not displayed, touch **[▲]** or **[▼]**(D) one or more times to select the page.
- ③ Touch the option to turn OFF the function.
- ④ Push **SET**(C) to exit the Set mode.

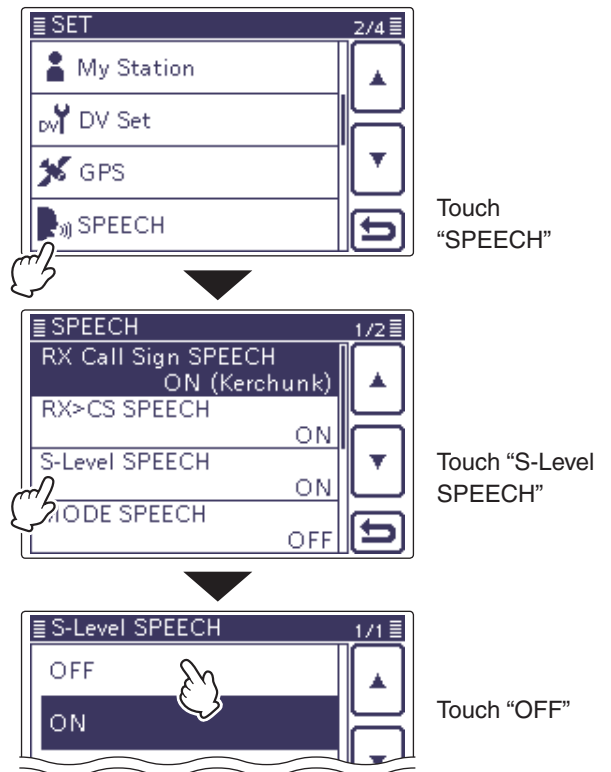

◇ Tuning ON the MODE announcement

When this function is ON, the selected operating mode is verbally announced when a mode is selected.

- ① Push **SET**(C) to enter the Set mode.
- ② Touch the "MODE SPEECH" item of the "SPEECH" Set mode.  
 SPEECH > **MODE SPEECH**
  - If the specified item is not displayed, touch **[▲]** or **[▼]**(D) one or more times to select the page.
- ③ Touch the option to turn ON the function.
- ④ Push **SET**(C) to exit the Set mode.

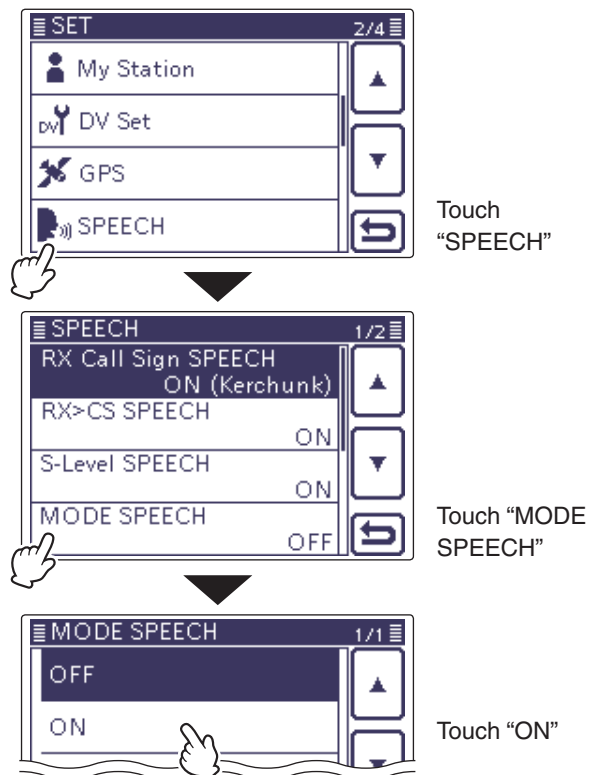



## Meter display selection

The transmit meter can be toggled between four functions for your convenience.

- Touch the Meter one or more times to select the TX meter function, RF power meter, SWR meter, **ALC** meter or COMP meter.
  - Po : Displays the relative RF output power.
  - SWR : Displays the SWR of the antenna at the frequency.
  - ALC : Displays the ALC level. When the meter movement shows the input signal level exceeds the allowable level, the ALC limits the RF power. In such cases, decrease the microphone gain level.
  - COMP : Displays the compression level when the speech compressor is in use.
- Touch the Meter for 1 second to select the Multi-function meter.
  - Touch the Multi-function meter to cancel the meter.

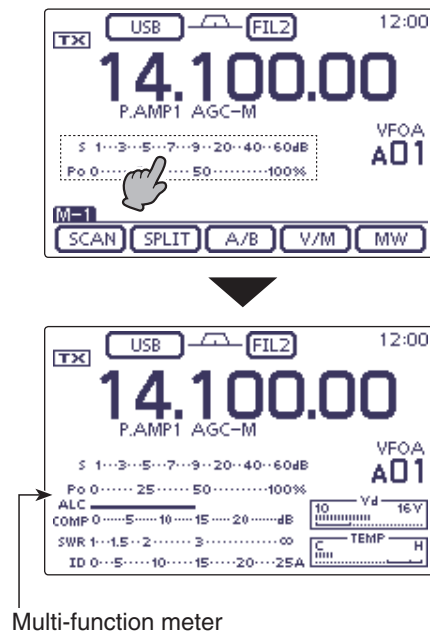
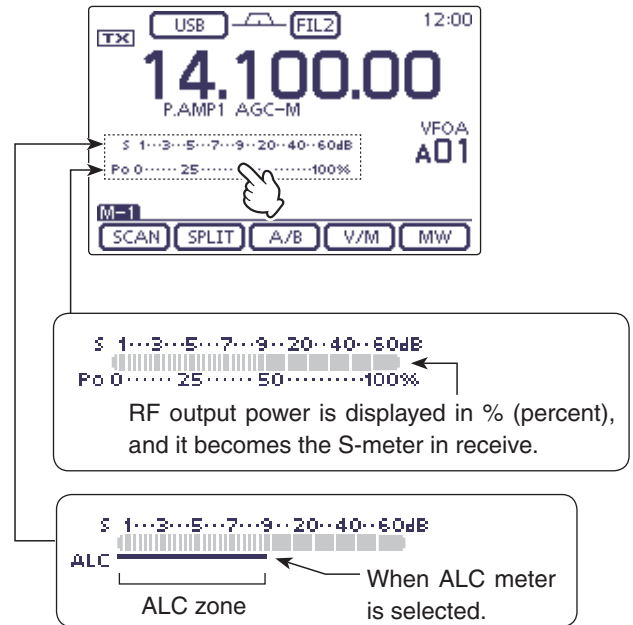

## Basic transmit operation

Before transmitting, monitor the operating frequency to make sure transmitting won't cause interference to other stations on the same frequency. It's good amateur practice to listen first, and then, even if nothing is heard, ask "Is the frequency in use?" once or twice, before you begin operating on that frequency.

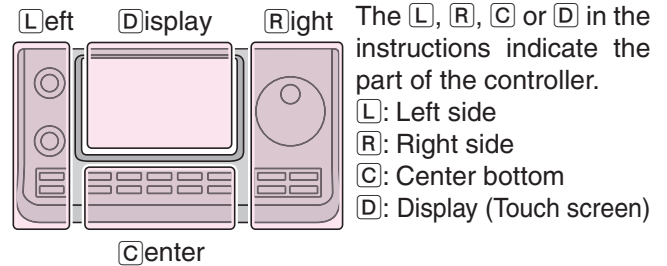

### ◇ Transmitting

**CAUTION:** Transmitting without an antenna may damage the transceiver.

In the AM mode, you can transmit on only the HF, 50/70\* MHz frequency bands.

\* 70 MHz band transmission is available, depending on the transceiver version.

- ① Push [PTT] on the microphone to transmit (or external transmit switch).
  - The TX/RX LED lights red.
- ② Release [PTT] again to receive (or external transmit switch).

### ✓ Adjusting the transmit output power

- ① Push [MIC/RF PWR](C) to open the MIC gain/RF power adjustment display.
- ② Rotate [BANK](L) to adjust the RF power.
- ③ Push [MENU](C) to close the display.

Frequency band	RF output power range
HF/50 MHz	2 to 100 W (AM: 1 to 30 W)
70 MHz*	2 to 50 W (AM: 1 to 15 W)
144 MHz	2 to 50 W
430 MHz	2 to 35 W

\* 70 MHz band transmission is available, depending on the transceiver version.

**NOTE:** The RF output power settings are independently memorized in the HF, 50, 70, 144 and 430 MHz bands.

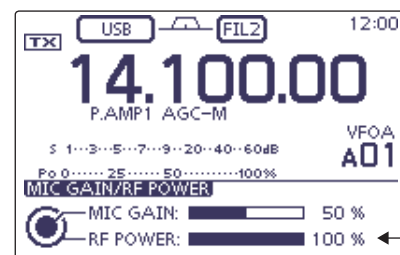
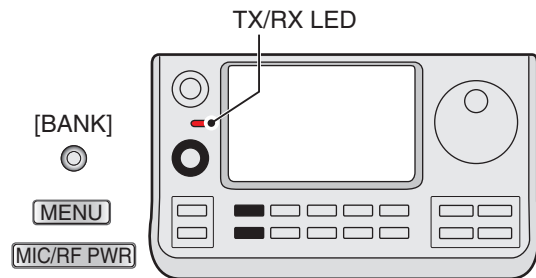

Output power adjustment

Basic transmit operation (Continued)

◇ **Microphone gain adjustment**  
(Mode: SSB/AM/FM/DV)

- ① Push [MIC/RF PWR] (C) to open the MIC gain/RF power adjustment display.
- ② Push [PTT] to transmit.
  - Speak into the microphone at your normal voice level.
- ③ Rotate [M-CH] (L) to adjust the MIC gain.
  - ▨ When the MIC gain is adjusted too high, your transmitted voice may be distorted.
- ④ Release [PTT] to receive.
- ⑤ Push [MENU] (C) to close the display.

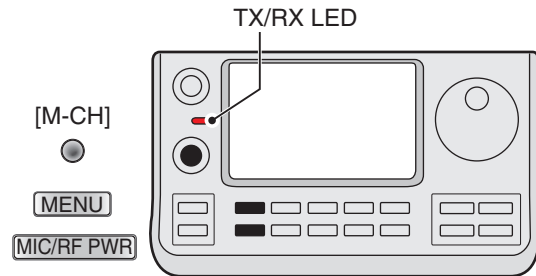

○ **In the SSB mode:**

Touch the TX meter to select the **ALC** meter. Then, while speaking into the microphone, rotate [M-CH] (L) so that the ALC meter reading stays within the ALC zone.

○ **In the AM, FM and DV modes:**

While speaking into the microphone, rotate [M-CH] (L) with another station listening to your voice for clarity.

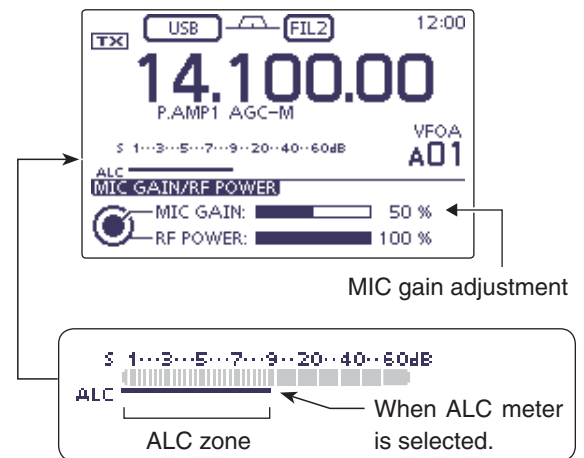

## Weather channel operation (USA version only)

There are 10 weather channels for monitoring weather channels from the NOAA (National Oceanographic and Atmospheric Administration) broadcasts.

### ◇ Weather channel selection

- ① Push **QUICK**(C) to open the Quick Menu window.
- ② Touch "Weather CH" to select the Weather channel mode.
  - "WX" and the weather channel number appear.
  - If the specified item is not displayed, touch [▲] or [▼](D) to select the page.
- ③ Rotate [M-CH]●(L) to select the desired weather channel.
  - If desired, touch "Weather CH OFF" on the Quick Menu screen to return to the previous frequency or Memory channel.

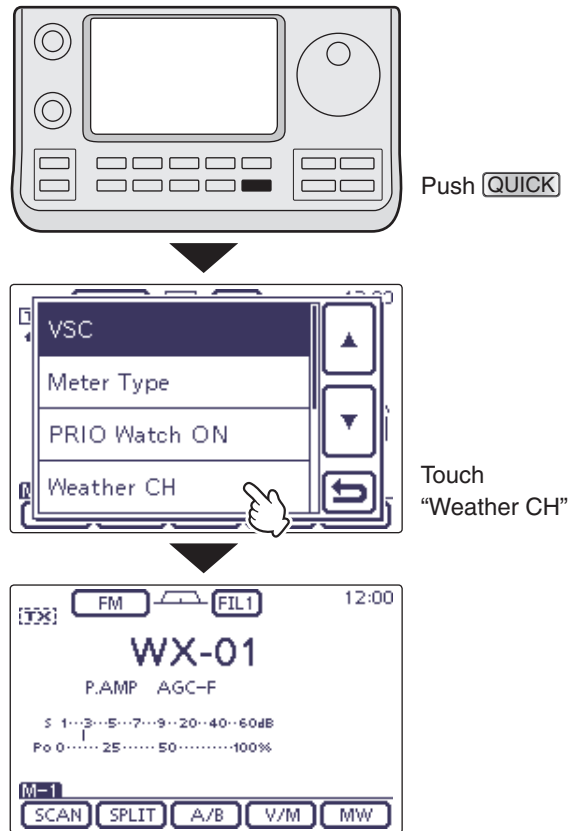
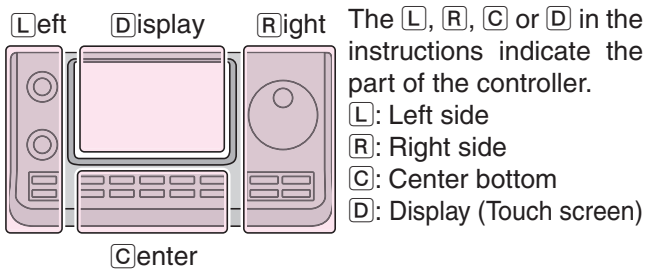

### ◇ Weather alert function

NOAA broadcast stations transmit weather alert tones before important weather announcements. When the weather alert function is turned ON, the selected weather channel is monitored every 5 seconds for the announcement.

When the alert signal is detected, the "ALT" and the WX channel are alternately displayed, and a beep tone sounds until the transceiver is operated.

The previously selected (used) weather channel is checked periodically during standby or while scanning.

- ① Push **QUICK**(C) to open the Quick Menu window.
- ② Touch "Weather Alert."
  - If the specified item is not displayed, touch [▲] or [▼](D) to select the page.
- ③ Touch "ON" to turn ON the function.
  - In this step, touch "OFF" to turn OFF the function.
- ④ Set the desired standby mode.
  - "WX" appears when "ON" is selected in step ③.
  - Select the VFO, a Memory or Call channel.
  - Scan or priority watch operation can also be selected.

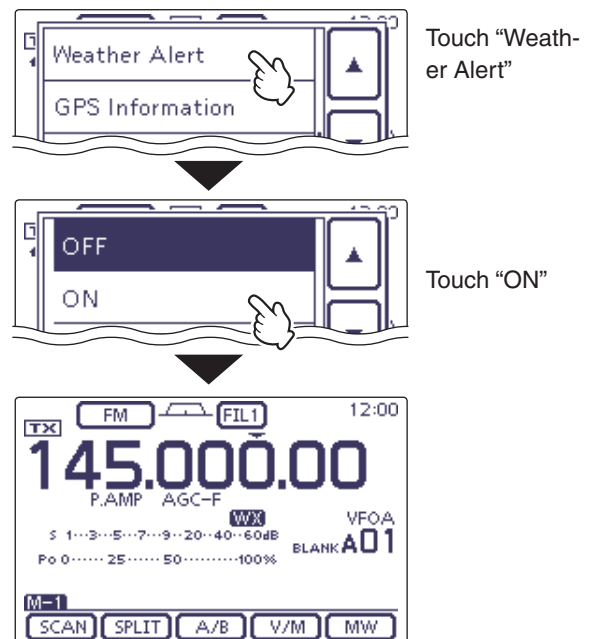

## For reference to USA version

### ◇ About the 5 MHz frequency band operation (USA version only)

Operation on the 5 MHz frequency band is allowed on 5 discrete frequencies and must adhere to the following:

- The USB, USB Data, CW and PSK modes
- Maximum of 100 watts ERP (Effective Radiated Power)
- 2.8 kHz **bandwidth** (maximum)

It is your responsibility to set all controls so that transmission in this frequency band meets the stringent conditions under which amateur operations may use these frequencies.

**NOTE:** We recommend that you store these frequencies, modes and filter settings into memory channels, for easy recall.

To assist you in operating within the rules specified by the FCC, transmission is illegal on any frequencies other than the five shown in the tables at the right.

#### • For the USB mode

The FCC specifies center frequencies on the 5 MHz frequency band. However, the transceiver displays **carrier** frequency. Therefore, tune the transceiver to 1.5 kHz below the specified FCC channel center frequency.

Transceiver Displayed Frequency	FCC Channel Center Frequency
5.33050 MHz	5.33200 MHz
5.34650 MHz	5.34800 MHz
5.35700 MHz	5.35850 MHz
5.37150 MHz	5.37300 MHz
5.40350 MHz	5.40500 MHz

#### • For the CW mode

The transceiver displays the center frequency. Therefore, tune the transceiver to the specified FCC channel frequency when you operate in the CW mode.

Transceiver Displayed Frequency	FCC Channel Center Frequency
5.33200 MHz	5.33200 MHz
5.34800 MHz	5.34800 MHz
5.35850 MHz	5.35850 MHz
5.37300 MHz	5.37300 MHz
5.40500 MHz	5.40500 MHz

<b>Operating SSB .....</b>	<b>4-2</b>
<b>Operating CW.....</b>	<b>4-3</b>
◇ About the CW reverse mode .....	4-4
◇ About keying speed.....	4-4
◇ About CW pitch control.....	4-4
◇ CW sidetone function .....	4-5
◇ CW Auto tune function .....	4-5
<b>Electronic keyer functions.....</b>	<b>4-6</b>
◇ Memory keyer menu construction .....	4-6
◇ Memory keyer send menu .....	4-7
◇ Editing a memory keyer.....	4-8
◇ Contest number Set mode .....	4-9
◇ Keyer Set mode.....	4-10
<b>Operating RTTY (FSK).....</b>	<b>4-12</b>
<b>The functions for RTTY operation.....</b>	<b>4-13</b>
◇ About RTTY reverse mode.....	4-13
◇ Twin Peak Filter .....	4-13
◇ RTTY Set mode.....	4-14
◇ RTTY decoder .....	4-15
◇ RTTY decode Set mode.....	4-16
◇ Transmitting an RTTY memory.....	4-17
◇ Editing an RTTY memory .....	4-18
◇ Turning ON the RTTY decode log .....	4-19
◇ RTTY decode log Set mode .....	4-20
<b>Operating AM/FM.....</b>	<b>4-21</b>
<b>Tone squelch operation .....</b>	<b>4-22</b>
<b>DTCS operation .....</b>	<b>4-23</b>
<b>Tone scan/DTCS code scan operation .....</b>	<b>4-24</b>
<b>Repeater operation.....</b>	<b>4-25</b>
◇ Repeater access tone frequency setting.....	4-26
◇ One-touch repeater function.....	4-27
◇ Transmit frequency monitor check.....	4-28
◇ 1750 Hz tone burst.....	4-28
◇ Turning ON the Auto Repeater function (U.S.A. and Korea versions only).....	4-29
◇ Storing a non standard repeater .....	4-30

## Operating SSB

- ① Select the desired frequency band. (p. 3-6)
- ② On the Mode selection screen, touch “SSB” to select the LSB or USB mode.
  - When operating above 10 MHz, USB is selected first; when operating below 10 MHz, LSB is selected first.
  - After selecting LSB or USB, touch “SSB” again to toggle between USB and LSB modes, if necessary.
  - To select the data mode, after selecting LSB or USB, touch “DATA” to select the data mode, if needed.
- ③ Rotate the Dial to tune a desired signal.
  - The S-meter displays the received signal strength.
  - The tuning step can be changed on the Tuning step selection screen by touching “kHz frequency.” (p. 3-9)
- ④ Rotate [AF] (L) to adjust the audio to a comfortable listening level.
- ⑤ Push [PTT] on the microphone to transmit.
  - The TX/RX indicator lights red.
- ⑥ Speak into the microphone at your normal voice level.
- ⑦ If necessary, adjust the microphone gain or RF power on the Mic gain/RF power adjustment display.

- ① Push [MIC/RF PWR] (C) to open the MIC gain/RF power adjustment display.

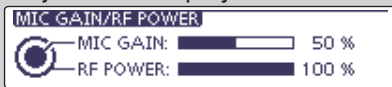

- ② Rotate [M-CH] (L) to adjust the MIC gain, or [BANK] (L) to adjust the RF power.
  - To adjust the MIC gain, touch the TX meter to select the **ALC** meter. And then, adjust it so that the ALC meter reading stays within the ALC zone.
  - /// When the MIC gain is adjusted too high, your transmitted voice may be distorted.
- ③ Push [MENU] (C) to close the display.

- ⑧ Release [PTT] to receive.

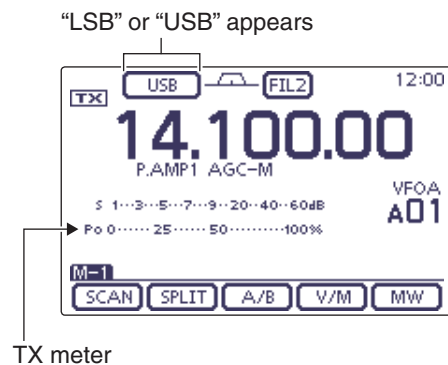
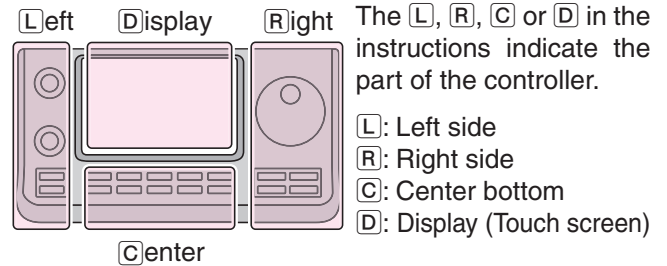

### Convenient Receive functions

- Preamp and attenuator (p. 5-2)
- Twin **PBT** (passband tuning) (p. 5-5)
- **AGC** (auto gain control) (p. 5-3)
- Noise blanker (p. 5-8)
- Noise reduction (p. 5-9)
- **Notch filter** (p. 5-10)
- Receive filter width (HPF/LPF) (Section 17)
- Tone control (p. 17-7,17-23)

### Convenient Transmit functions

- Speech compressor (p. 6-5)
- **VOX** (voice operated transmit) (p. 6-2)
- Transmit quality monitor (p. 6-7, Section 17)
- Transmit filter width (p. 6-6, Section 17)
- Tone control (p. 17-7,17-23)



## Operating CW

- ① Select the desired frequency band. (p. 3-6)
- ② On the Mode selection screen, touch "CW" to select the CW mode.
  - After the CW mode is selected, touch "CW" again to toggle between CW and CW-R modes, if necessary.
- ③ Rotate the Dial to tune a desired signal.
  - The S-meter displays the received signal strength.
  - The tuning step can be changed on the Tuning step selection screen by touching "kHz frequency." (p. 3-9)
- ④ Rotate [AF] (L) to adjust the audio to a comfortable listening level.
- ⑤ Set the Break-in operation to the semi break-in or full break-in mode.
  - "BKIN," "F-BKIN" or "OFF (no indication)" appears.

While the "M-3" menu is selected, touch [BK-IN] (D) once or twice to select the Break-in operation.

- BKIN : Semi break-in
- F-BKIN : Full break-in
- OFF : No break-in (ACC socket connection for TX is necessary, as shown on page 1-17.)  
If a microphone is connected, its PTT can be used instead of the external TX switch.

- ⑥ If the Semi break-in operation is selected at step ⑤, set the Break-in delay.

- ① While the "M-3" menu is selected, touch [BK-IN] (D) for 1 second to open the Break-in delay adjustment window.



- ② Rotate the Dial to adjust the delay time.
  - The adjustable delay time is between 2.0 and 13.0 dots.

- ⑦ Use the electric keyer or paddle to key your CW signals.
  - The TX/RX indicator lights red.
  - The Po meter indicates transmitted CW output power.
- ⑧ If desired, adjust the Key speed or CW pitch.

- ① Push [SPEED/PITCH] (C) to open the Key speed/CW pitch adjustment window.



- ② Rotate [M-CH] (L) to adjust the Key speed, or [BANK] (L) to the CW pitch.
  - The adjustable key speed is between 6 and 48 wpm (words per minute).
  - The adjustable CW pitch is between 300 and 900 Hz.
- ③ Push [MENU] (C) to close the window.

- ⑨ Stop keying to return to receive.

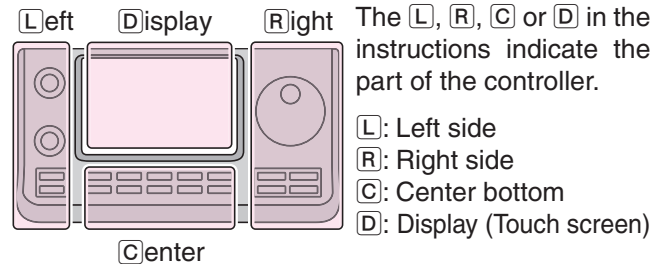

"CW" or "CW-R" appears

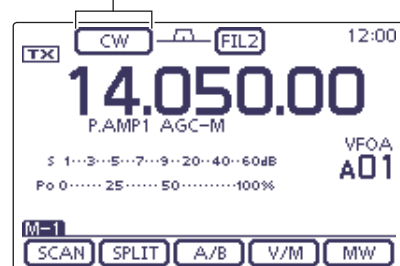

Appears

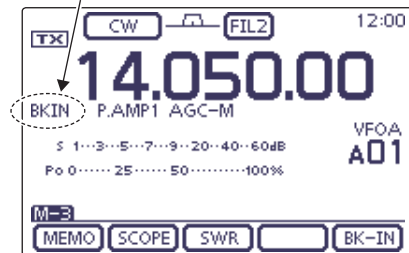

Semi break-in operation is selected

### Convenient Receive functions

- Preamp and attenuator (p. 5-2)
- Twin PBT (passband tuning) (p. 5-5)
- AGC (auto gain control) (p. 5-3)
- Noise blanker (p. 5-8)
- Noise reduction (p. 5-9)
- Manual Notch filter (p. 5-10)
- ¼ function (p. 3-10)
- CW pitch control (p. 4-4)

### Convenient Transmit functions

- Break-in function (p. 6-3)
- Keying speed setting (p. 4-4)
- Memory keyer (p. 4-6)

**Operating CW (Continued)**

◇ **About the CW reverse mode**

The CW reverse mode receives signals with a reverse side CW **carrier** point similar to voice LSB and USB modes.

Use when interfering signals are near a desired signal and you want to reduce the interfering tone.

- ① On the Mode selection screen, touch “CW” to select the CW mode.
- ② After the CW mode is selected, touch “CW” again on the Mode selection screen to toggle between CW and CW-R modes.
  - Check that the interfering tone can be reduced.

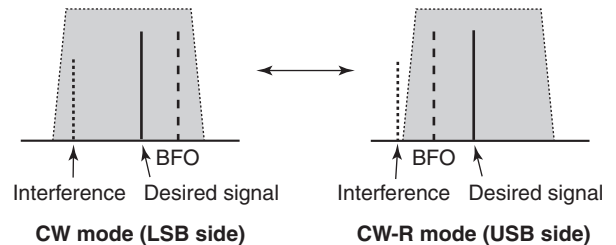

**Carrier point**

The CW carrier point is set to the LSB side by default, the setting can be changed to USB side in the “CW Normal Side” item of the “Function” Set mode. (p. 17-21)

**SET**(C) > Function > **CW Normal Side**

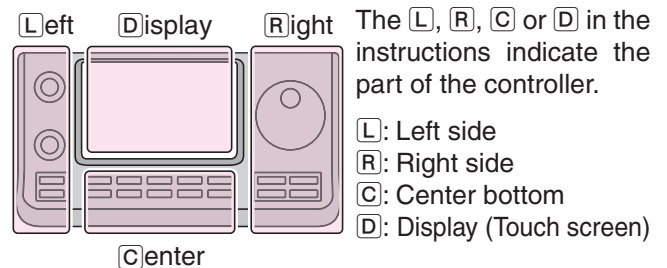

◇ **About keying speed**

The transceiver’s internal electronic keyer speed can be adjusted to between 6 and 48 wpm (words per minute).

- ① Push **SPEED/PITCH**(C) to open the Key speed/CW pitch adjustment display.
- ② Rotate **[M-CH]**(L) clockwise to increase keying speed; counterclockwise to decrease it.
- ③ Push **MENU**(C) to close the display.

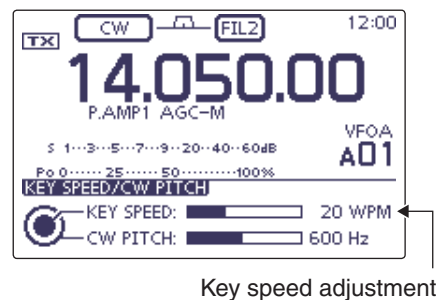

◇ **About CW pitch control**

The received CW audio pitch can be adjusted to suit your preference without changing the operating frequency.

- ① Push **SPEED/PITCH**(C) to open the Key speed/CW pitch adjustment display.
- ② Rotate **[BANK]**(L) to suit your preference.
  - Adjustable from 300 to 900 Hz (in 5 Hz steps).
- ③ Push **MENU**(C) to close the display.

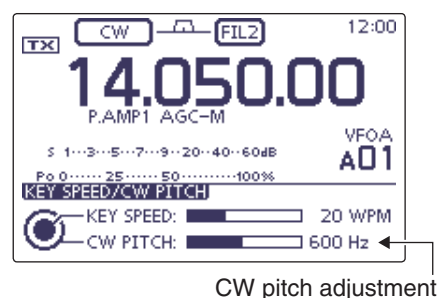

Operating CW (Continued)

◇ CW sidetone function

When the transceiver is in the receive mode (and the Break-in function is OFF— p. 4-3), you can listen to the CW sidetone without actually transmitting. You can also use the CW sidetone to practice CW sending, but be sure to turn OFF the Break-in function.

The CW sidetone level can be adjusted in the “Side Tone Level” item of the Keyer Set mode (p. 4-10).

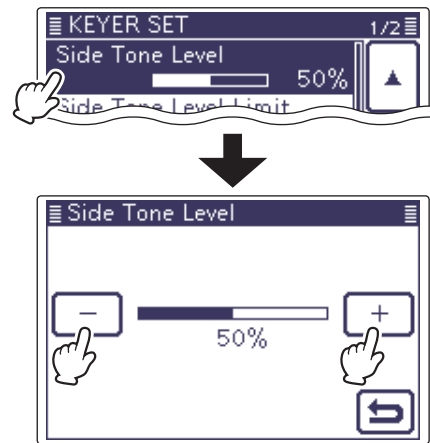

◇ CW Auto tune function

The automatic tuning function automatically tunes the displayed frequency when an off-frequency signal is received. This function is active while in the CW mode is selected.

➔ Push **AUTO TUNE** (R) to automatically adjust for a zero beat with the received signal.

Zero beat means that two signals are exactly the same frequency.

- “AUTO TUNE” blinks when auto tune function is activated.
- If **AUTO TUNE** (R) is pushed when the RIT function is ON, the auto tune function changes the RIT frequency, not the displayed frequency.

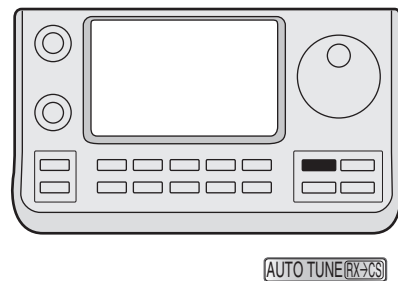

AUTO TUNE icon

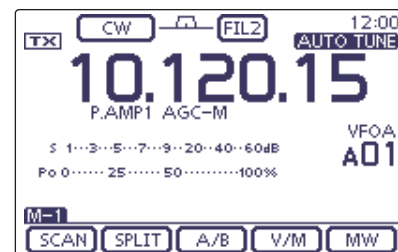

**IMPORTANT!**

When receiving a weak signal, or receiving a signal with interference, the automatic tuning function may tune the receiver to an undesired signal. If the off-frequency signal is too far away, the Auto tune function may not work. In that case, an error beep sounds.

## Electronic keyer functions

You can access a number of convenient built-in electronic keyer functions in the memory keyer menu.

- ① In the CW mode, push **[MENU]**(C) one or more times to select the “M-2” screen (M-2 menu).
- ② Touch **[KEYER]**(D), and then push **[MENU]**(C) to display the “KEYER” screen (Memory Keyer).
- ③ Touch **[SEND]**, **[EDIT]**, **[001]** or **[SET]**(D) to select the desired menu.

See the diagram below.

- Push **[MENU]**(C) to return to the previous display.

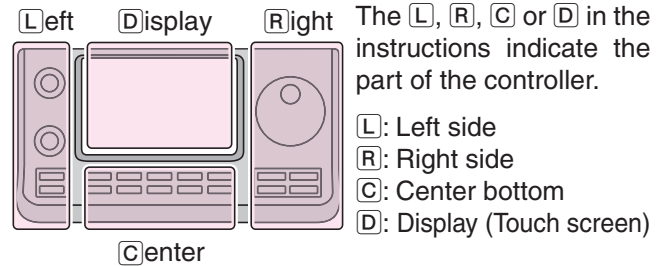

### ◇ Memory keyer menu construction

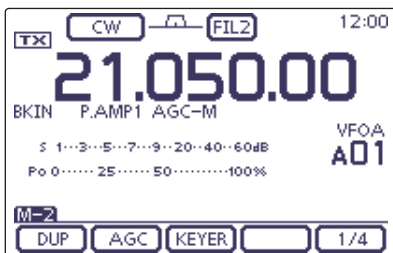

[KEYER]

- Keyer Send screen (p. 4-7)

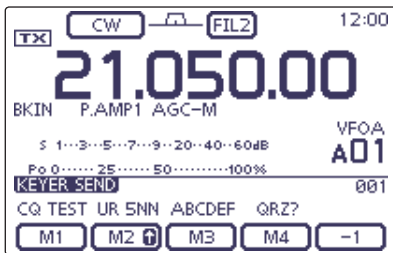

Push **[MENU]**

- Keyer (Root) screen

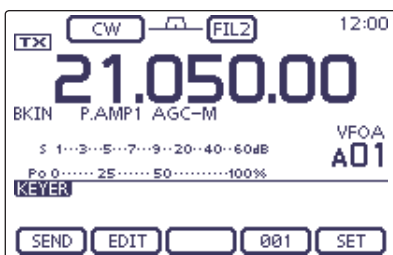

[SEND]

[EDIT]

[001]

[SET]

The screen you want to appear first can be selected in the “KEYER 1st Menu” item of the “Function” Set mode. (p. 17-21)

**[SET]**(C) > Function > **KEYER 1st Menu**

- Keyer Memory (Edit) screen (p. 4-8)

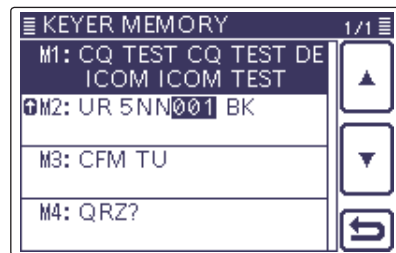

- Keyer 001 (Contest number Set) screen (p. 4-9)

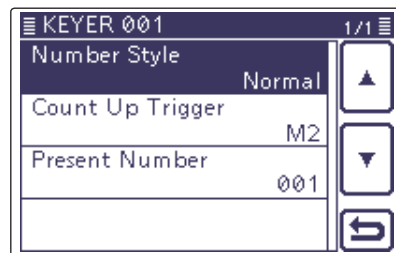

- Keyer Set screen (p. 4-10)

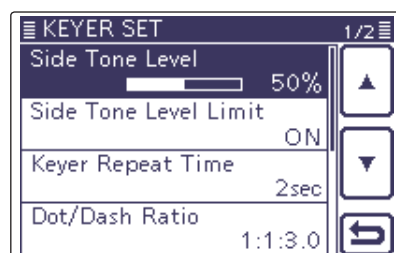

: Returns to the previous display.

Electronic keyer functions (Continued)

◇ Memory keyer send menu

Preset characters can be sent using the Keyer Send screen. Contents of the memory keyer are entered in the Keyer Memory (Edit) screen.

• Transmitting

- ① In the CW mode, turn ON the Break-in function. (p. 6-3)
  - When the Break-in function is OFF and you do step ④, you can listen the memory keyer contents without transmitting.
- ② Push [MENU](C) one or more times to select the “M-2” screen (M-2 menu).
- ③ Touch [KEYER](D) to display the “KEYER SEND” screen.
  - If the “KEYER” (Root) screen is displayed, touch [SEND](D) to display the “KEYER SEND” screen.
- ④ Touch one of the Memory keys, [M1] to [M4](D), to send the memory keyer contents.
  - Touch a Memory key for 1 second to repeatedly send the contents; touch any Memory key to stop the transmission.
  - Set the repeat interval to between 1 and 60 seconds (1 second steps) in the “Keyer Repeat Time” item of the “KEYER SET” screen. (p. 4-11)
  - “M1”–“M4” are highlighted while transmitting.
  - The contest number counter advances each time the contents are sent.
  - Push [-1](D) to reduce the contest number advances by one before sending the memory keyer contents to a station a second time.
- ⑤ Push [MENU](C) to return to the “KEYER” (Root) screen.

▨ For your information

When an external keypad is connected to pin 3 and pin 7 of the [MIC] connector, the contents of M1 to M4 can be transmitted without selecting the “KEYER SEND” screen.  
See page 19-11 for details.

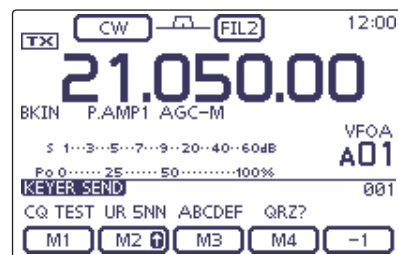
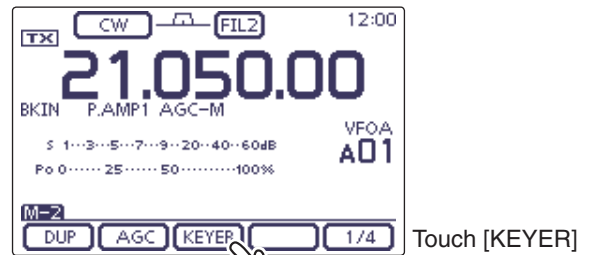

• M1 sending display



• M2 sending display

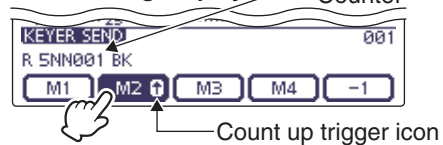

• M3 sending display

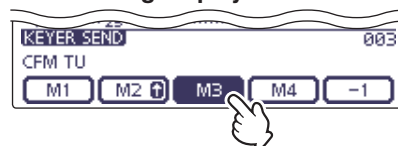

• M4 sending display

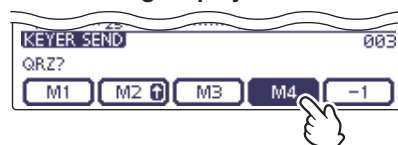

• While transmitting repeatedly

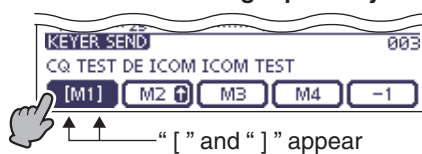

**Electronic keyer functions (Continued)**

**◇ Editing a memory keyer**

The contents of the memory keyer memories can be set on the Keyer Memory (Edit) screen. The memory keyer can memorize and retransmit 4 CW key codes for often-used CW sentences, contest numbers or a count up trigger. The total capacity of the memory keyer is 70 characters per memory channel.

**• Programming contents**

- ① In the CW mode, push **MENU**(C) one or more times to select the “M-2” screen (M-2 menu).
- ② Touch **[KEYER]**(D) to display the “KEYER SEND” screen.
  - If the “KEYER” (Root) screen is displayed, skip step ③.
- ③ Push **MENU**(C) to display the “KEYER” screen.
- ④ Touch **[EDIT]**(D) to display the “KEYER MEMORY” (Edit) screen.
  - The memory contents are displayed.
- ⑤ Touch for 1 second on a desired memory channel to be edited, and then touch “Edit.”
  - The memory programming screen appears.
- ⑥ Touch the desired block one or more times to select the desired character, number or symbol.

**Selectable characters, numbers and symbols**  
 A to Z, 0 to 9, / ? ^ . , @ \*

- Touch “AB↔12” to toggle between the Alphabet input and Number input mode.
  - Touch **[CLR]**(D) to delete the selected character, symbol or number.
  - Touch **[SYMB]**(D) to open the Symbol character selection window.
  - Touch “\_” to input a space.
- ⑦ Touch **[←]**(D) or **[→]**(D) to move the cursor backwards or forwards.
  - ⑧ Repeat steps ⑥ and ⑦ to program up to 70 characters of memory contents, and then push **[ENT]**(D).
  - ⑨ Touch **[↵]**(D) or push **MENU**(C) to return to the “KEYER” (Root) screen.

**NOTE:**

“^” is used to transmit a string of characters with no inter-character space. Put a “^” before a text string such as ^AR, and the string “AR” is sent with no space.  
 “\*” is used to insert the CW contest number. The number automatically advances by 1. This function is available for only one memory keyer channel at a time. “\*” is used in memory keyer channel M2 by default.

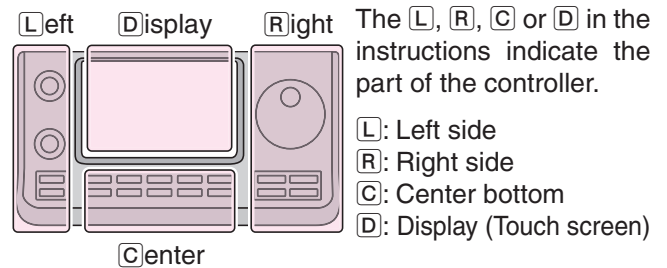

**• Memory keyer programming mode**

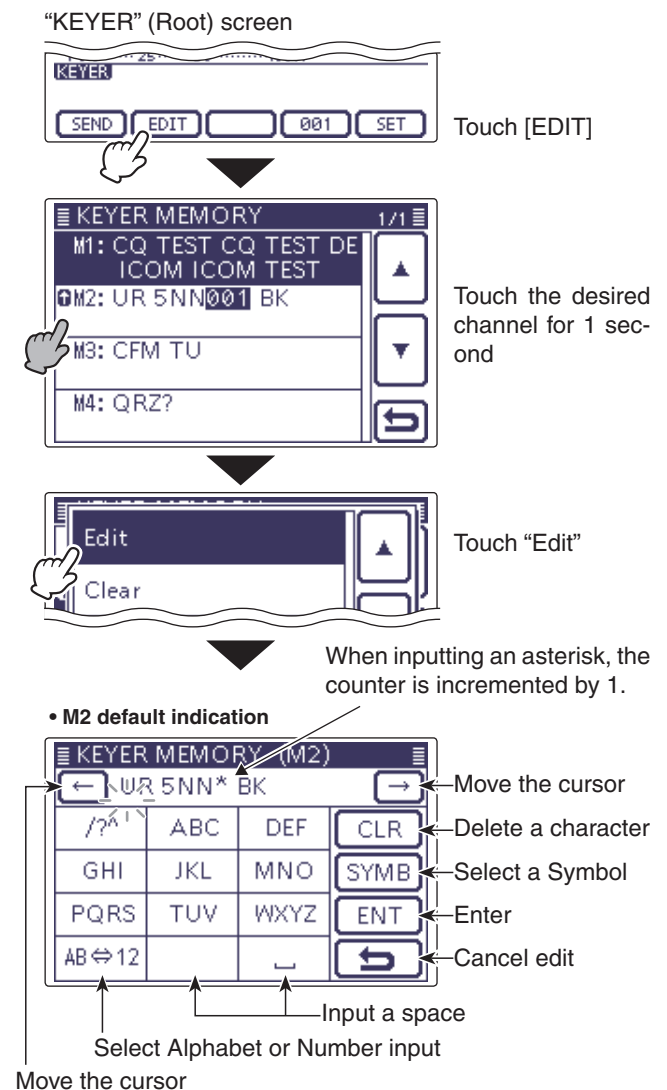

**• Preprogrammed memory keyer contents**

Memory keyer channel	Contents
M1	CQ TEST CQ TEST DE JA1 JA1 TEST
M2	UR 5NN* BK
M3	CFM TU
M4	QRZ?

Electronic keyer functions (Continued)

**◇ Contest number Set mode**

This mode is used to set the contest number, count up trigger and Present number.

**• Setting contents**

- ① In the CW mode, push **MENU**(**C**) one or more times to select the “M-2” screen (M-2 menu).
- ② Push **[KEYER]**(**D**) to display the “KEYER SEND” screen.
  - If the “KEYER” (Root) screen is displayed, skip step ③.
- ③ Push **MENU**(**C**) to display the “KEYER” screen.
- ④ Push **[001]**(**D**) to enter the “KEYER 001” (Contest Number Set) screen.
- ⑤ Touch the desired item to select.
- ⑥ Touch the desired option or rotate the Dial to change the setting.
  - If desired, touch the item for 1 second to open the Default set window, then select “Default” to reset to the default setting.
- ⑦ Push **MENU**(**C**) to return to the “KEYER” (Root) screen.

The **L**, **R**, **C** or **D** in the instructions indicate the part of the controller.  
**L**: Left side, **R**: Right side, **C**: Center bottom  
**D**: Display (Touch screen)

**• Contest number Set mode**

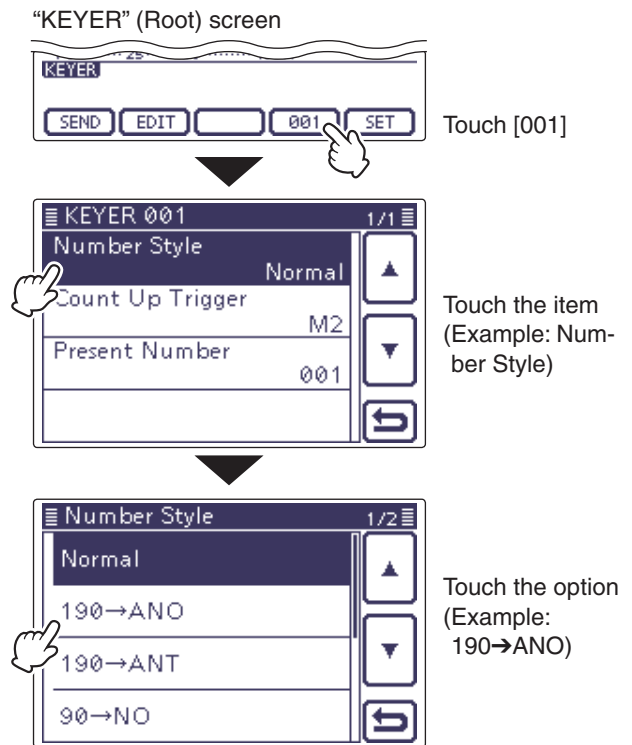

**Number Style (Default: Normal)**

This item sets the numbering system used for contest numbers— normal or short morse numbers.

Short morse numbers are also referred to as “cut” numbers.

- Normal: Does not use short morse numbers
- 190→ANO: Sets 1 as A, 9 as N and 0 as O.
- 190→ANT: Sets 1 as A, 9 as N and 0 as T.
- 90→NO: Sets 9 as N and 0 as O.
- 90→NT: Sets 9 as N and 0 as T.

**Count Up Trigger (Default: M2)**

Set the count-up trigger to one of four memory slots for the contest number exchange. The count-up trigger allows the contest number to automatically advance after each complete number exchange is sent.

- M1, M2, M3 or M4 can be set.

**Present Number (Default: 001)**

This item shows the current number for the count-up trigger channel set above.

- Touch **[+]** or **[-]**(**D**) or rotate the Dial to change the number.
- Hold down the item for 1 second to display the default set window, then touch “Default” to set the counter to “001.”

**• To the default setting**

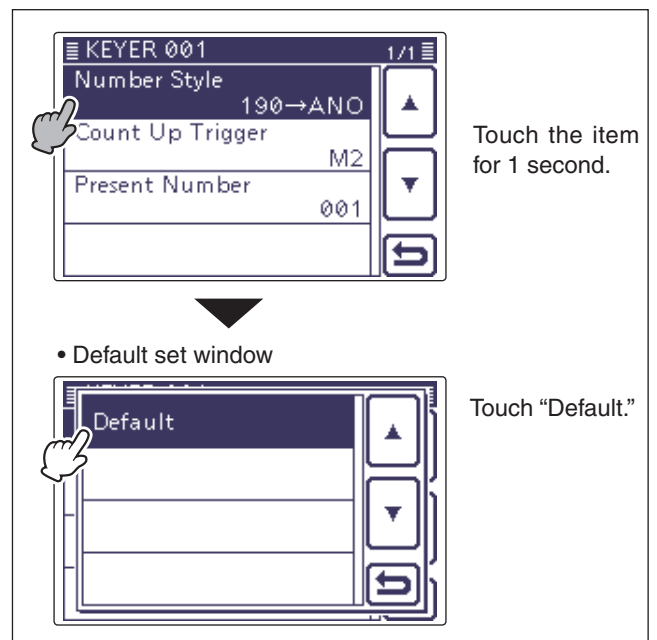



**Electronic keyer functions (Continued)**

**◆ Keyer Set mode**

This Set mode is used to set the CW sidetone, memory keyer repeat time, dash weight, paddle specifications, keyer type, and so on.

**• Setting contents**

- ① In the CW mode, push **MENU**(C) one or more times to select the “M-2” screen (M-2 menu).
- ② Push **[KEYER]**(D) to display the “KEYER SEND” screen.
  - If the “KEYER” (Root) screen is displayed, skip step ③.
- ③ Push **MENU**(C) to display the “KEYER” screen.
- ④ Touch **[SET]**(D) to enter the “KEYER SET” screen.
- ⑤ Touch the desired item to select.
  - See the next page for details of the set items and options.
- ⑥ Touch the desired option or rotate the Dial to change the value.
  - If desired, touch the item for 1 second to open the Default set window, then select the “Default” to reset to the default setting.
- ⑦ Touch **[↶]**(D) or push **MENU**(C) to return to the “KEYER” (Root) screen.

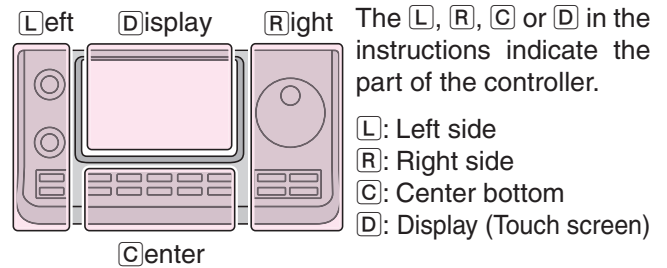

**• Keyer Set mode**

“KEYER” screen (Memory Keyer)

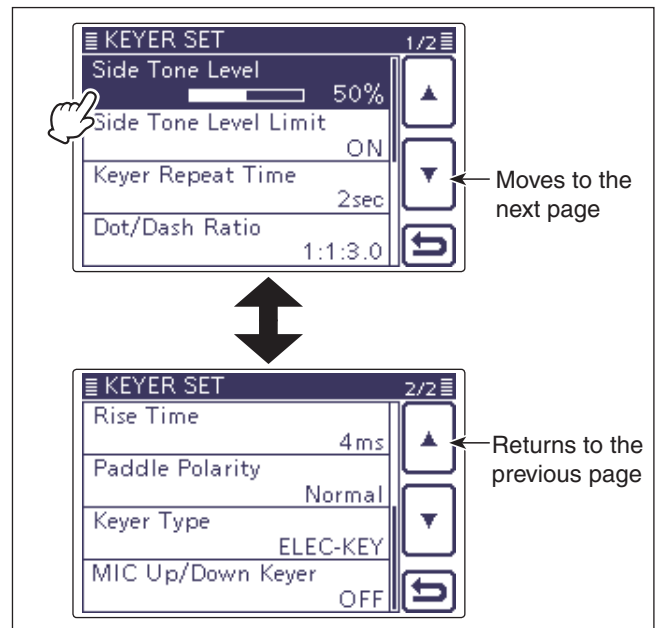
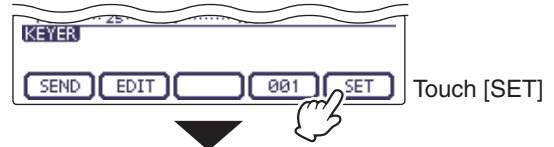

(Example: Touch the “Side Tone Level.”)

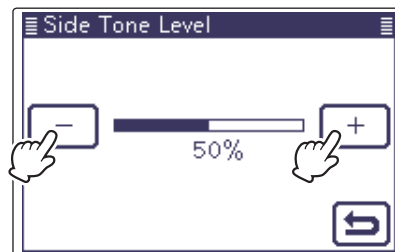



**Electronic keyer functions (Continued)**

◇ Keyer set mode (Continued)

**Side Tone Level (Default: 50%)**

Select the CW sidetone output level.

- 0 to 100% can be selected.

**Side Tone Level Limit (Default: ON)**

Set the CW sidetone level limit. When the [AF] (L) control is rotated above a specified level, the CW sidetone does not increase.

- OFF: CW sidetone level is not limited.
- ON: CW sidetone level is limited.

**Keyer Repeat Time (Default: 2sec)**

When sending CW using the repeat timer, set the time between transmissions.

- 1 to 60 seconds in 1 second steps can be selected.

**Dot/Dash Ratio (Default: 1:1:3.0)**

Set the dot/dash ratio.

- 1:1:2.8 to 1:1:4.5 (in 0.1 steps) can be selected.

**Keying weight example:** Morse code “K”

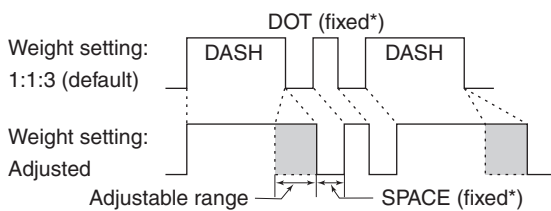

\*SPACE and DOT length can be adjusted on the Key Speed/CW pitch adjustment display.

**Rise Time (Default: 4ms)**

Set the rise time of the transmitted CW envelope.

- 2, 4, 6 or 8 milliseconds can be selected.

**About rise time**

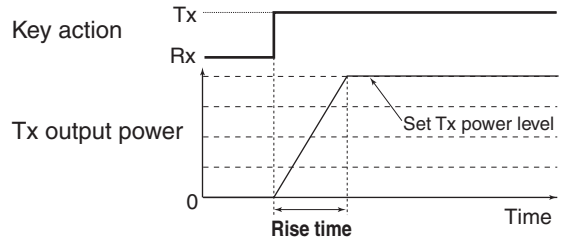

Key clicks on nearby frequencies can be generated if the rise time of a CW waveform is too short.

**Paddle Polarity (Default: NORMAL)**

Set the paddle polarity.

- Normal or reverse polarity can be selected.

**Keyer Type (Default: ELEC-KEY)**

Select the keyer type for [ELEC-KEY] connector on the controller.

- Straight key, BUG-KEY or ELEC-KEY can be selected.

Regardless of this setting, the [KEY] connector of the Main unit is for only a straight key.

**MIC Up/Down Keyer (Default: OFF)**

Set the microphone [UP]/[DN] switches to be used as a key. (The microphone [UP]/[DN] switches do not work as a “squeeze key.”)

- ON: The [UP]/[DN] switches can be used as a key for CW.
- OFF: The [UP]/[DN] switches cannot be used as a key for CW.

When “ON” is selected, the frequency and memory channels cannot be changed using the [UP]/[DN] switches. The optional HM-151 microphone cannot be used as a MIC Up/Down Keyer.

## Operating RTTY (FSK)

When using your RTTY terminal or TNC, consult the manual that comes with the equipment.

- ① Select the desired frequency band. (p. 3-6)
- ② On the Mode selection screen, touch “RTTY” to select the RTTY mode.
  - After the RTTY mode is selected, touch “RTTY” again to toggle between the normal and reverse modes, if needed.
- ③ Enter the RTTY decoder screen.

- ① Push **MENU**(C) one or more times to select the “M-2” screen (M-2 menu).
- ② Touch **[DEC]**(D) to display the RTTY decoder screen.
  - Touch **[WIDE]**(D) to toggle the decode screen size between normal and wide.

- ④ Rotate the Dial to tune a desired signal.
  - The S-meter displays the received signal strength.
  - If the received signal cannot be demodulated, try to select the RTTY reverse mode in step ②.
  - The tuning step can be changed on the Tuning step selection screen by touching “kHz frequency.” (p. 3-9)
- ⑤ Switch ON the external TX switch to set the transceiver to the transmit mode, or transmit a SEND signal from your TNC.
  - The TX/RX indicator lights red.
  - The Po meter displays the transmitted RTTY signal strength.
- ⑥ Use your connected PC or TNC (TU) to transmit RTTY (FSK) signals.
- ⑦ Switch OFF the external TX switch to receive.

### Convenient Receive functions

- Preamp and attenuator (p. 5-2)
- Twin **PBT** (passband tuning) (p. 5-5)
- **AGC** (auto gain control) (p. 5-3)
- Noise blanker (p. 5-8)
- Noise reduction (p. 5-9)
- **Notch filter** (p. 5-10)
- ¼ function (p. 3-10)
- Twin Peak Filter (p. 4-13)

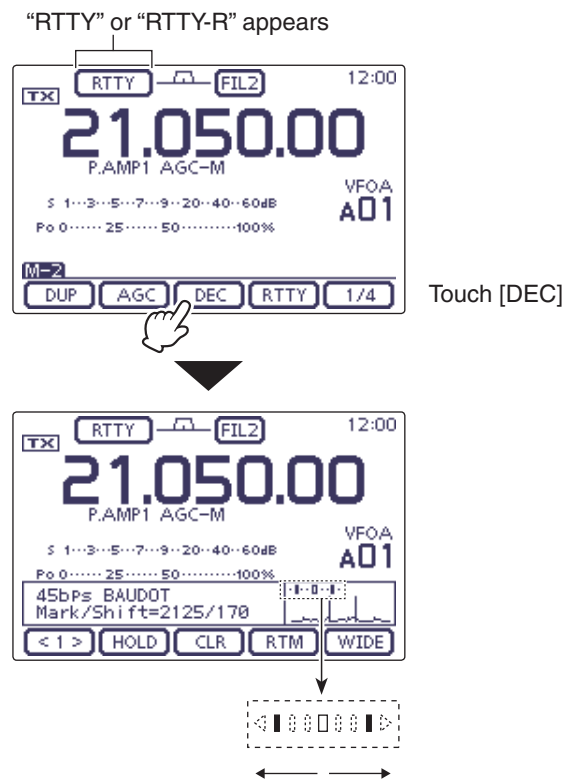
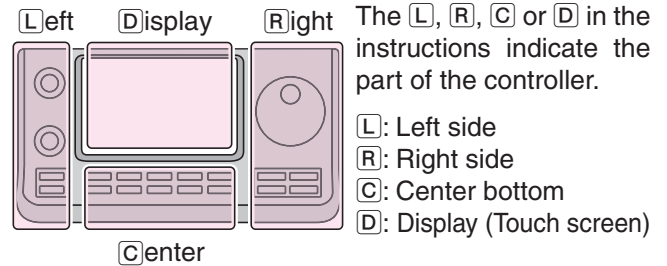

## The functions for RTTY operation

### ◇ About RTTY reverse mode

Received characters are occasionally garbled when the Mark and Space signals are reversed. This reversal can be caused by incorrect TNC connections, setting or commands.

To correctly receive reversed RTTY signals, select the RTTY reverse mode.

- ① On the Mode selection screen, touch “RTTY” to select the RTTY mode.
- ② After the RTTY mode is selected, touch “RTTY” again on the Mode selection screen, toggles between the normal and reverse modes.
  - “RTTY-R” appears when the RTTY reverse mode is selected.

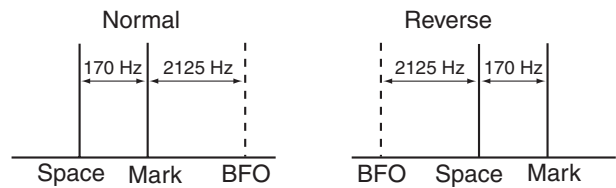
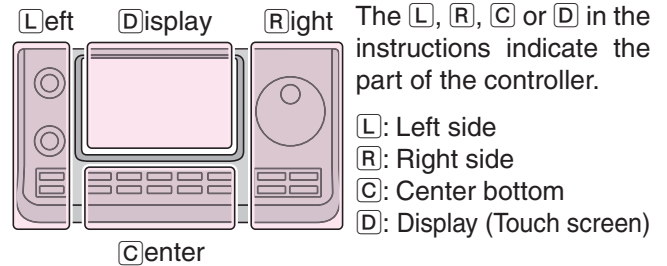

### ◇ Twin Peak Filter

The Twin Peak Filter changes the receive frequency response by boosting 2125 and 2295 Hz for better copying of RTTY signals.

- ① In the RTTY mode, push **MENU**(C) one or more times to select the “M-2” screen (Menu M-2).
- ② Touch [RTTY](D) to display the “RTTY SET” screen.
- ③ Touch the “Twin Peak Filter” item to select.
- ④ Touch “ON” to turn ON the Twin Peak Filter.
- ⑤ Touch [↶](D) or push **MENU**(C) to return to the “M-2” screen (Menu M-2).

**NOTE:** When the Twin Peak Filter is in use, the received audio output may increase. This is normal; not a malfunction.

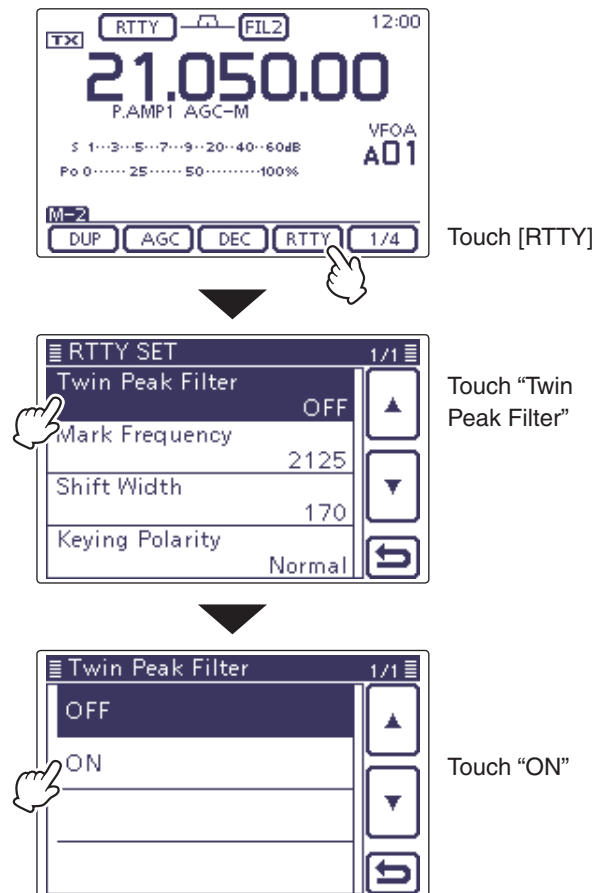

The functions for RTTY operation (Continued)

◇ RTTY Set mode

The RTTY Set mode is used to set the Twin peak filter function, mark and shift frequencies and the keying polarity.

• Setting contents

- ① In the RTTY mode, push **MENU**(C) one or more times to select the “M-2” screen (Menu M-2).
- ② Touch **[RTTY]**(D) to display the “RTTY SET” screen.
- ③ Touch the desired item to select.
  - See below for details of the set items and options.
- ④ Touch the desired option or rotate the Dial to change the setting.
  - If desired, touch the item for 1 second to open the Default set window, then select the “Default” to reset to the default setting.
- ⑤ Touch **[↶]**(D) or push **MENU**(C) to return to the “M-2” screen (Menu M-2).

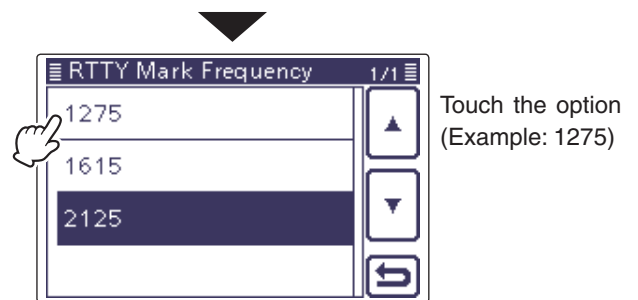
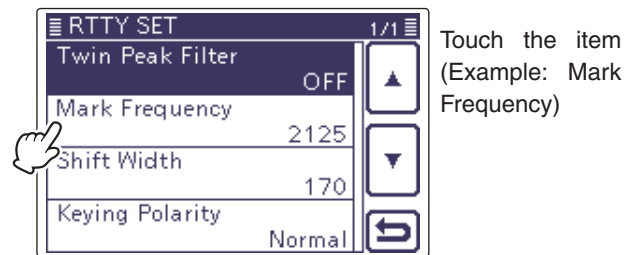
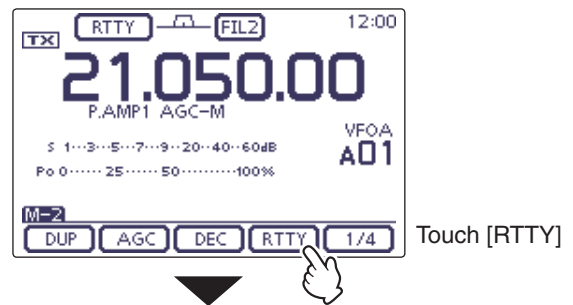
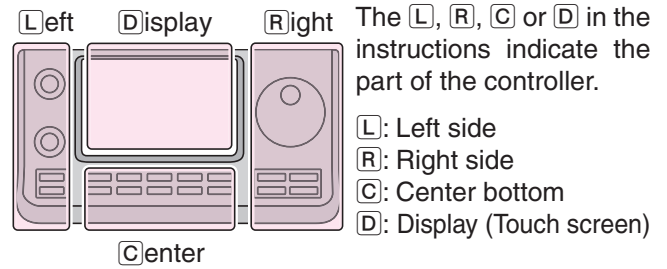

**Twin Peak Filter** (Default: OFF)

Turn the Twin Peak Filter ON or OFF.

**Mark Frequency** (Default: 2125)

Select the RTTY mark frequency.

- 1275, 1615 and 2125 Hz are selectable.

**Shift Width** (Default: 170)

Select the RTTY frequency shift.

- 170, 200 and 425 Hz are selectable.

**Keying Polarity** (Default: NORMAL)

Select normal or reverse keying polarity.

- NORMAL: Key open/close = Mark/Space
- REVERSE: Key open/close = Space/Mark

The functions for RTTY operation (Continued)

◆ RTTY decoder

The transceiver has an RTTY decoder for Baudot (mark frequency: 2125 Hz, shift frequency: 170 Hz, 45 bps).

An external terminal unit (TU) or terminal node connector (TNC) is not necessary for receiving a Baudot signal.

- ① In the RTTY mode, push **[MENU]**(C) one or more times to select the “M-2” screen (Menu M-2).
- ② Touch **[DEC]**(D) to display the RTTY decoder screen.
  - Touch **[WIDE]**(D) to toggle the decode screen size between normal and wide.
- ③ Touch **[HOLD]**(D) to turn ON the Hold function to hold the current screen.
  - “H” appears when this function is turned ON.
  - Touch **[HOLD]**(D) again to turn OFF the Hold function.
- ④ Touch **[CLR]**(D) for 1 second to clear the displayed characters.
- ⑤ Push **[MENU]**(C) to return to the “M-2” screen (Menu M-2).

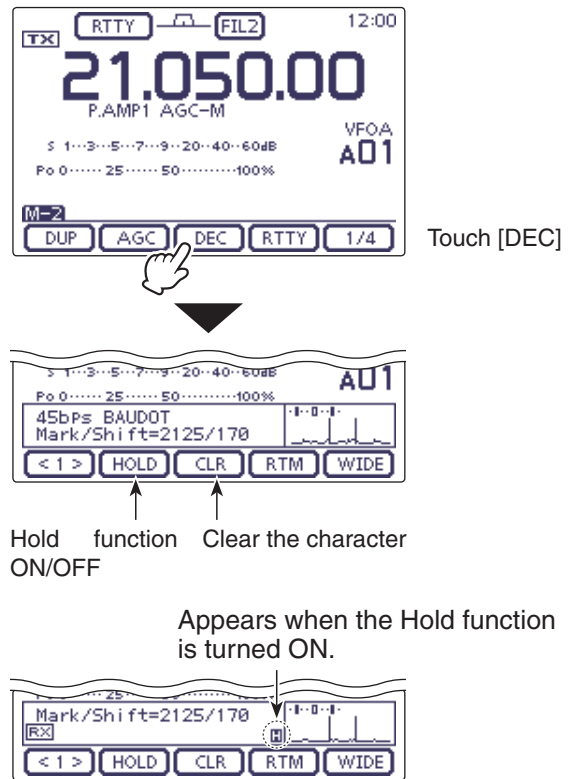

• Setting the decoder threshold level

If some characters are displayed when no signal is received, adjust the RTTY decoder threshold level.

- ① In the RTTY mode, push **[MENU]**(C) one or more times to select the “M-2” screen (Menu M-2).
- ② Touch **[DEC]**(D) to display the RTTY decoder screen.
  - Touch **[WIDE]**(D) to toggle the decode screen size between normal and wide.
- ③ Touch **[<1>]**(D) to display the RTTY decoder (2) screen.
  - Touch **[<1>]** or **[<2>]**(D) to toggle between the RTTY decoder and the RTTY decode (2) screens.
- ④ Touch **[ADJ]**(D) to select the threshold level adjustment mode.
- ⑤ Rotate the Dial to adjust the RTTY decoder threshold level.
  - Touch **[DEF]**(D) for 1 second to reset to the default setting, if desired.
- ⑥ Push **[MENU]**(C) to exit the adjustment mode.

The **[L]**, **[R]**, **[C]** or **[D]** in the instructions indicate the part of the controller.  
**[L]**: Left side, **[R]**: Right side, **[C]**: Center bottom  
**[D]**: Display (Touch screen)

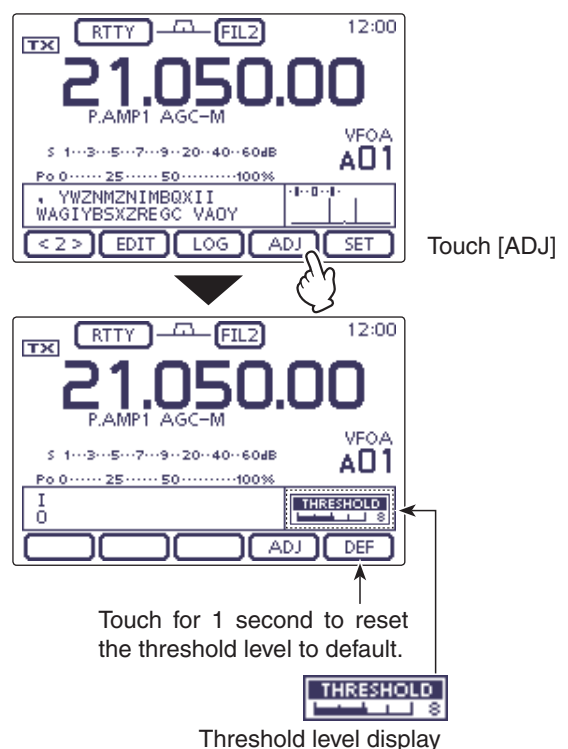

▨ The number of the decoder display lines, the UnShift On Space (USOS) function and new line code can be set in the RTTY Set mode. (p. 4-16)

The functions for RTTY operation (Continued)

◇ RTTY decode Set mode

The RTTY decode Set mode is used to set the decode USOS function, RTTY decoder new line code and the TX USOS function.

• Setting contents

- ① In the RTTY mode, push **[MENU]**(C) one or more times to select the “M-2” screen (Menu M-2).
- ② Touch **[DEC]**(D) to display the RTTY decoder screen.
  - Touch **[WIDE]**(D) to toggle the decode screen size between normal and wide.
- ③ Touch **[<1>]**(D) to display the RTTY decoder (2) screen.
  - Touch **[<1>]** or **[<2>]**(D) to toggle between the RTTY decoder and the RTTY decode (2) screens.
- ④ Touch **[SET]**(D) to enter the “RTTY DECODE SET” screen.
- ⑤ Touch the desired item to select.
  - See below for details of the set items and options.
- ⑥ Touch the desired option or rotate the Dial to change the setting.
  - If desired, touch the item for 1 second to open the Default set window, then select the “Default” to reset to the default setting.
- ⑦ Touch **[↵]**(D) or push **[MENU]**(C) to return to the “KEYER” (Root) screen.
- ⑧ Push **[MENU]**(C) to return to the “M-2” screen (Menu 2).

The **[L]**, **[R]**, **[C]** or **[D]** in the instructions indicate the part of the controller.

- [L]**: Left side, **[R]**: Right side, **[C]**: Center bottom
- [D]**: Display (Touch screen)

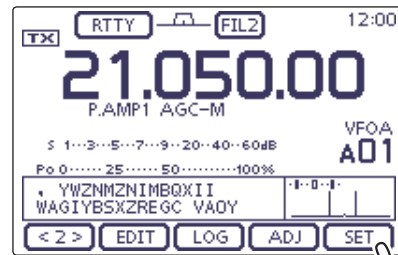

Touch **[SET]**

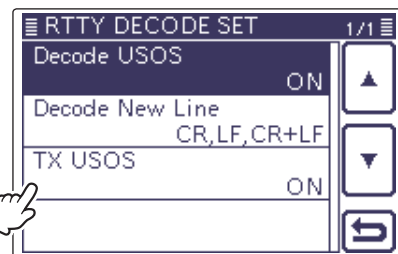

Touch the item (Example: TX USOS)

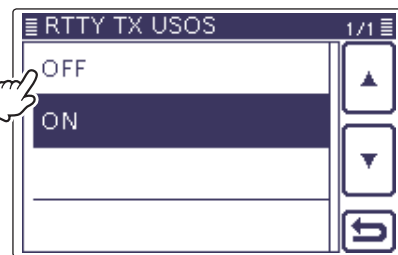

Touch the option (Example: OFF)

**Decode USOS** (Default: ON)

Turn the USOS (UnShift On Space) function ON or OFF. This function decodes a letter code after receiving a “space.”

- OFF: Decodes as a character code
- ON: Decodes as a letter code

**TX USOS** (Default: ON)

Explicitly inserts the FIGS character, even though it is not required by the receiving station.

- OFF: Inserts FIGS
- ON: Does not insert FIGS

**Decode New Line** (Default: CR,LF,CR+LF)

Select the internal RTTY decoder new line code. CR: Carriage Return, LF: Line Feed

- CR,LF,CR+LF: Makes a new line with any code.
- CR+LF: Makes a new line with only the CR+LF code.

The functions for RTTY operation (Continued)

◆ **Transmitting an RTTY memory**

Previously entered characters can be sent using the RTTY memory. Contents of the memory are entered in the RTTY Memory (Edit) screen.

- ① In the RTTY mode, push **[MENU]**(C) one or more times to select the "M-2" screen (Menu M-2).
- ② Touch **[DEC]**(D) to display the RTTY decoder screen.
  - Touch **[WIDE]**(D) to toggle the decode screen size between normal and wide.
- ③ Touch **[RTM]**(D) to display the RTTY memory screen.
- ④ Touch **[▶]**(D) to select the memory group to transmit.
  - Touch **[▶]**(D) to toggle the memory group between RT1-RT4 and RT5-RT8.
- ⑤ Touch one of the memory keys, **[RT1]** to **[RT4]**, or **[RT5]** to **[RT8]**(D).
  - The TX/RX indicator lights red.
  - The TX contents are displayed beside the "TX" icon.
- ⑥ Push **[MENU]**(C) to return to the "M-2" screen (Menu M-2).

/// **For your information**

When an external keypad is connected to [MIC] connector on the Controller, one of RT1 to RT4 RTTY memory contents can be transmitted while the RTTY decode screen is selected in the RTTY mode. (pp. 4-15, 19-9)

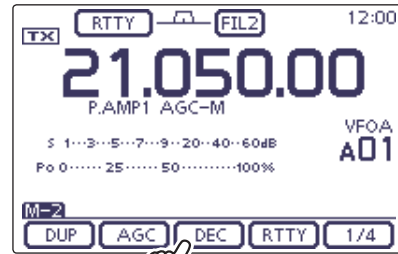

Touch [DEC]

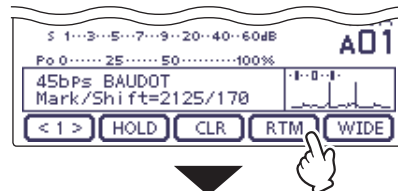

Touch [RTM]

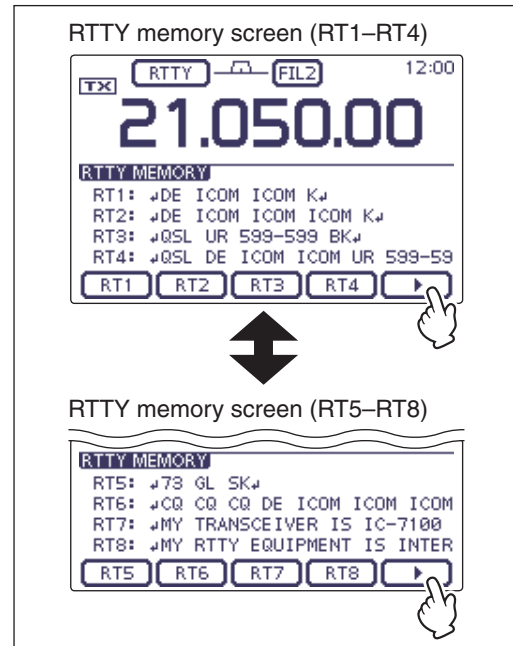

RTTY memory screen (RT1-RT4)

RTTY memory screen (RT5-RT8)

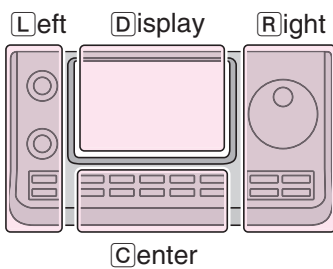

The L, R, C or D in the instructions indicate the part of the controller.

- L: Left side
- R: Right side
- C: Center bottom
- D: Display (Touch screen)

• **Transmits RT6**

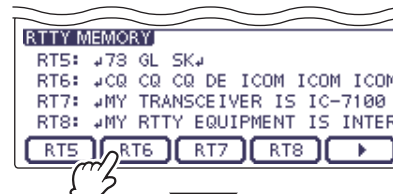

Touch [RT6]



The TX contents are displayed "TX" blinks



The functions for RTTY operation (Continued)

◆ Editing an RTTY memory

The contents of the RTTY memories can be set on the RTTY Memory (Edit) screen. The RTTY memory can memorize and retransmit 8 RTTY message for often-used RTTY information. The total capacity of the RTTY memory is 70 characters per memory channel.

• Programming contents

- ① In the RTTY mode, push **MENU**(C) one or more times to select the “M-2” screen (M-2 menu).
- ② Touch **[DEC]**(D) to display the RTTY decoder screen.
  - Touch **[WIDE]**(D) to toggle the decode screen size between normal and wide.
- ③ Touch **[<1>]**(D) to display the RTTY decoder (2) screen.
  - Touch **[<1>]** or **[<2>]**(D) to toggle between the RTTY decoder and the RTTY decode (2) screens.
- ④ Touch **[EDIT]**(D) to display the “RTTY MEMORY” (Edit) screen.
  - The memory contents are displayed.
- ⑤ Touch for 1 second on a desired memory channel to be edited, and then touch “Edit.”
  - Touch **[▲]** or **[▼]**(D) to select the displayed page.
  - The memory programming screen appears.
- ⑥ Touch the desired block one or more times to select the desired character or symbol.

Selectable characters and symbols
A to Z, 0 to 9, ! \$ & ? ' ' - / . , ; ( ) ↵ (space)

- Touch “AB↔12” to toggle between the Alphabet input and Number input mode.
  - Touch **[CLR]**(D) to delete the selected character, symbol or number.
  - Touch **[SYMB]**(D) to open the Symbol character selection window.
  - Touch “\_” to input a space.
- ⑦ Touch **[←]**(D) or **[→]**(D) to move the cursor backwards or forwards.
  - ⑧ Repeat steps ⑥ and ⑦ to program up to 70 characters of memory contents, and then push **[ENT]**(D).
  - ⑨ Touch **[↵]**(D) or push **MENU**(C) to return to the RTTY Decode (2) screen.

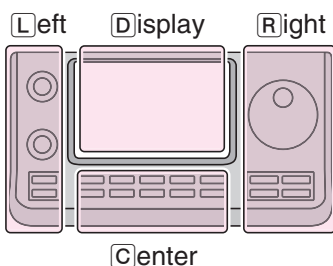

The **L**, **R**, **C** or **D** in the instructions indicate the part of the controller.

- L**: Left side
- R**: Right side
- C**: Center bottom
- D**: Display (Touch screen)

• RTTY memory programming mode

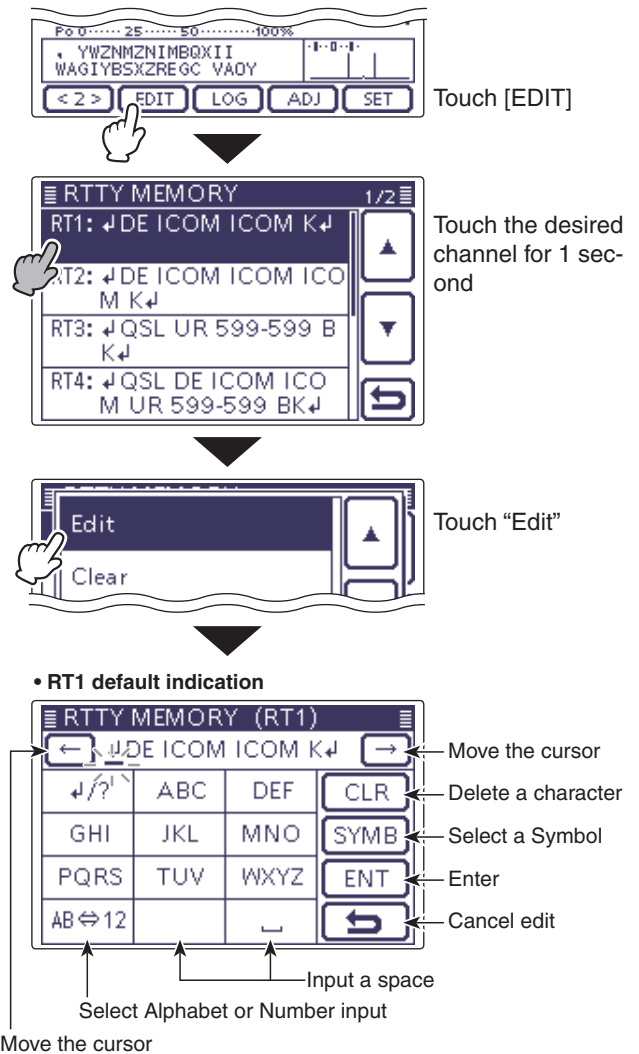

• Preprogrammed contents

CH	Contents
RT1	↵DE ICOM ICOM K↵
RT2	↵DE ICOM ICOM ICOM K↵
RT3	↵QSL UR 599-599 BK↵
RT4	↵QSL DE ICOM ICOM UR 599-599 BK↵
RT5	↵73 GL SK↵
RT6	↵CQ CQ CQ DE ICOM ICOM ICOM K↵
RT7	↵MY TRANSCEIVER IS IC-7100 & ANTENNA IS A 3-ELEMENT TRIBAND YAGI.↵
RT8	↵MY RTTY EQUIPMENT IS INTERNAL FSK UNIT & DEMODULATOR OF THE IC-7100.↵



The functions for RTTY operation (Continued)

◆ Turning ON the RTTY decode log

Turn ON the RTTY decode log to store your RTTY operating record, both TX and RX, into an SD card. Be sure to insert the SD card, otherwise this function does not work properly. The SD card is not supplied by Icom.

- ① In the RTTY mode, push **[MENU]**(C) one or more times to select the “M-2” screen (M-2 menu).
- ② Touch **[DEC]**(D) to display the RTTY decoder screen.
  - Touch **[WIDE]**(D) to toggle the decode screen size between normal and wide.
- ③ Touch **[<1>]**(D) to display the RTTY decoder (2) screen.
  - Touch **[<1>]** or **[<2>]**(D) to toggle between the RTTY decoder and the RTTY decode (2) screens.
- ④ Touch **[LOG]**(D) to display the “RTTY DECODE LOG” screen.
- ⑤ Touch “Decode Log,” and then select the RTTY decode log function ON or OFF.
  - If desired, touch the item for 1 second to open the Default set window, then select “Default” to reset to the default setting.
  - When “ON” is selected, the RTTY decode log starts.
- ⑥ Touch **[↵]**(D) or push **[MENU]**(C) to return to the RTTY Decoder screen.

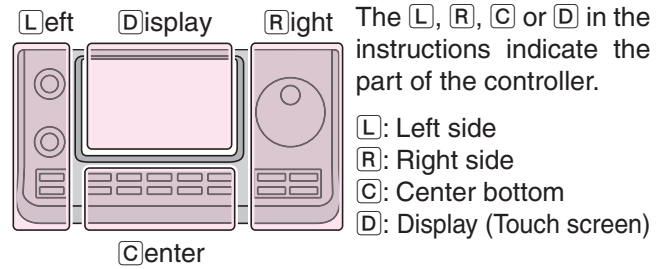

• RTTY decode log

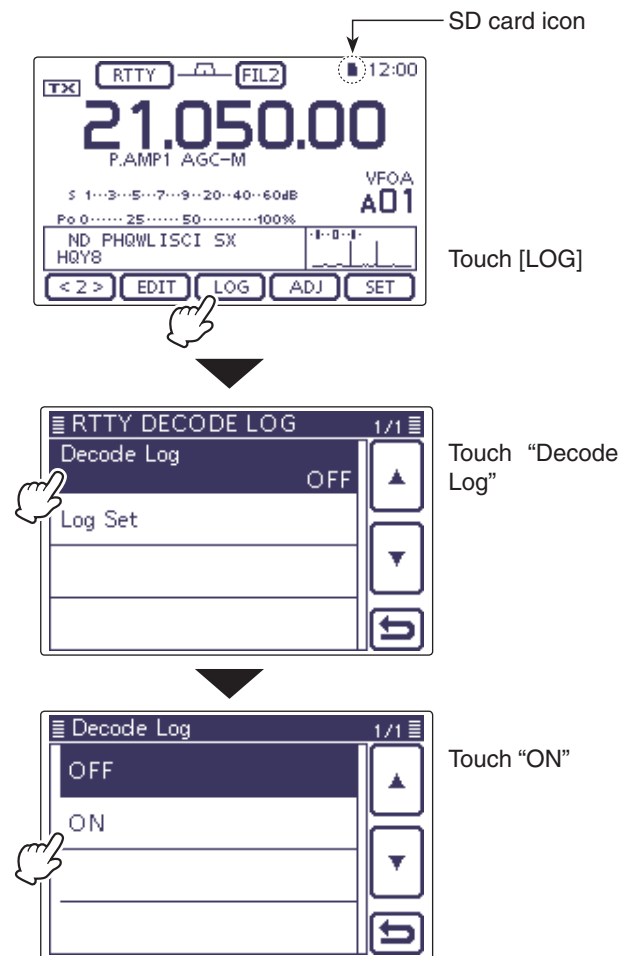

The functions for RTTY operation (Continued)

◇ RTTY decode log Set mode

The RTTY decode log Set mode is used to set the File Type and the Time stamps.

- ① In the RTTY mode, push **[MENU]**(C) one or more times to select the “M-2” screen (M-2 menu).
- ② Touch **[DEC]**(D) to display the RTTY decoder screen.
  - Touch **[WIDE]**(D) to toggle the decode screen size between normal and wide.
- ③ Touch **[<1>]**(D) to display the RTTY decoder (2) screen.
  - Touch **[<1>]** or **[<2>]**(D) to toggle between the RTTY decoder and the RTTY decode (2) screens.
- ④ Touch **[LOG]**(D) to display the “RTTY DECODE LOG” screen.
- ⑤ Touch “Log Set” to enter the “RTTY DECODE LOG SET” screen.
- ⑥ Touch the desired item to select.
  - See below for details of the set items and options.
- ⑦ Touch the desired option to change the setting.
  - If desired, touch the item for 1 second to open the Default set window, then select the “Default” to reset to the default setting.
- ⑧ Touch **[↵]**(D) or push **[MENU]**(C) to return to the “RTTY DECODE LOG” screen.
- ⑨ Touch **[↵]**(D) or push **[MENU]**(C) to return to the RTTY Decoder screen.

RTTY decode log Set mode

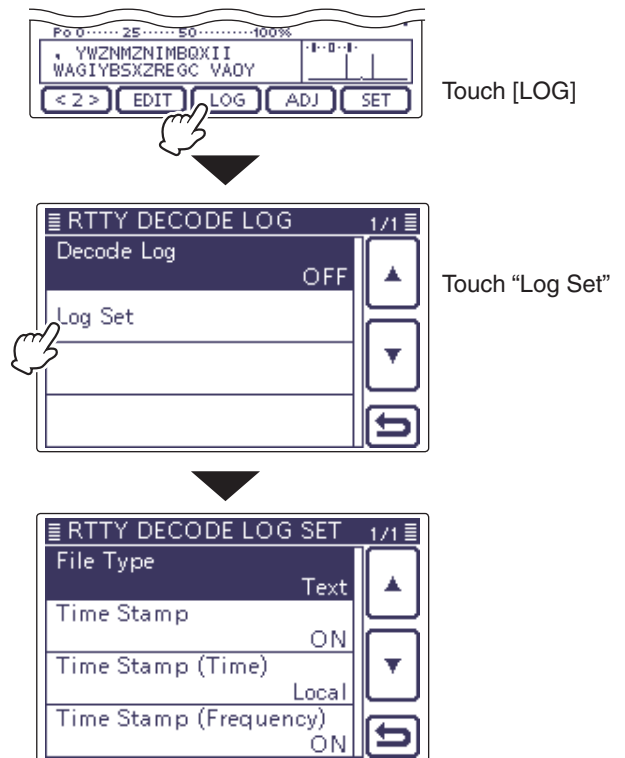

**File type** (Default: Text)

Select file type for saving a Log into an SD card, as the Text or HTML format.

- Text: Save as a Text format
- HTML: Save as an HTML format

**Time stamp** (Default: ON)

Adds the time stamp (date, transmission or reception time) to the LOG file.

- OFF: Does not save the time stamp.
- ON: Saves the date and time data.

**Time stamp (time)** (Default: Local)

Select the time of the time stamp whether it is in local or **UTC**.

**NOTE:** The time won't be saved when “OFF” is selected in “Time Stamp” to the left.

- Local: The time is used in Local time
- UTC: The time is used in UTC time

**Time stamp (frequency)** (Default: ON)

Selects the time stamp data whether adding the frequency or not.

**NOTE:** The frequency won't be saved when “OFF” is selected in “Time Stamp” to the left.

- OFF: Does not save the frequency
- ON: Saves the frequency data

## Operating AM/FM

- ① Select the desired frequency band. (p. 3-6)
- ② On the Mode selection screen, touch “AM” or “FM” to select the AM or FM mode.
  - To select the data mode, after selecting AM or FM, touch “DATA” to select the data mode, if needed.
- ③ Rotate the Dial to tune a desired signal.
  - The S-meter displays the received signal strength.
  - The tuning step can be changed on the Tuning step selection screen by touching “kHz frequency.” (p. 3-9)
- ④ Rotate [AF] (L) to adjust the audio to a comfortable listening level.
- ⑤ Push [PTT] on the microphone to transmit.
  - The TX/RX indicator lights red.
- ⑥ Speak into the microphone at your normal voice level.
- ⑦ If necessary, adjust the microphone gain or RF power on the Mic gain/RF power adjustment display.

- ① Push [MIC/RF PWR] (C) to open the MIC gain/RF power adjustment display.

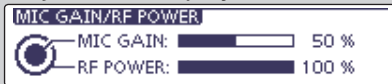

- ② Rotate [M-CH] (L) to adjust the MIC gain, or [BANK] (L) to adjust the RF power.
  - To adjust the MIC gain, adjust it with another station listening to your voice for clarity.
  - /// When the MIC gain is adjusted too high, your transmitted voice may be distorted.
- ③ Push [MENU] (C) to close the display.

- ⑧ Release [PTT] to receive.

/// **NOTE:** On the 144/440 MHz frequency band, you cannot transmit in the AM mode.

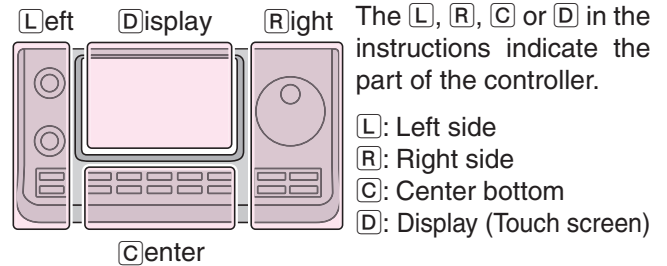

“AM” or “FM” appears

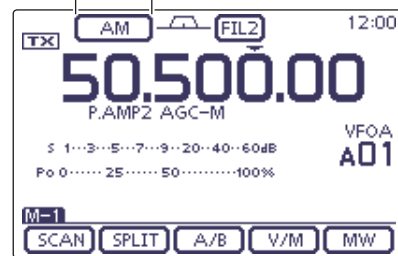

### Convenient Receive functions

- Preamp and attenuator (p. 5-2)
- Twin **PBT** (passband tuning) (p. 5-5)
  - This function is not usable in the FM mode.
- **AGC** (auto gain control) (p. 5-3)
- Noise blanker (p. 5-8)
- Noise reduction (p. 5-9)
- **Notch filter** (p. 5-10)

### Convenient Transmit functions

- **VOX** (voice operated transmit) (p. 6-2)
- Transmit quality monitor (p. 6-7, Section 17)
- Tone control (pp. 17-7, 17-23)

## Tone squelch operation

The tone squelch opens only when you receive a signal containing a matching subaudible tone. You can silently wait for calls from others using the same tone.

- ① Select the desired frequency band. (p. 3-6)
- ② On the Mode selection screen, touch “FM” to select the FM mode.
- ③ Push **MENU**(C) one or more times to select the “M-2” screen (M-2 menu).
- ④ Touch **[TONE]**(D) one or more times to turn ON the **Tone squelch function**.
  - “TSQL” appears.
  - Touch **[TONE]**(D) to toggle between “TONE,” “TSQL,” “DTCS” and OFF (icon disappears).
- ⑤ Touch **[TONE]**(D) for 1 second to display the “TONE” screen.
  - “TSQL Tone” appears.
- ⑥ Rotate the Dial to select the desired tone squelch frequency. See the table shown below.
  - If desired, touch **[DEF]** for 1 second to reset to the default setting.
- ⑦ Push **MENU**(C) to exit the “TONE” screen.
- ⑧ Communicate in the usual manner.
  - The tone squelch opens only when you receive a signal containing a matching subaudible tone.
  - Subaudible tones are superimposed on your transmit signal.

• **Available tone squelch frequencies** (Unit: Hz)

67.0	88.5	114.8	151.4	177.3	203.5	250.3
69.3	91.5	118.8	156.7	179.9	206.5	254.1
71.9	94.8	123.0	159.8	183.5	210.7	
74.4	97.4	127.3	162.2	186.2	218.1	
77.0	100.0	131.8	165.5	189.9	225.7	
79.7	103.5	136.5	167.9	192.8	229.1	
82.5	107.2	141.3	171.3	196.6	233.6	
85.4	110.9	146.2	173.8	199.5	241.8	

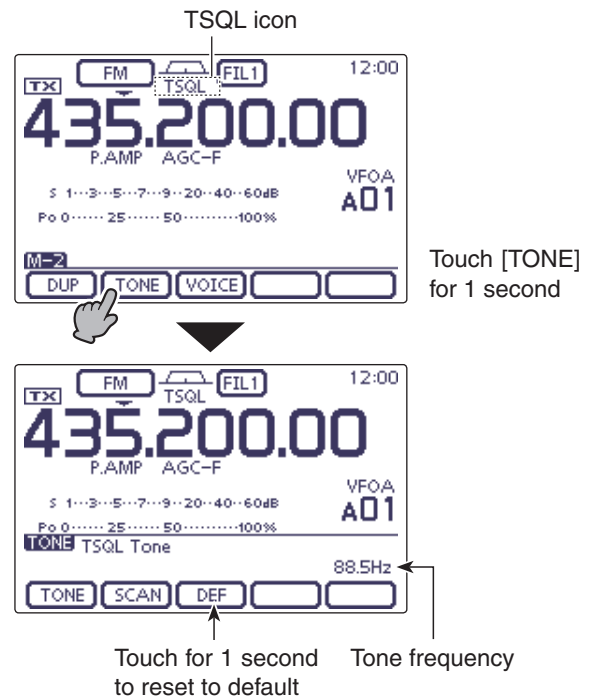
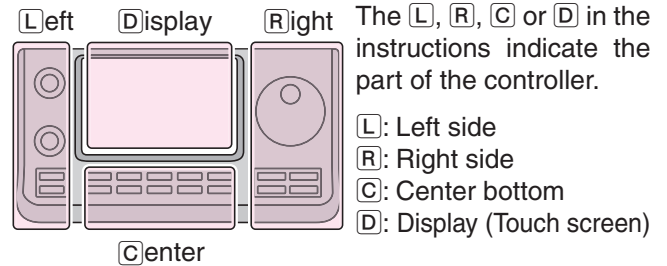

## DTCS operation

The **DTCS** function is another method of communications using selective calling. Only received signals having a matching 3-digit code will open the squelch.

- ① Select the desired frequency band. (p. 3-6)
- ② On the Mode selection screen, touch “FM” to select the FM mode.
- ③ Push **[MENU]**(C) one or more times to select the “M-2” screen (M-2 menu).
- ④ Touch **[TONE]**(D) one or more times to turn ON the DTCS function.
  - “DTCS” appears.
  - Touch **[TONE]**(D) to toggle between “TONE,” “TSQL,” “DTCS” and OFF (icon disappears).
- ⑤ Touch **[TONE]**(D) for 1 second to display the “TONE” screen.
  - “DTCS Code” appears.
- ⑥ Rotate the Dial to select the desired DTCS code number. And touch **[POL]**(D) to select the desired code polarity.
  - NN: Normal polarity is used for both transmit and receive. (Default)
  - NR: Normal polarity is used for transmit, reversed polarity is used for receive.
  - RN: Reversed polarity is used for transmit, normal polarity is used for receive.
  - RR: Reversed polarity is used for both transmit and receive.
  - If desired, touch **[DEF]** for 1 second to reset to the default setting.
- ⑦ Push **[MENU]**(C) to exit the “TONE” screen.
- ⑧ Communicate in the usual manner.
  - The tone squelch opens only when you receive a signal containing a matching subaudible tone.
  - Subaudible tones are superimposed on your transmit signal.

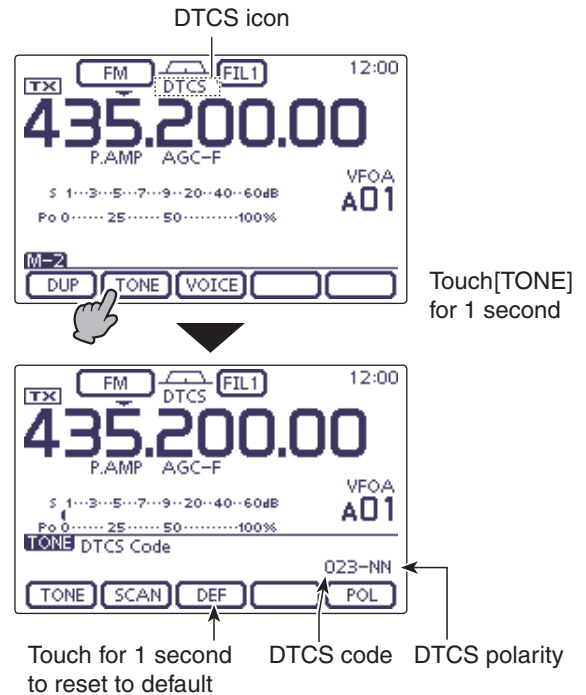

### • Available DTCS codes

023	054	125	165	245	274	356	445	506	627	732
025	065	131	172	246	306	364	446	516	631	734
026	071	132	174	251	311	365	452	523	632	743
031	072	134	205	252	315	371	454	526	654	754
032	073	143	212	255	325	411	455	532	662	
036	074	145	223	261	331	412	462	546	664	
043	114	152	225	263	332	413	464	565	703	
047	115	155	226	265	343	423	465	606	712	
051	116	156	243	266	346	431	466	612	723	
053	122	162	244	271	351	432	503	624	731	

## Tone scan/DTCS code scan operation

To search for a repeater's sub-audible tone frequency, a tone scan is available.

By monitoring a repeater signal with a tone squelch or DTCS, you can determine the tone frequency necessary to open the repeater or the squelch.

- ① Select the desired frequency band. (p. 3-6)
- ② On the Mode selection screen, touch "FM" to select the FM mode.
- ③ Push **MENU**(C) one or more times to select the "M-2" screen (M-2 menu).
- ④ Touch **[TONE]**(D) for 1 second to display the "TONE" screen.
- ⑤ Touch **[TONE]**(D) one or more times to select the tone type to be scanned.
  - "Repeater Tone" for a repeater tone, "TSQL Tone" for tone squelch or "DTCS Code" for a DTCS code, appears.
  - When selecting a DTCS code to be scanned, the DTCS code and its polarity is displayed. You can select the desired polarity by pushing **[POL]**(D).
  - "NN": Normal polarity for both transmit and receive.
  - "NR": Normal polarity for transmit and reverse polarity for receive.
  - "RN": Reverse polarity for transmit and normal polarity for receive.
  - "RR": Reverse polarity for both transmit and receive.
- ⑥ Touch **[SCAN]**(D) to start the Tone or DTCS scan.
  - "Repeater Tone SCAN," "TSQL Tone SCAN" or "DTCS Code SCAN" blinks, depending on the type you selected.
  - If the squelch is open while scanning, the scan speed decreases.
  - If "Up/Down" is selected as the "MAIN DIAL (SCAN)" option in the Scan Set mode, rotating the Dial changes the scanning direction. (p. 12-5)
- ⑦ When a matched tone or code is found, the scan pauses, and the detected subaudible tone frequency or DTCS code is set.
  - If desired, touch **[DEF]** for 1 second to reset to the default setting.
- ⑧ Touch **[SCAN]**(D) to cancel the scan.

When the tone scan or DTCS code scan is used in the Memory or Call channel mode, the detected tone frequency or code can be temporarily used. To save the detected tone frequency or code setting, you must overwrite the Memory or Call channel data.

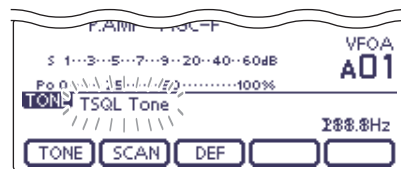
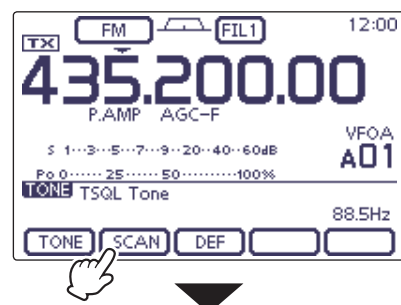
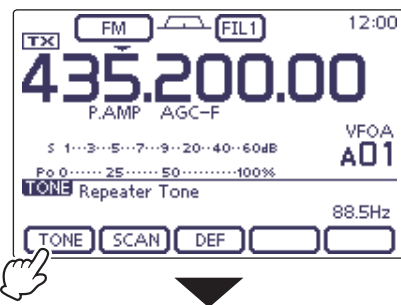
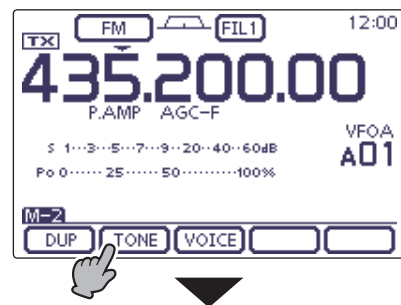
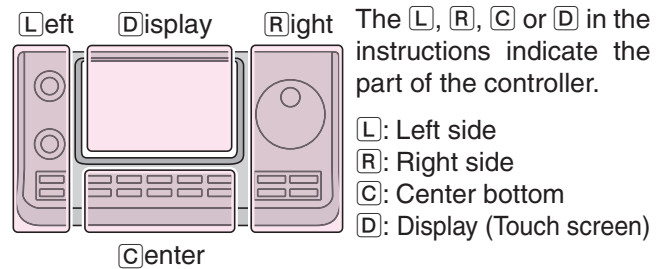

## Repeater operation

A **repeater** receives transmitted signals and retransmits them on a different frequency. When using a repeater, the transmit frequency is shifted from the receive frequency by a frequency offset.

A repeater can be accessed using the **duplex** function by setting the frequency shift to the same value as the repeater's frequency offset.

See Section 7, Section 8 and Section 9 for details on accessing a **D-STAR®** repeater.

- ① Touch the Memory channel indication once or twice to select the VFO mode.
- ② Select the desired frequency band. (p. 3-6)
- ③ On the Mode selection screen, touch "FM" to select the FM mode.
- ④ Rotate the Dial to set the receive frequency (Repeater output frequency).

When the Auto Repeater function is turned ON (available in only the U.S.A. and Korea versions), steps ⑤ and ⑥ are not necessary. (p. 4-29)

- ⑤ Push **MENU**(C) one or more times to display the "M-2" screen (M-2 menu), then touch **[DUP]**(D) one or more times to set the offset direction.
  - "DUP-" or "DUP+" appears.
  - The transmit frequency (repeater input frequency) appears above the function menu.
  - The frequency offset (amount of shift) can be set in the "DUP Offset" item of the Function Set. (p. 17-19)
- ⑥ Touch **[TONE]**(D) to turn ON the repeater tone.
  - "TONE" appears.
  - The tone frequency can be set in the "TONE" screen. 88.5 Hz is set by default. (p. 4-26)
- ⑦ Communicate in the normal way.
  - Subaudible tones are superimposed on your transmit signal.

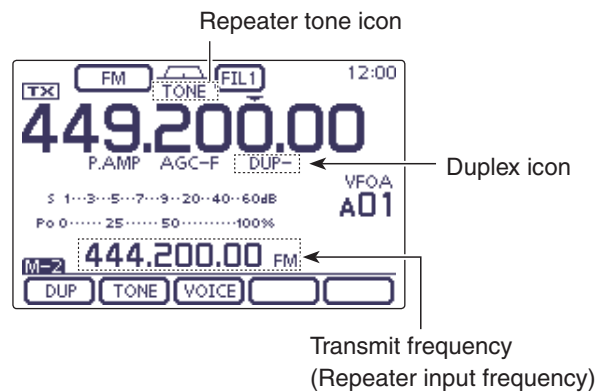
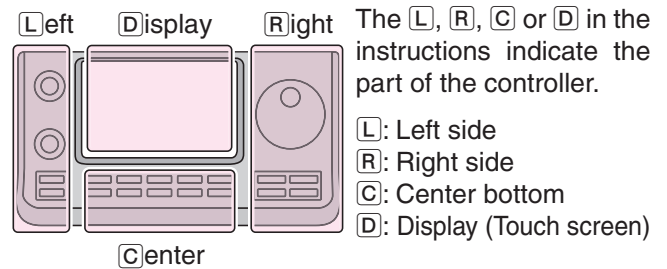

### Frequency Offset setting

The frequency offset (amount of shift) can be set in the "DUP Offset" item of the Function Set. (p. 17-19)

**SET**(C) > Function > SPLIT/DUP > **DUP Offset**

<b>Frequency offset</b>
5.0000 MHz

If the Repeater tone frequency or the frequency offset is changed, the tone frequency or frequency offset for auto repeater function is also changed.



Repeater operation (Continued)

◆ Repeater access tone frequency setting

Some repeaters require a subaudible tone to be accessed. Subaudible tones are superimposed on your normal signal and must be set first. You can select 50 tones from 67.0 Hz to 254.1 Hz.

- ① In the FM mode, push **MENU**(C) one or more times to select the “M-2” screen (M-2 menu).
- ② Touch **[TONE]**(D) one or more times to turn ON the Tone encoder function.
  - “TONE” appears.
  - Touch **[TONE]**(D) to toggle between “TONE,” “TSQL,” “DTCS” and OFF (icon disappears).
- ③ Touch **[TONE]**(D) for 1 second to display the “TONE” screen.
  - “Repeater Tone” appears.
- ④ Rotate the Dial to select the desired tone squelch frequency. See the table below.
  - If desired, touch **[DEF]** for 1 second to reset to the default setting.
- ⑤ Push **MENU**(C) to exit the “TONE” screen.
- ⑥ Communicate in the normal way.
  - Subaudible tones are superimposed on your transmit signal.

• Selectable tone frequencies (Unit: Hz)

67.0	88.5	114.8	151.4	177.3	203.5	250.3
69.3	91.5	118.8	156.7	179.9	206.5	254.1
71.9	94.8	123.0	159.8	183.5	210.7	
74.4	97.4	127.3	162.2	186.2	218.1	
77.0	100.0	131.8	165.5	189.9	225.7	
79.7	103.5	136.5	167.9	192.8	229.1	
82.5	107.2	141.3	171.3	196.6	233.6	
85.4	110.9	146.2	173.8	199.5	241.8	

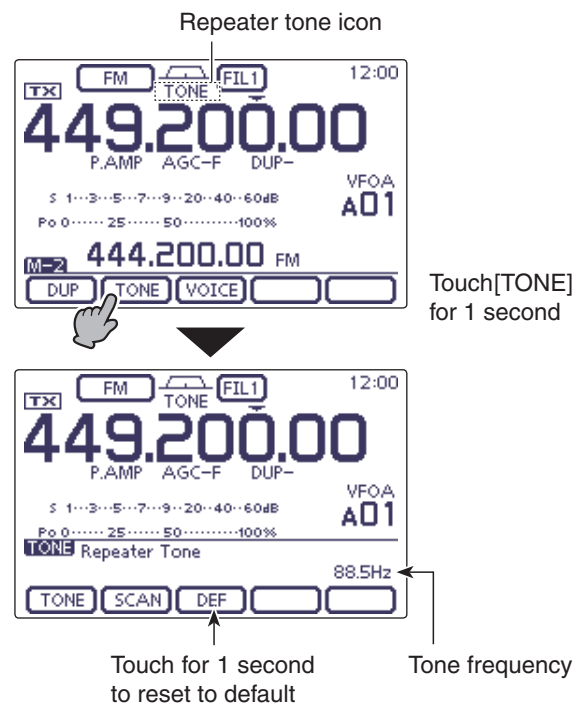
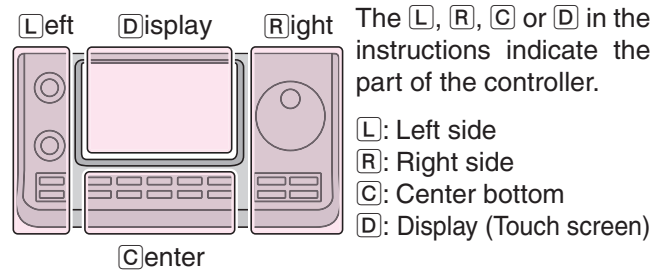



Repeater operation (Continued)

◇ **One-touch repeater function**

This function allows you to set the repeater operation by holding down one switch.

First, set the frequency offset as well as the repeater access tone frequency (p. 4-26).

- ① Touch the Memory channel indication once or twice to select the VFO mode.
- ② Select the desired frequency band. (p. 3-6)
- ③ On the Mode selection screen, touch “FM” to select the FM mode.
- ④ Rotate the Dial to set the receive frequency (Repeater output frequency).
- ⑤ Push **[MENU]**(C) one or more times to display the “M-2” screen (M-2 menu), then touch **[DUP]**(D) for 1 second to turn ON the one touch repeater function.
  - “TONE” and “DUP-” appear.
  - The repeater receive frequency appears above the function menu.
  - The Split Frequency mode is automatically turned OFF, if it is ON.
- ⑥ Touch **[DUP]**(D) one or more times to switch the offset direction.
  - “DUP-” or “DUP+” appears.
- ⑦ Communicate in the normal way.
  - Subaudible tones are superimposed on your transmit signal.

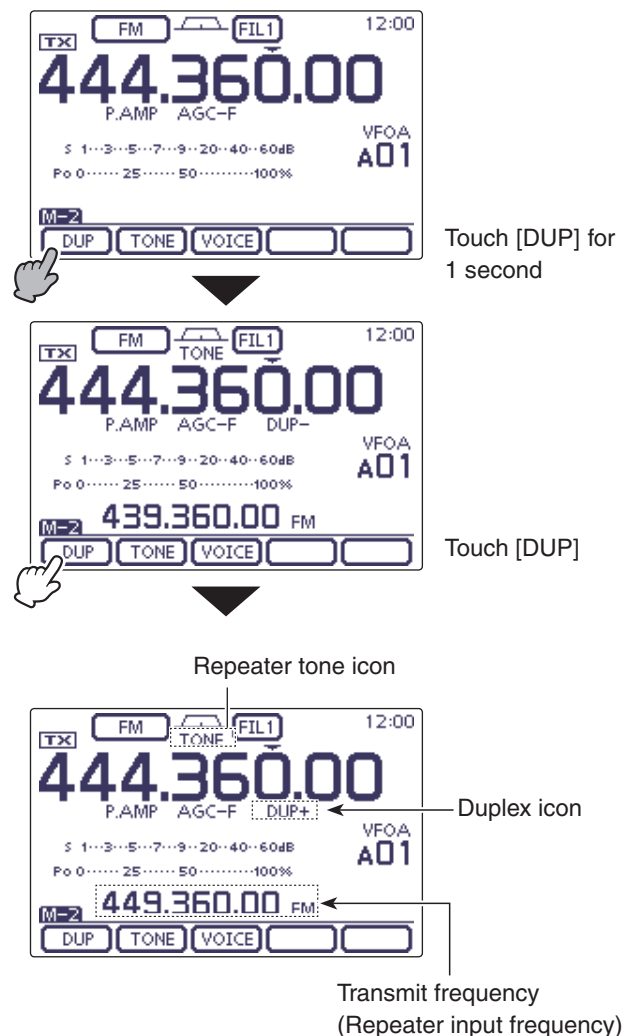
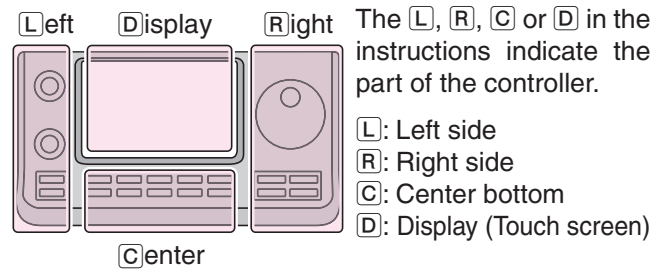

Repeater operation (Continued)

◇ **Transmit frequency monitor check**

You may be able to directly receive the other party's transmitted signal without having to go through a repeater. This function helps you to check whether direct communication can be made, or not.

- While receiving, hold down **XFC**(R) to see if you can directly receive the other party's transmitted signal.
  - While holding down **XFC**(R), the duplex direction and frequency offset are displayed above the function menu.

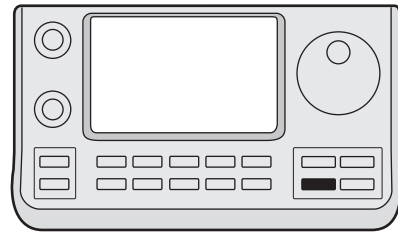

Hold down **XFC**

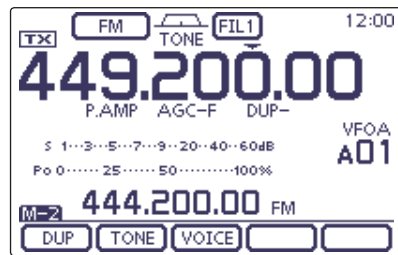

• While hold down **XFC**

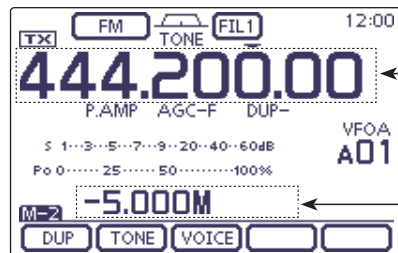

Displays the transmit frequency

Duplex direction and frequency offset

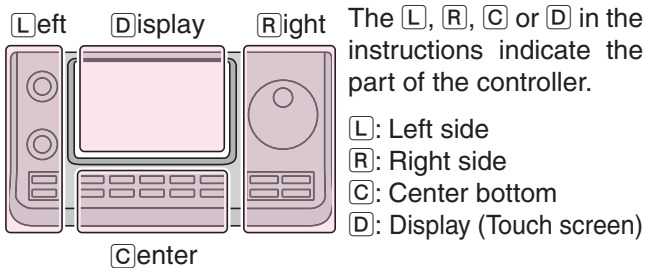

◇ **1750 Hz tone burst**

A 1750 Hz tone is required to access most European repeaters.

- ① In the FM mode, push **MENU**(C) one or more times to select the "M-2" screen (M-2 menu).
- ② Push **PTT** on the microphone to transmit, and then touch **TONE**(D) during repeater access.
  - "1750Hz TONE" appers.
- ③ Communicate in the normal way.

• While hold down **[PTT]**

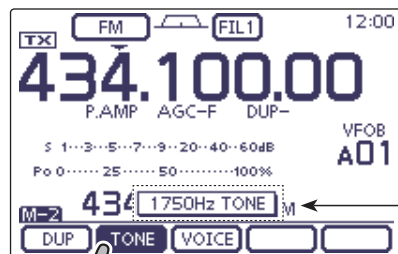

Popup window appears

Repeater operation (Continued)

◇ Turning ON the Auto Repeater function  
(U.S.A. and Korea versions only)

When the operating frequency falls within the repeater output frequency range, the Auto Repeater function automatically sets the repeater settings (duplex ON/OFF, duplex direction, tone encoder ON/OFF).

- ① Push **SET**(C) to enter the Set mode.
- ② Touch the "Auto Repeater" item of the "Function" Set mode.  
Function > SPLIT/DUP > **Auto Repeater**  
• If the specified item is not displayed, touch [▲] or [▼](D) one or more times to select the page.
- ③ Touch the desired option to turn ON the Auto Repeater function.  
**U.S.A. version:**
  - "ON-1" Activates duplex only.
  - "ON-2" Activates duplex and tone.
  - "OFF" Auto repeater function is turned OFF.**Korea version:**
  - "ON" Activates duplex and tone.
  - "OFF" Auto repeater function is turned OFF.
- ④ Push **SET**(C) to exit the Set mode.

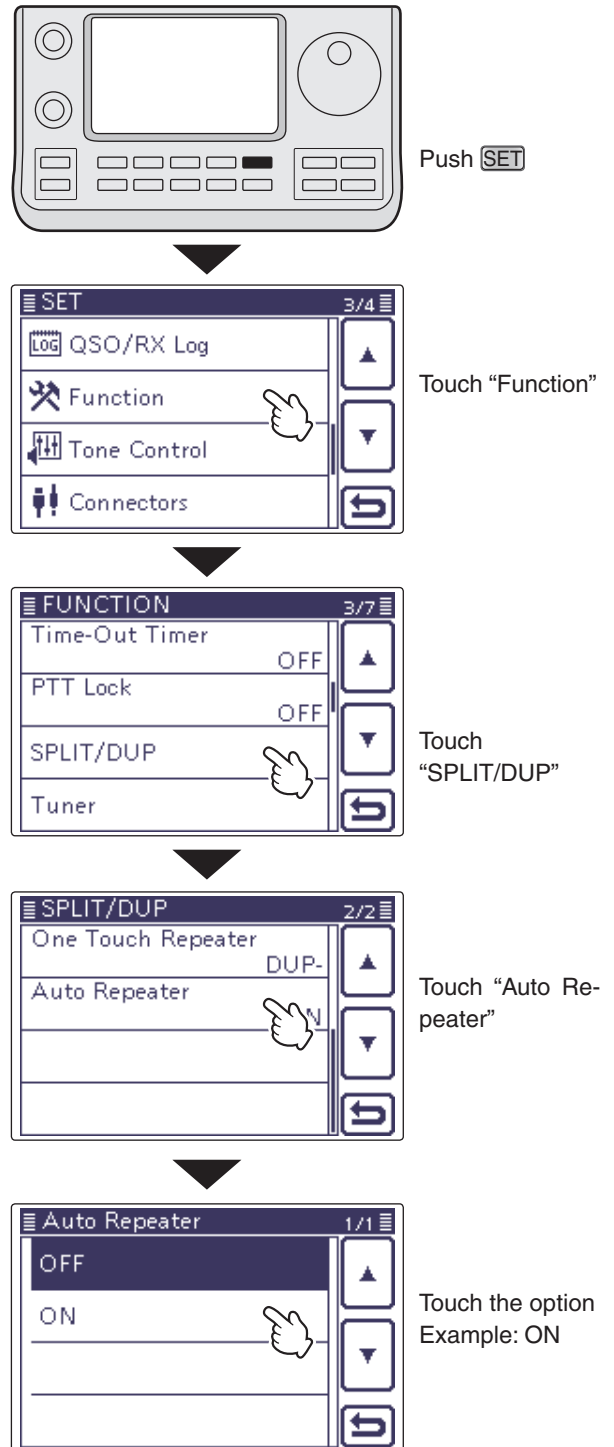
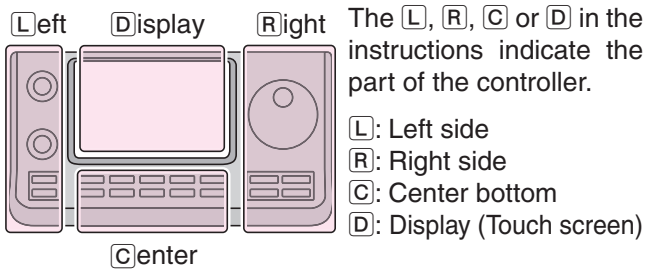

Repeater operation (Continued)

◆ Storing a non standard repeater

- ① Turn OFF the Auto Repeater function in the Set mode. (p. 4-29)  
 [SET](C) > Function > SPLIT/DUP > **Auto Repeater**
- ② While the “M-1” menu is selected, touch [A/B](D) to select VFO A.
- ③ Rotate the Dial to set the repeater output frequency.
- ④ Touch [A/B](D) to select VFO B.
- ⑤ Rotate the Dial to set the repeater input frequency.
- ⑥ Push [MENU](C) to display the “M-2” screen (M-2 menu), then touch [TONE](D) to turn ON the previously set tone encoder.
- ⑦ Push [MENU](C) to display the “M-1” screen (M-1 menu), then touch [A/B](D) to select VFO A.
- ⑧ Touch [SPLIT](D) to turn ON the **Split** function.
- ⑨ Rotate [M-CH](L) to select the desired memory channel.
  - “BLANK” appears when a blank channel is selected.
  - Rotate [BANK](L) to select the desired bank, if needed.
- ⑩ Touch [MW](D) for 1 second to store the set contents into the selected memory channel.

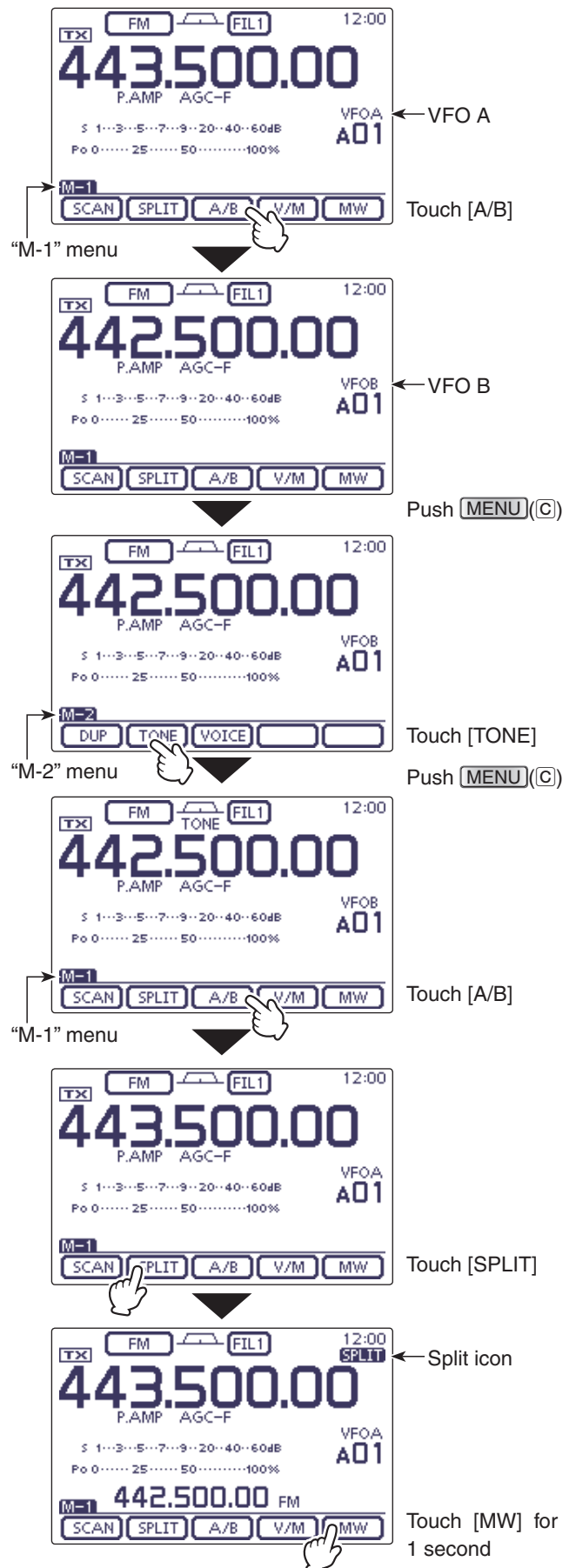
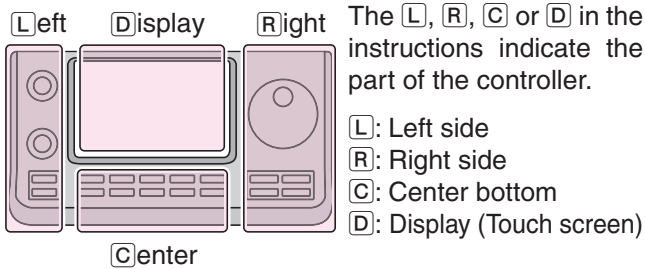

<b>Preamp and attenuator .....</b>	<b>5-2</b>
◇ Preamplifier .....	5-2
◇ Attenuator.....	5-2
<b>AGC function.....</b>	<b>5-3</b>
◇ AGC speed selection.....	5-3
◇ Setting the AGC time constant .....	5-3
<b>RIT function.....</b>	<b>5-4</b>
<b>Twin PBT operation .....</b>	<b>5-5</b>
<b>IF filter selection .....</b>	<b>5-6</b>
◇ IF filter selection .....	5-6
◇ Filter passband width setting.....	5-6
<b>IF (DSP) filter shape .....</b>	<b>5-7</b>
<b>Noise Blanker.....</b>	<b>5-8</b>
◇ NB Set mode .....	5-8
<b>Noise Reduction .....</b>	<b>5-9</b>
<b>Notch function .....</b>	<b>5-10</b>
◇ Auto Notch function .....	5-10
◇ Manual Notch function.....	5-11
<b>Lock function .....</b>	<b>5-12</b>
◇ Selecting the Lock type .....	5-12
<b>Meter peak hold function .....</b>	<b>5-13</b>
<b>Simple Band Scope .....</b>	<b>5-14</b>

## Preamp and attenuator

### ◇ Preamplifier

The preamplifier amplifies weak signals in the receiver front end, to improve the S/N ratio and **sensitivity**. Turn this function ON when receiving weak signals.

#### (Frequency band: HF, 50/70 MHz)

- ➔ Push **P.AMP/ATT**(**C**) one or more times to set the preamp OFF, preamp 1 ON or preamp 2 ON.
  - Either “P.AMP1” or “P.AMP2” is displayed when the preamp 1 or preamp 2 is ON.
  - No icon is displayed when the preamplifier is OFF.

<b>P.AMP1</b>	Wide dynamic range preamplifier. It is most effective for the 1.8 to 21 MHz bands.
<b>P.AMP2</b>	High-gain preamplifier. It is most effective for the 24 to 70 MHz bands.

#### (Frequency band: 144/430 MHz)

- ➔ Push **P.AMP/ATT**(**C**) turn the Preamplifier ON or OFF.
  - “P.AMP” appears when the preamplifier is ON.
  - No icon is displayed when it’s OFF.

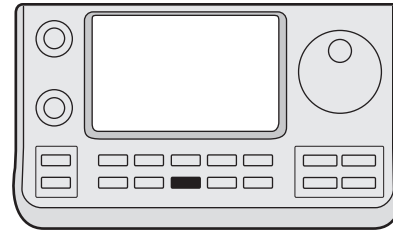

**P.AMP/ATT**

#### ✓ About the “P.AMP2” preamplifier

The preamp 2 is a high gain receive amplifier. When it is used in the presence of strong electromagnetic fields, distortion sometimes results. In such cases, use either the “P.AMP1” or “P.AMP OFF” setting.

Preamp 2 is most effective when:

- Used on bands above 24 MHz and when signals are weak.
- Receive sensitivity is insufficient when using low-gain antennas, or while using a narrow band antenna. (such as small loop, a Beverage antenna or a short Yagi antenna)

### ◇ Attenuator

The attenuator prevents a desired signal from being distorted when very strong signals are near the signal’s frequency, or when very strong electromagnetic fields, such as from broadcast stations are near your location. These can both be independently set for each band.

- ➔ Hold down **P.AMP/ATT**(**C**) for 1 second to turn ON the Attenuator.
  - “ATT” appears on the display when the Attenuator is ON.
- ➔ Push **P.AMP/ATT**(**C**) to turn it OFF.

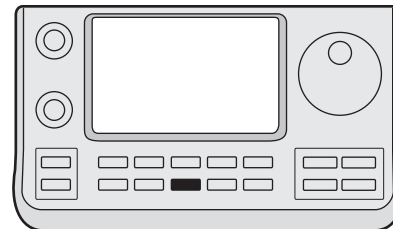

**P.AMP/ATT**

### About the Preamplifier and Attenuator switching procedure

Push or hold down **P.AMP/ATT**(**C**) to switch the Preamplifier and Attenuator, as shown below.

#### • HF, 50/70 MHz frequency bands

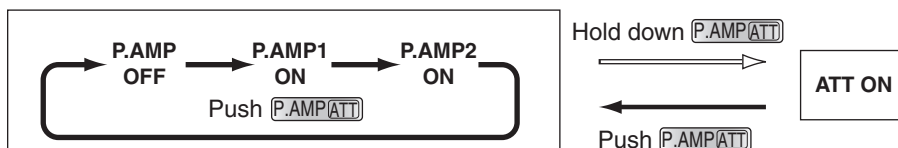

#### • 144/430 MHz frequency bands

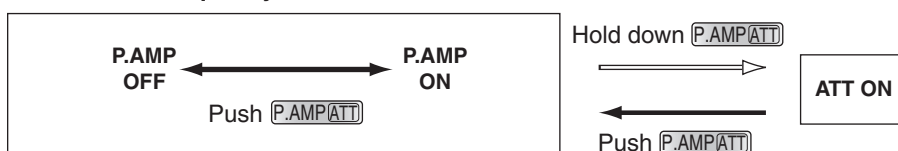

## AGC function

The **AGC** (Auto Gain Control) controls receiver gain to produce a constant audio output level, even when the received signal strength greatly varies.  
 The transceiver has 3 pre-set AGC time constants: fast, mid and slow for SSB, CW, RTTY and AM modes.

/// In the FM, WFM and DV modes, the AGC time constant is fixed as "FAST" (0.1 second).

### ◆ AGC speed selection

- ① On the Mode selection screen, select either the SSB, CW, RTTY or AM mode. (p. 3-17)
- ② Push **[MENU]**(C) one or more times to select the "M-2" screen (M-2 menu).
- ③ Touch **[AGC]**(D) to select AGC-F (FAST), AGC-M (MID) or AGC-S (SLOW).

/// "AGC OFF" appears when the selected AGC speed's time constant is set to OFF.

### ◆ Setting the AGC time constant

- ① On the Mode selection screen, select either the SSB, CW, RTTY or AM mode. (p. 3-17)
- ② Push **[MENU]**(C) one or more times to select the "M-2" screen (M-2 menu).
- ③ Touch **[AGC]**(D) for 1 second to display the "AGC" screen.
- ④ Touch either **[FAST]**, **[MID]** or **[SLOW]**(D) to select the desired AGC speed to be set.
  - The selected AGC speed's time constant is highlighted.
- ⑤ Rotate the Dial to set the selected time constant.
  - AGC time constant can be set to between 0.1 to 8.0 seconds (depending on the mode) or turned OFF.
  - If desired, touch **[DEF]**(D) for 1 second to reset to the default setting for the selected time constant.
- ⑥ If desired, select another mode (any other than the FM, WFM or DV), then repeat steps ③ and ④.
- ⑦ Push **[MENU]**(C) to exit the "AGC" screen.

#### • Selectable AGC time constant (unit: seconds)

Mode	Default	Selectable AGC time constant
SSB	0.3 (FAST)	OFF, 0.1, 0.2, 0.3, 0.5, 0.8, 1.2, 1.6, 2.0, 2.5, 3.0, 4.0, 5.0, 6.0
	2.0 (MID)	
	6.0 (SLOW)	
CW/RTTY	0.1 (FAST)	OFF, 0.1, 0.2, 0.3, 0.5, 0.8, 1.2, 1.6, 2.0, 2.5, 3.0, 4.0, 5.0, 6.0
	0.5 (MID)	
	1.2 (SLOW)	
AM	3.0 (FAST)	OFF, 0.3, 0.5, 0.8, 1.2, 1.6, 2.0, 2.5, 3.0, 4.0, 5.0, 6.0, 7.0, 8.0
	5.0 (MID)	
	7.0 (SLOW)	
FM/WFM/DV	0.1 (FAST)	Fixed

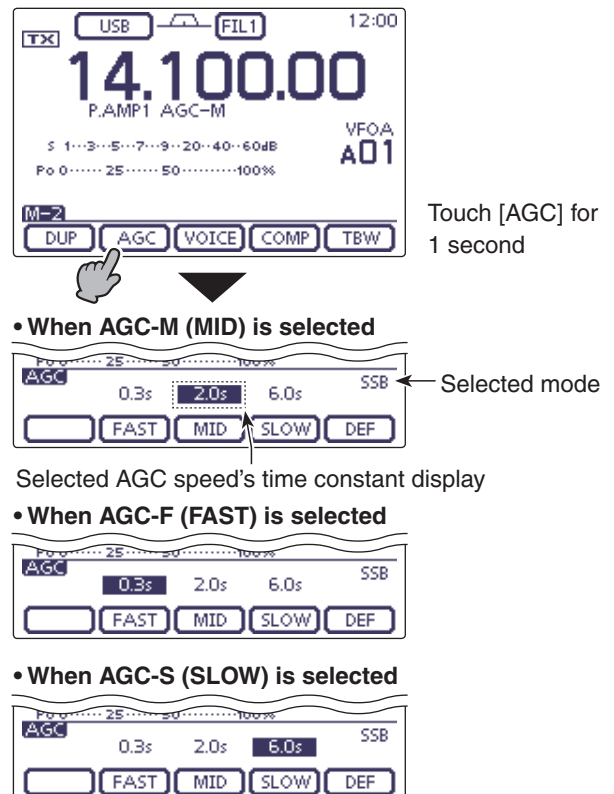
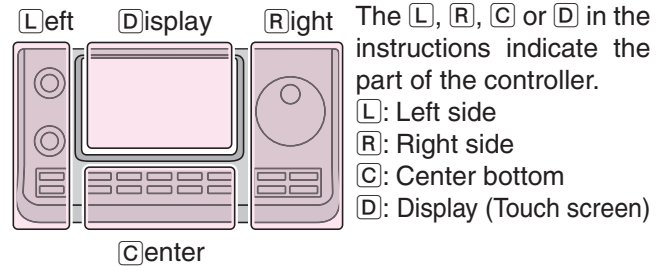

#### /// For your information

When you are receiving a weak signal, and a strong signal is momentarily received, the AGC function quickly reduces the receiver gain. When that signal disappears, the transceiver may not receive the weak signal because of the AGC action. In that case, hold down **[AGC]**(D) for 1 second, and rotate the Dial to set the time constant to OFF.

## RIT function

The RIT (Receive Increment Tuning) function compensates for off-frequency operation of the received station.

The function shifts the receive frequency up to  $\pm 9.99$  kHz in 10 Hz steps\*, without changing the transmit frequency.

\*The [M-CH] (L) control tunes in 1 Hz steps when the operating frequency readout is set to the 1 Hz step readout.

- ① Push [RIT] (L) to turn ON the RIT function.
  - “RIT” and the frequency shift appear when this function is ON.
- ② Rotate the [M-CH] (L) control.
  - When the [M-CH] (L) control acts as the RIT control, the RIT LED lights orange.
  - If the RIT LED is OFF, push the [M-CH] (L) switch one or more times to turn it ON.
  - Pushing the [M-CH] (L) switch to select the action of the [M-CH/BANK] (L) controls as the Memory/Bank selection, PBT control or RIT control.
    - When the [M-CH/BANK] (L) controls act as the PBT control, the PBT LED lights green.
    - When the [M-CH/BANK] (L) controls act as the RIT control, the RIT LED lights orange. (The RIT control is inner control. Outer control is no function.)
    - When the [M-CH/BANK] (L) controls act as the Memory/Bank selection, both LEDs are OFF.
  - Hold down [CLR] (L) for 1 second to reset the RIT frequency.
  - Hold down [RIT] (L) for 1 second to add the frequency shift to the operating frequency.
- ③ To cancel the RIT function, push [RIT] again.
  - “RIT” and the frequency shift disappear.

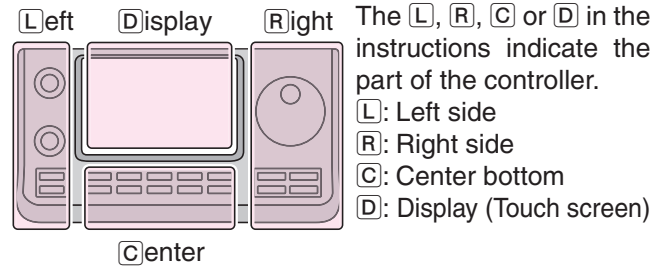

The L, R, C or D in the instructions indicate the part of the controller.

- L: Left side
- R: Right side
- C: Center bottom
- D: Display (Touch screen)

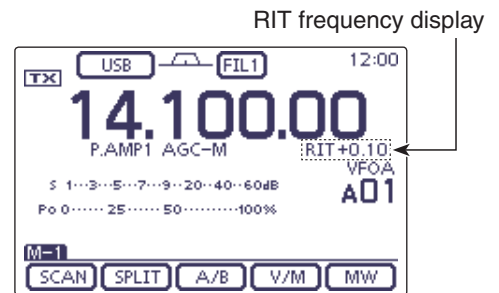
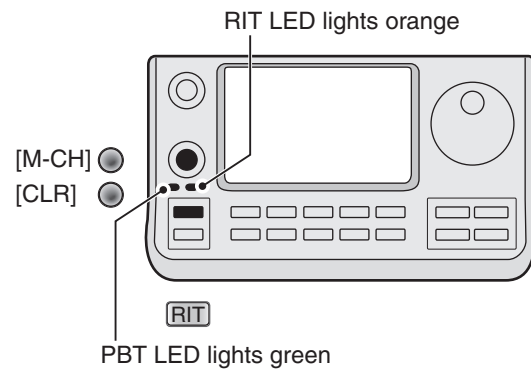



## Twin PBT operation

**(Mode: SSB/CW/RTTY/AM)**

To reject interference, PBT (Passband Tuning) electronically narrows the IF passband width by shifting the IF frequency slightly outside of the IF filter passband. The IC-7100 uses DSP for the PBT function. Moving both TWIN-PBT ([M-CH/BANK]Ⓞ(L)) controls shift the IF passband center frequency both above and below the received frequency.

- The LCD graphically shows the passband width and frequency shift.
- Touch the Filter icon for 1 second to display the “FILTER” screen. Current passband width and frequency shift are displayed in the “FILTER” screen.
- Hold down [CLR]Ⓞ(L) for 1 second to set the IF frequency to the center position.
  - The “dots” disappear.

The PBT is adjustable in 50 Hz steps in the SSB/CW/RTTY modes, and 200 Hz in the AM mode. In this time, the shift value changes in 25 Hz steps in the SSB/CW/RTTY modes, and 100 Hz in the AM mode.

- The TWIN-PBT controls should normally be set to the center positions when there is no interference. The PBT setting should be cleared.
- When the PBT is used, the audio tone may change.
- The controls do not function in the FM, WFM and DV modes.
- While rotating the TWIN-PBT ([M-CH/BANK]Ⓞ(L)) controls, noise may occur. This comes from the DSP unit and does not indicate an equipment malfunction.
- Pushing [M-CH]Ⓞ(L) displays the filter passband width and shift value for 1 second.

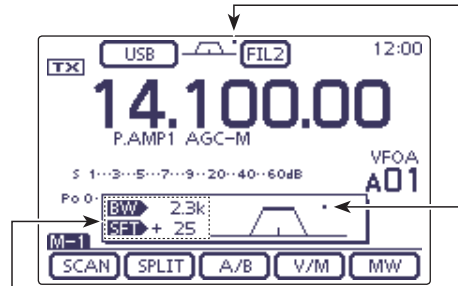

Passband width and shift value are displayed while the TWIN PBT is used. Appear when passband is shifted.

• “FILTER” screen display

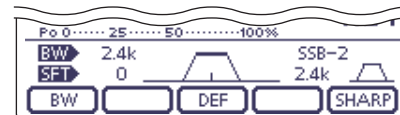

Shows the selected filter and passband width.

• While adjusting the PBT setting

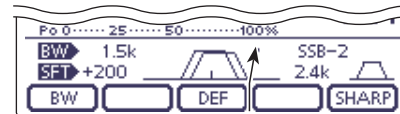

A dot appears when the passband is shifted.

• About Passband width and Shift value on the screen

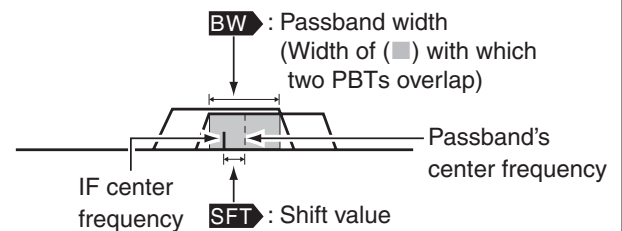

**PBT OPERATION EXAMPLE**

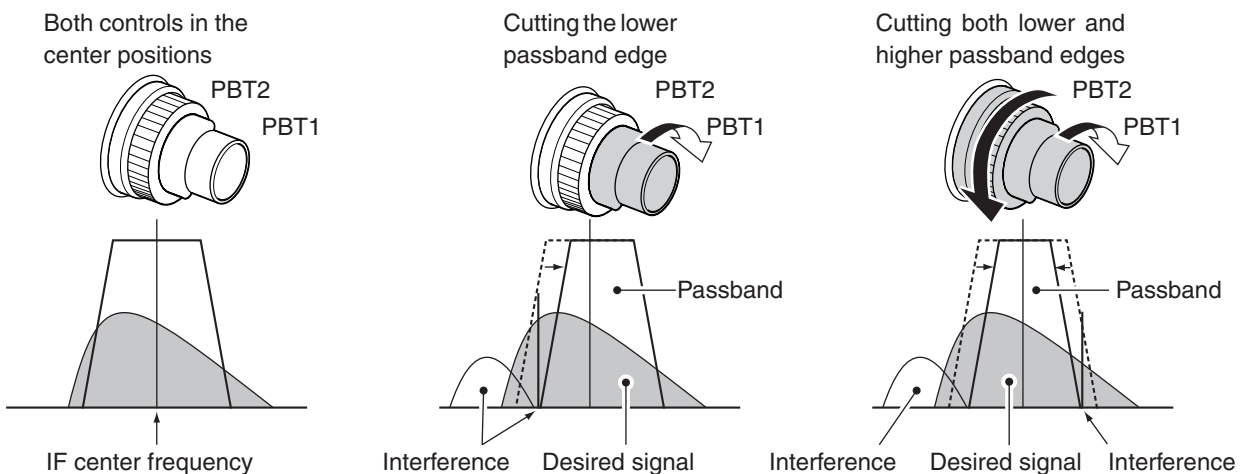

## IF filter selection

The transceiver has 3 passband width IF filters for each mode.

- ▨ The filter selection is automatically memorized in each mode.
- ▨ The PBT shift frequencies are automatically memorized in each filter.

### ◇ IF filter selection

- ① On the Mode selection screen, select the desired mode. (p. 3-17)
- ② Touch the Filter icon one or more times to select IF filter 1, 2 or 3.
  - The selected passband width and filter number is displayed as the Filter icon.

### ◇ Filter passband width setting (Mode: SSB/CW/RTTY/AM)

- ① On the Mode selection screen, select the desired mode. (p. 3-17)
  - Passband widths for FM, WFM and DV modes are fixed, and cannot be set.
- ② Touch the Filter icon for 1 second to display the “FILTER” screen to set the filter passband width.
- ③ Touch the Filter icon one or more times to select IF filter 1, 2 or 3.
- ④ Touch [BW](D), then rotate the Dial to adjust the desired passband width. Then touch [BW](D) to set it.
  - If desired, touch [DEF](D) for 1 second to reset to the default setting.
- ⑤ If desired, select another mode (any other than the FM, WFM or DV), then repeat steps ② and ④.
- ⑥ Push [MENU](C) to exit the “FILTER” screen.

Mode	IF filter	Adjustable range (steps)
SSB	FILTER1 (3.0 kHz)	50 to 500 Hz (50 Hz) 600 Hz to 3.6 kHz (100 Hz)
	FILTER2 (2.4 kHz)	
	FILTER3 (1.8 kHz)	
SSB-D CW	FILTER1 (1.2 kHz)	50 to 500 Hz (50 Hz) 600 to 3600 Hz (100 Hz)
	FILTER2 (500 Hz)	
	FILTER3 (250 Hz)	
RTTY	FILTER1 (2.4 kHz)	50 to 500 Hz (50 Hz) 600 to 2700 Hz (100 Hz)
	FILTER2 (500 Hz)	
	FILTER3 (250 Hz)	
AM AM-D	FILTER1 (9.0 kHz)	200 Hz to 10 kHz (200 Hz)
	FILTER2 (6.0 kHz)	
	FILTER3 (3.0 kHz)	
FM FM-D DV	FILTER1 (15 kHz)	Fixed
	FILTER2 (10 kHz)	
	FILTER3 (7.0 kHz)	
WFM	FILTER (280 kHz)	Fixed

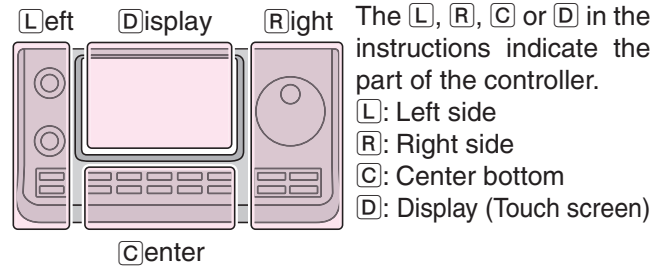

When FILTER2 or FILTER3 is selected in the FM mode, the TX modulation changes to the narrow mode (2.5 kHz).

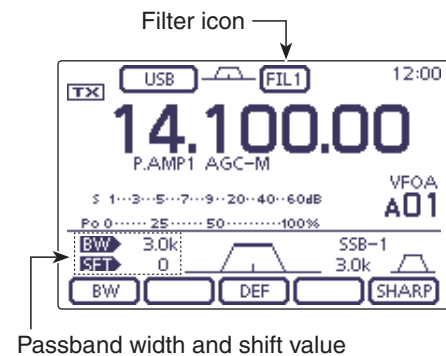

#### • “FILTER” screen display

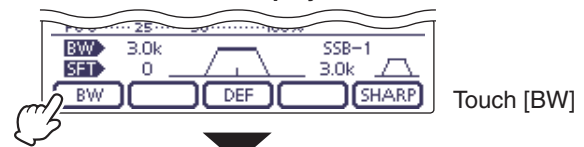

#### • While adjusting the passband width

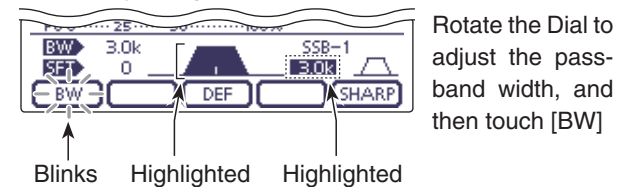

▨ The PBT shift frequencies are cleared when the passband width is changed.

▨ This “FILTER” screen graphically displays the PBT shift frequencies and passband width.

## IF (DSP) filter shape

(Mode: SSB/SSB-D/CW)

A soft or sharp type of **DSP** filter shape for both SSB and CW can be independently selected.

- ① On the Mode selection screen, select the SSB or CW mode. (p. 3-17)
- ② Touch the Filter icon for 1 second to display the "FILTER" screen.
- ③ Push [SHARP] or [SOFT](D) to select either the soft or sharp filter shape.
- ④ Push [MENU](C) to exit the "FILTER" screen.

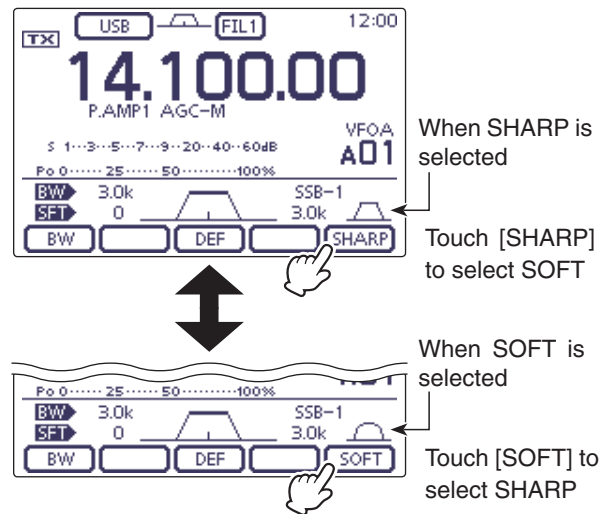
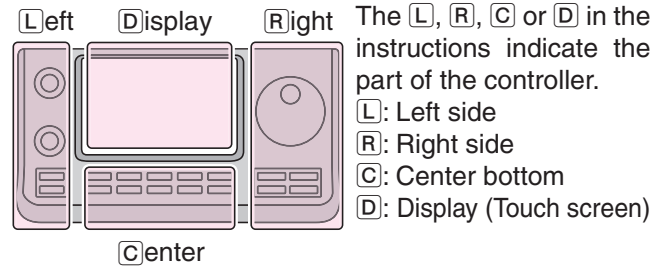

## Noise Blanker

**(Mode: SSB/CW/RTTY/AM)**

The Noise Blanker eliminates pulse-type noise such as noise from car ignitions.

- ➔ Push **[NB]**(**[D]**) to turn the Noise Blanker function ON or OFF.
  - “NB” is displayed when the Noise Blanker is ON.

When using the Noise Blanker function, received signals may be distorted if they are excessively strong or when used for noise other than pulses. In this case, set the Noise Blanker threshold level to a shallow position, or turn OFF the function. (see below)

The **[L]**, **[R]**, **[C]** or **[D]** in the instructions indicate the part of the controller.

- [L]**: Left side, **[R]**: Right side, **[C]**: Center bottom
- [D]**: Display (Touch screen)

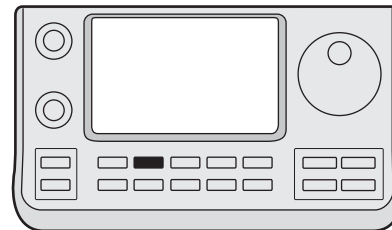

**[NB]**

NB icon

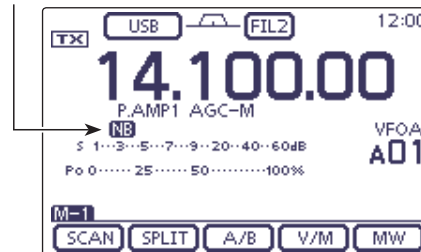

◆ **NB Set mode**

To deal with various types of noise, the attenuation level and noise blanking duration can be set in the NB set mode.

- ① Hold down **[NB]**(**[C]**) for 1 second to display the “NB” screen (Noise blanker).
- ② Touch **[▲]** or **[▼]**(**[D]**) to select the desired item.
- ③ Rotate the Dial to select the desired option.
  - If desired, touch **[DEF]**(**[D]**) for 1 second to reset to the default setting.
- ④ Push **[NB]**(**[C]**) to return to the previous screen.

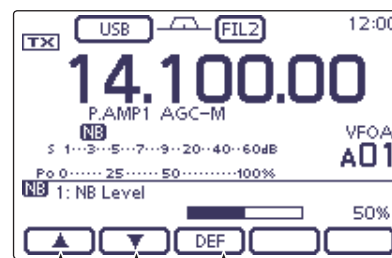

Select the item      Touch for 1 second to reset to default

**1. NB Level** (Default: 50%)

Set the noise blanker threshold level to between 0% and 100%.

**2. NB Depth** (Default: 8)

Set the noise attenuation level to between 1 and 10.

**3. NB Width** (Default: 50)

Set the blanking duration to between 1 and 100.

## Noise Reduction

The Noise Reduction function reduces random noise components and enhances audio signals which are buried in noise. The received signals are converted to digital signals and then the audio signals are separated from the noise.

- ① Push **NR**(**C**) to turn ON the Noise Reduction.
  - “NR” appears.
- ② Hold down **NR**(**C**) for 1 second to display the “NR” screen (Noise Reduction).
- ③ Rotate the Dial to adjust the Noise Reduction level; rotate it clockwise to higher reduction level or counter clockwise to lower reduction level.
  - If desired, touch **[DEF]**(**D**) for 1 second to reset to the default setting.
  - The adjustable reduction level is between 1 and 15.
- ④ Push **NR**(**C**) to exit the “NR” screen (Noise Reduction).
  - If desired, push **NR**(**C**) to turn OFF the Noise Reduction.

⚡ A large rotation of the “NR control” results in audio signal masking or distortion. Set the “NR control” for maximum readability.

### Noise reduction OFF

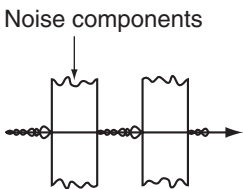

### Noise reduction ON

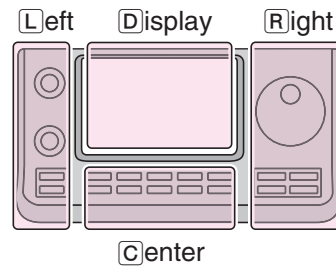
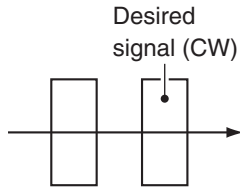

The **L**, **R**, **C** or **D** in the instructions indicate the part of the controller.  
**L**: Left side  
**R**: Right side  
**C**: Center bottom  
**D**: Display (Touch screen)

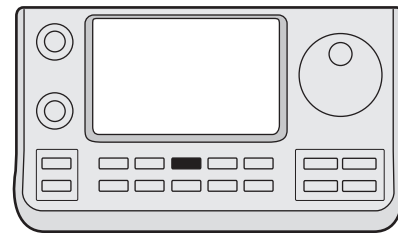

NR

### NR icon

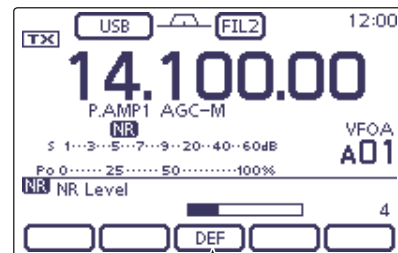
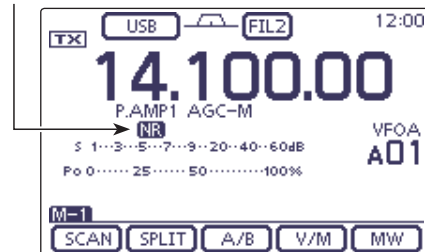

Touch for 1 second to reset to default

## Notch function

(Mode = Auto notch: SSB/AM/FM  
Manual notch:SSB/CW/RTTY/AM)

This transceiver has Auto and Manual Notch functions.

- ➔ In the SSB or AM mode, push **NOTCH**(C) to toggle the Notch function between auto, manual and OFF.
  - Either the Auto or Manual notch function can be turned OFF in the “[NOTCH] switch (SSB)” or “[NOTCH] switch (AM)” item of the “Function” Set mode. (p. 17-21)
  - SET**(C) > Function > **[NOTCH] switch (SSB)**
  - SET**(C) > Function > **[NOTCH] switch (AM)**
- ➔ In the CW or RTTY mode, push **NOTCH**(C) to turn the Manual Notch function ON or OFF.
- ➔ In the FM mode, push **NOTCH**(C) to turn the Auto Notch function ON or OFF.
  - “AN” appears when the Auto Notch function is ON.
  - “MN” appears when the Manual Notch function is ON.
  - No indicator appears when the notch filter is OFF.

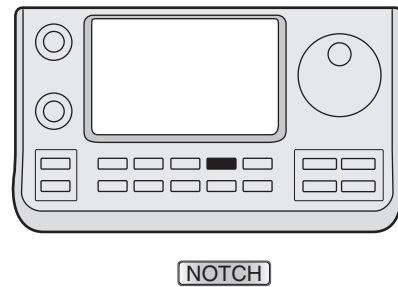
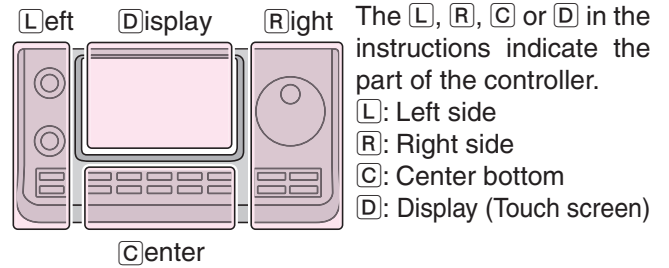

### ◇ Auto Notch function

The Auto Notch function uses **DSP** to automatically attenuate beat tones, tuning signals, and so on, even if their frequencies are changing.

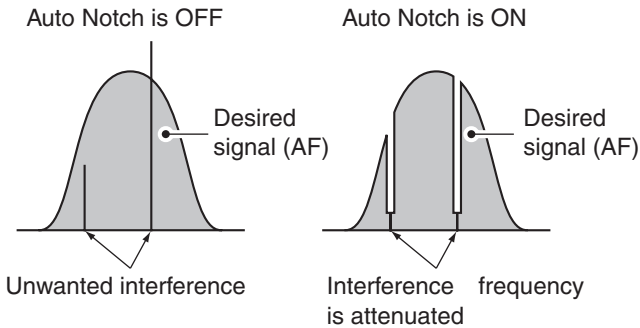

Auto Notch icon

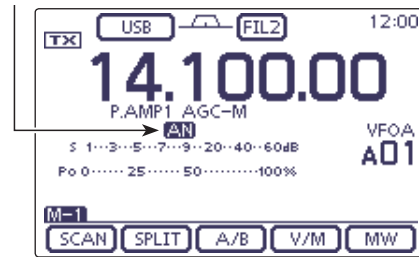

Notch function (Continued)

◇ Manual Notch function

(Mode = Manual notch:SSB/CW/RTTY/AM)

The Manual Notch function allows you to manually attenuate a frequency via the “NOTCH control.”

- ① Push **[NOTCH]**(C) once or twice to turn ON the Manual Notch function.
  - “MN” appears.
- ② Hold down **[NOTCH]**(C) for 1 second to display the “NOTCH” screen.
  - Touch **[WIDTH]**(D) to select the Manual Notch filter width, “WIDE,” “MID” or “NAR.”
- ③ Rotate the Dial to adjust the **Notch filter** frequency.
  - Since the Notch filter has the very sharp characteristic, when adjusting a filter, slowly rotate the Dial.
  - If desired, push **[NOTCH]**(C) to exit the “NOTCH” screen.

Mode	Center frequency
SSB RTTY	-1040 Hz to +4040 Hz
CW	CW pitch frequency -2540Hz to CW pitch frequency +2540Hz
AM	-5060 Hz to +5100 Hz

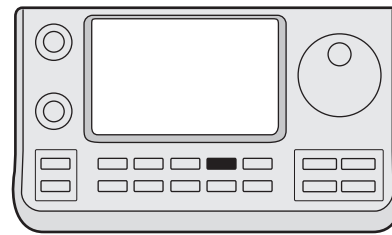
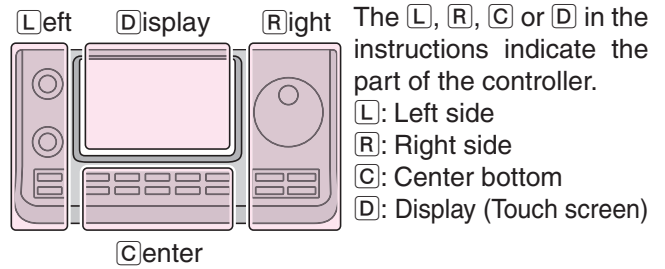
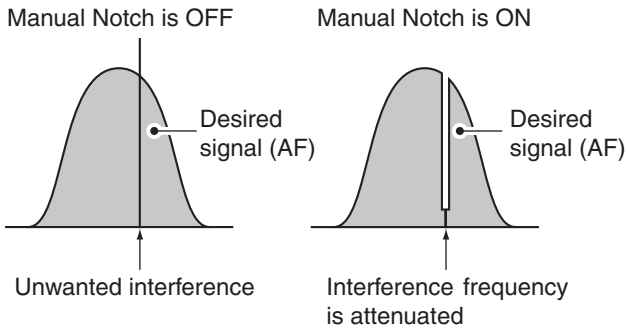

NOTCH

Manual Notch icon

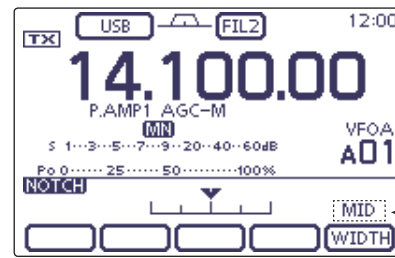
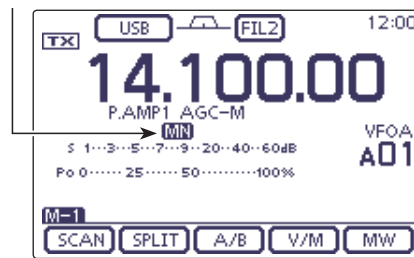

Manual Notch filter width

While tuning the manual notch filter, noise may be heard. This comes from the DSP unit and does not indicate an equipment malfunction.

## Lock function

The IC-7100 has two kinds of lock functions; Dial Lock and Panel Lock. The Dial Lock function locks only the Dial, and Panel Lock function locks controller operation.

The Dial Lock function prevents frequency changes by accidental movement of the Dial by electronically locking it. To prevent accidental frequency changes and unnecessary function access, use the Panel Lock function.

- ➔ Hold down **[SPEECH/LOCK]**(R) to turn the Lock function ON or OFF.
  - “**[LOCK]**” appears when the function is ON.

**NOTE:** When the “[SPEECH/LOCK] Switch” item of the “Function” Set mode is set to “LOCK/SPEECH,” pushing **[SPEECH/LOCK]** turns ON the Dial Lock function. (p. 17-20)

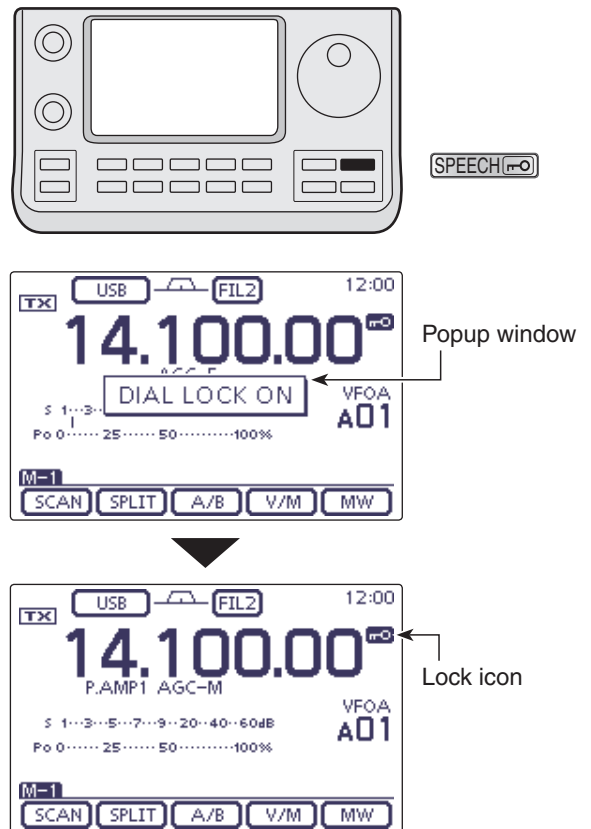
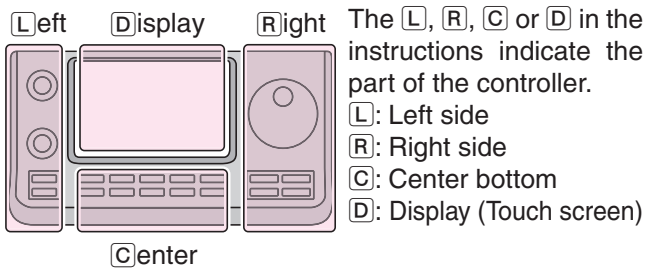

### ◇ Selecting the Lock type

The Lock function is set to MAIN DIAL by default, the setting can be changed to PANEL in the “Lock Function” item of the “Function” Set mode. (p. 17-20)

- ① Push **[SET]**(C) to enter the Set mode.
- ② Touch the “Lock Function” item of the “Function” Set mode.
  - Function > **Lock Function**
    - If the specified item is not displayed, touch **[▲]** or **[▼]**(D) one or more times to select the page.
- ③ Touch the desired option to set the Lock type.
  - MAIN DIAL: Locks only the Dial operation.
  - PANEL: Locks the Dial, controls and keys. **[SPEECH/LOCK]**(R), **[PWR/AF]**(L) and **[RF/SQL]**(L) can be used while in the Panel Lock function is ON.
- ④ Push **[SET]**(C) exit the Set mode.

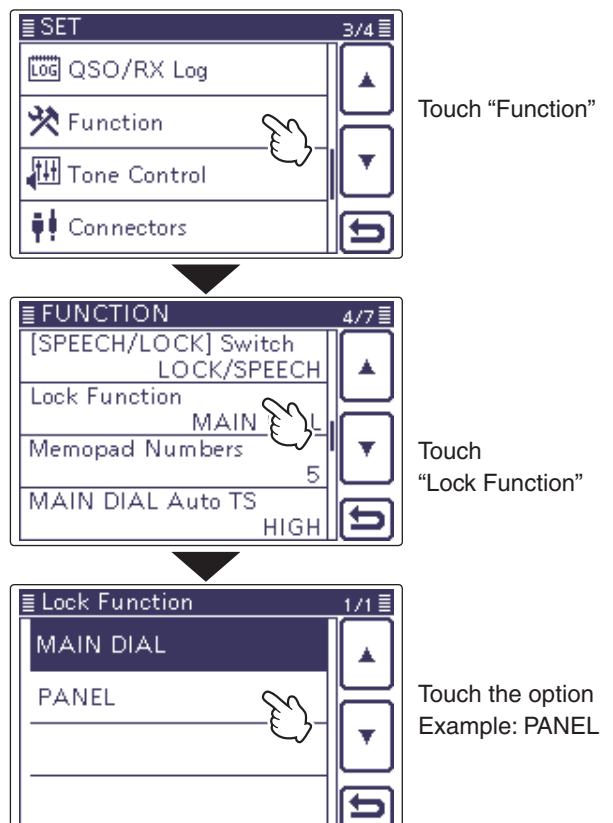



## Meter peak hold function

The Meter Peak hold function is set to ON by default, the peak level of a received signal strength or the output power is displayed for approximately 0.5 seconds. The function can be turned OFF in the “Meter Peak Hold” item of the “Display” Set mode. (p. 17-27)

- ① Push **SET**(C) to enter the Set mode.
- ② Touch the “Meter Peak Hold” item of the “Display” Set mode.  
 Display > **Meter Peak Hold**
  - If the specified item is not displayed, touch **[▲]** or **[▼]**(D) one or more times to select the page.
- ③ Touch the desired option to turn ON or OFF the Meter Peak Hold function.
- ④ Push **SET**(C) to exit the Set mode.

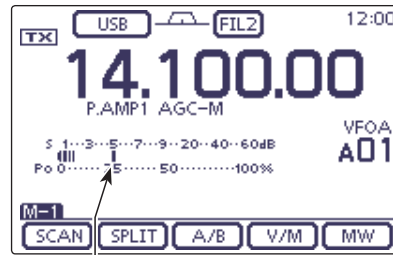

Appears for 0.5 seconds.

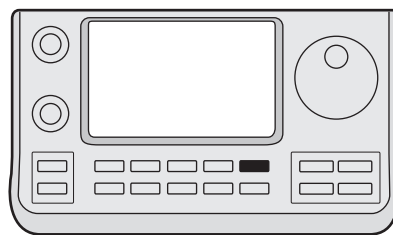

Push **SET**

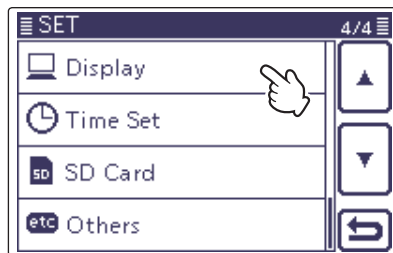

Touch “Display”

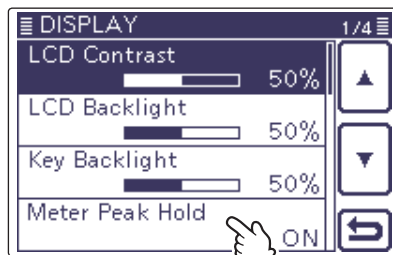

Touch “Meter Peak Hold”

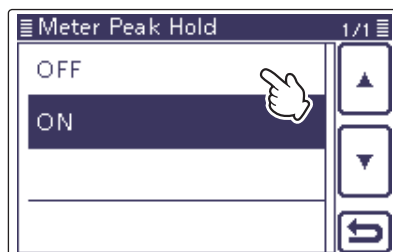

Touch the option  
Example: OFF

**L**left    **D**isplay    **R**ight

**C**enter

The **L**, **R**, **C** or **D** in the instructions indicate the part of the controller.  
**L**: Left side  
**R**: Right side  
**C**: Center bottom  
**D**: Display (Touch screen)

## Simple Band Scope

The **Band** Scope function allows you to visually check the location and strength of signals around a specified frequency.

The IC-7100's Band Scope function can be used in any operating mode and any frequency band.

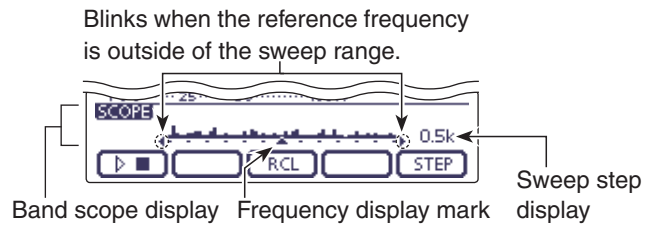

INDICATOR	DESCRIPTION
<b>Sweep icon</b>	While the band scope is sweeping, "▶□" is displayed; while stopped, "▷■" is displayed. <b>Received audio is not heard from the speaker while the band scope is sweeping.</b>
<b>Band scope display</b>	Displays the signal location and strength in relation to the center (displayed) frequency. Signal strength is relative to the S-meter level, S1 to S9+30 dB, with each vertical dot in the band scope indicators 1 to 15 dots. Between +30 dB to +60 dB are also displayed by 15 dots. Signal activity is measured ±30 steps from the center frequency, with each step equal to the selected sweep step.
<b>Frequency display mark</b>	After a sweep, displays the relative position of the reference frequency. When the reference frequency is outside of the sweep range, "⚡" or "⚡" blinks. After changing the frequency, touch [RCL](D) for 1 second to automatically return to the center frequency.
<b>Sweep step display</b>	Displays the selected sweep step. 0.5, 1, 2, 5, 10, 20 and 25 kHz are selectable. Each dot of the band scope display is equal to the selected sweep step.

The band scope measures receive signal location and strength over a specified range on either side of a selected frequency, in either the VFO or memory modes.

- Rotate the Dial to select a frequency.
- Push [MENU](C) one or more times to select the "M-3" screen (M-3 menu).
- Touch [SCOPE](D) to display the "SCOPE" screen (Band Scope).
  - Automatically starts sweeping with the previously selected sweeping step.
  - During a sweep, received signals cannot be heard.
- Touch [STEP](D) one or more times to select the desired sweep step.
  - 0.5, 1, 2, 5, 10, 20 and 25 kHz are selectable.
- Touch [▶■](D) to start sweeping, then automatically stop after sweeping.
  - Touch [▶■](D) for 1 second to start continuous sweeping. In this case, touch [▶□](D) to stop the sweeping.
  - During a sweep, "▶□" is displayed and received signals cannot be heard.
  - If there is a lot of signal noise, turn OFF the Preamplifier to reduce the signal input level, and turn ON the Attenuator to improve the readability of the band scope.
- Rotate the Dial to find a signal that you wish to communicate with. If you find the signal, communicate in the normal way.
  - If you want to return to the frequency you were using before rotating the Dial, touch [RCL](D) for 1 second.
  - If the selected frequency is set outside of the sweep range, "⚡" or "⚡" blinks.
- If you want to update the band conditions while receiving, repeat steps ④ and ⑤.

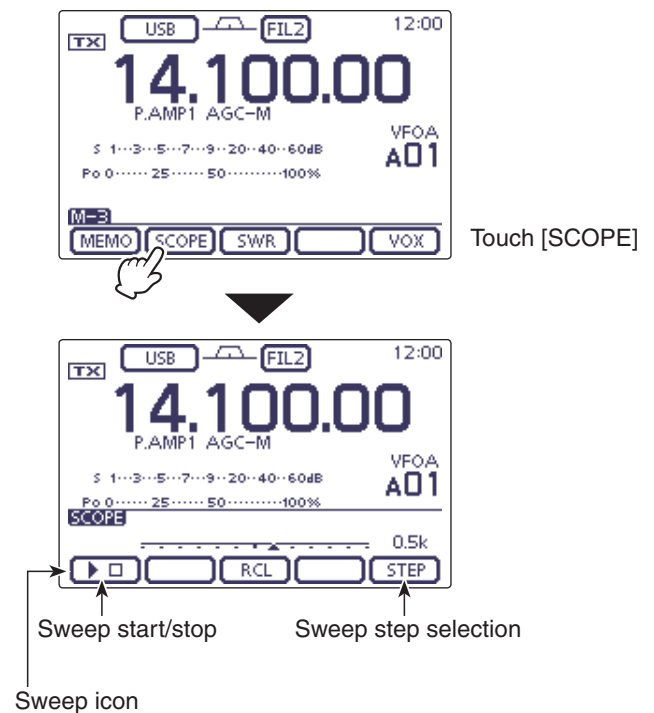

**NOTE:**  
If you select a large sweep step, a wide frequency range can be displayed on the band scope, but some signals may be skipped and not displayed.

<b>VOX function</b> .....	<b>6-2</b>
◇ Using the VOX function .....	6-2
◇ Adjusting the VOX function .....	6-2
<b>Break-in function</b> .....	<b>6-3</b>
◇ Semi Break-in operation .....	6-3
◇ Full Break-in operation .....	6-4
<b>Speech compressor function</b> .....	<b>6-5</b>
<b>Transmit filter width selection</b> .....	<b>6-6</b>
<b>Monitor function</b> .....	<b>6-7</b>
<b>Split frequency operation</b> .....	<b>6-8</b>
◇ Direct frequency shift input .....	6-9
◇ Split Lock function .....	6-10
<b>Quick Split function</b> .....	<b>6-11</b>
◇ Split frequency offset setting .....	6-12
<b>Measuring SWR</b> .....	<b>6-13</b>
◇ Spot measurement .....	6-13
◇ Plot measurement .....	6-14
◇ SWR Graph Set mode .....	6-16
<b>DTMF Memory encoder</b> .....	<b>6-17</b>
◇ Programming a DTMF code .....	6-17
◇ Transmitting DTMF code .....	6-18
◇ Transmitting DTMF code (Direct Input) .....	6-19
◇ Setting DTMF transfer speed .....	6-20

## VOX function

### (Mode: SSB/AM/FM/DV)

The VOX (Voice-Operated Transmission) function switches the transceiver between transmit and receive with your voice. This function provides hands-free operation.

### ◇ Using the VOX function

- ① Select the desired frequency band. (p. 3-6)
- ② On the Mode selection screen, select either the SSB, AM, FM or DV mode. (p. 3-17)
- ③ Push **[MENU]**(C) one or more times to select the “M-3” screen (M-3 menu).
- ④ Touch **[VOX]**(D) to turn ON the VOX function.
  - “VOX” appears.

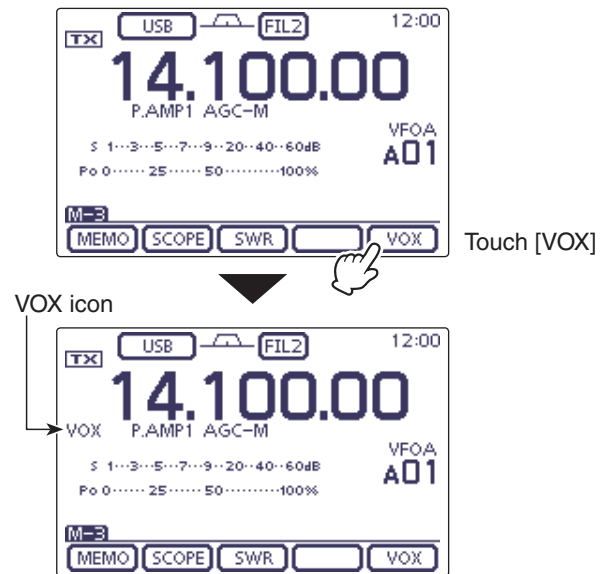
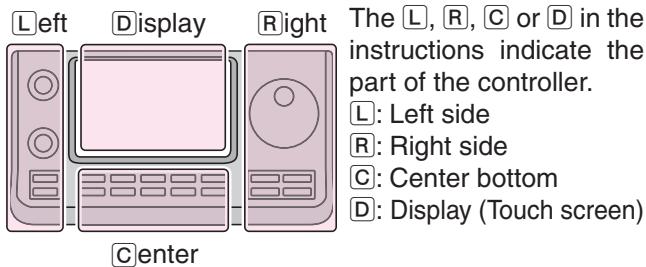

### ◇ Adjusting the VOX function

- ① On the Mode selection screen, select either the SSB, AM, FM or DV mode. (p. 3-17)
- ② Push **[MENU]**(C) one or more times to select the “M-3” screen (M-3 menu).
- ③ Touch **[VOX]**(D) for 1 second to display the “VOX” screen.
- ④ Touch **[▲]** or **[▼]**(D) to select the desired item.
- ⑤ Rotate the Dial to select the desired option.
  - If desired, touch **[DEF]**(D) for 1 second to reset to the default setting.
- ⑥ Push **[MENU]**(C) to exit the “VOX” screen.

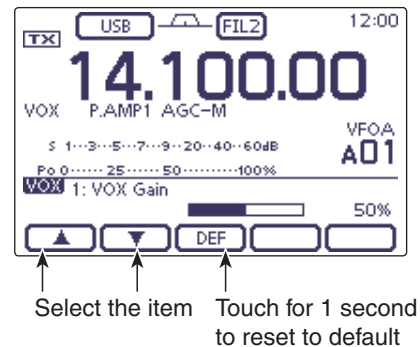

### 1. VOX Gain (Default: 50%)

Adjust the VOX gain to between 0% and 100%, in 1% steps.  
 Higher values make the VOX function more sensitive to your voice.

### 2. Anti-VOX (Default: 50%)

Adjust the ANTI-VOX gain to between 0% and 100%, in 1% steps.  
 Higher values make the VOX function less sensitive to the received audio from a speaker or headphones.

### 3. VOX Delay (Default: 0.2sec)

Set the VOX delay to between 0.0 and 2.0 seconds, for normal pauses in speech before returning to receive.

## Break-in function

**(Mode: CW)**

The Break-in function is used in the CW mode to automatically toggle the transceiver between transmit and receive when keying. The IC-7100 is capable of Full Break-in or Semi Break-in.

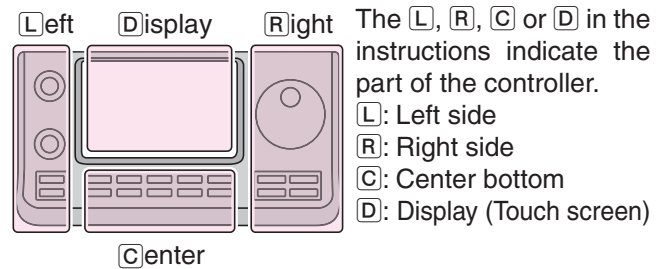

### ◆ Semi Break-in operation

During Semi Break-in operation, the transceiver immediately transmits when you key down, then returns to receive after a preset delay time has passed after you stop keying.

- ① Select the desired frequency band. (p. 3-6)
- ② On the Mode selection screen, select the CW or CW-R mode. (p. 3-17)
- ③ Push **[MENU]**(C) one or more times to select the "M-3" screen (M-3 menu).
- ④ Touch **[BK-IN]**(D) one or more times to turn ON the Semi Break-in function.
  - "BKIN" appears.
- ⑤ When the "M-3" screen (M-3 menu) is selected, touch **[BK-IN]**(D) for 1 second to display the "BK-IN" screen.
- ⑥ Rotate the Dial to select the desired option.
  - If desired, touch **[DEF]**(D) for 1 second to reset to the default setting.
- ⑦ Push **[MENU]**(C) to exit the "BK-IN" screen.

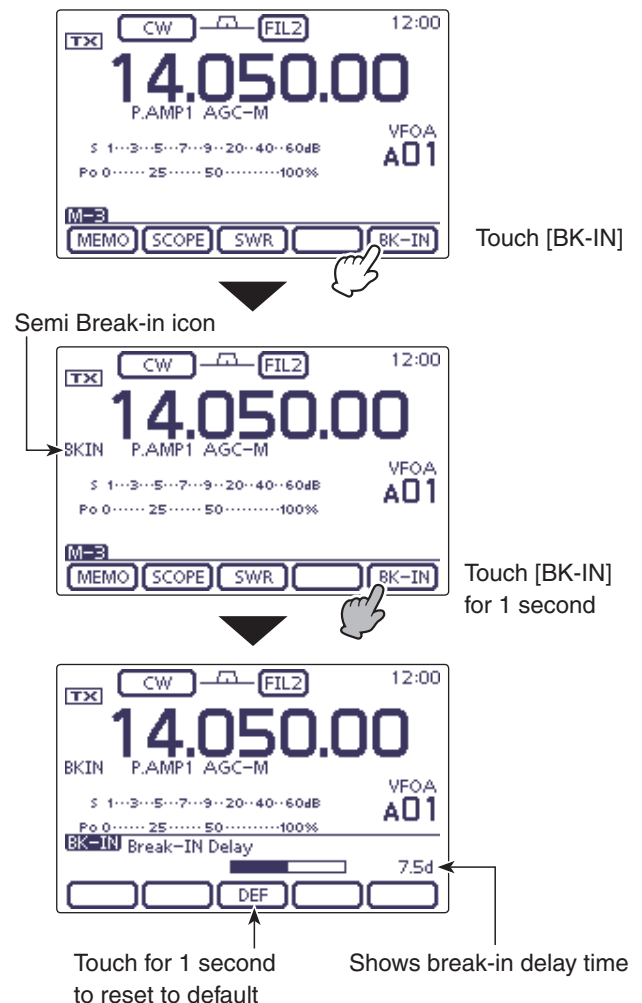

Break-in function (Continued)

◆ Full Break-in operation

During Full Break-in operation, the transceiver transmits when you key down, then immediately returns to receive when you release.

- ① On the Mode selection screen, select the CW or CW-R mode. (p. 3-17)
- ② Push **[MENU]**(C) one or more times to select the "M-3" screen (M-3 menu).
- ③ Touch **[BK-IN]**(D) one or more times to turn ON the Full Break-in function.
  - "F-BKIN" appears.

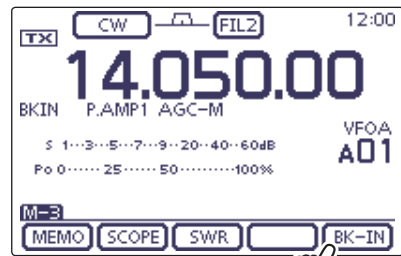

Touch [BK-IN]

Full Break-in icon

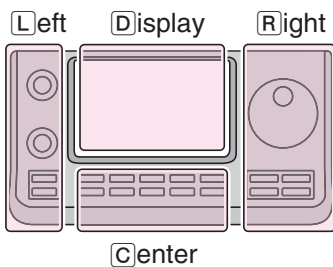
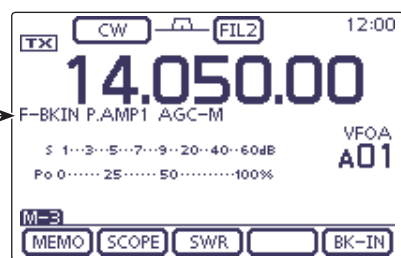

The L, R, C or D in the instructions indicate the part of the controller.  
 L: Left side  
 R: Right side  
 C: Center bottom  
 D: Display (Touch screen)

When using a paddle:

Adjust the keying speed while operating a paddle.

- ① Push **[SPEED/PITCH]**(C) to open the Key speed/CW pitch adjustment window.
- ② Rotate **[M-CH]**(L) to adjust the Key speed.
  - The adjustable key speed is between 6 and 48 wpm (words per minute).
- ③ Push **[MENU]**(C) to close the window.

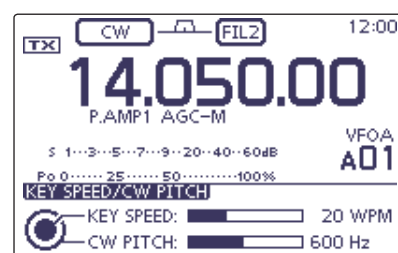
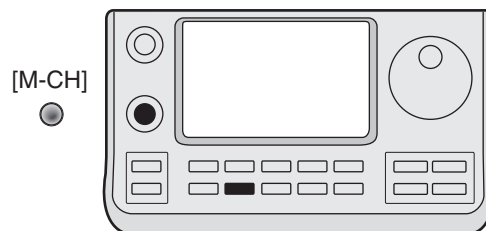

## Speech compressor function

**(Mode: SSB)**

The Speech Compressor function increases average RF output power, improving signal strength and readability.

- ① Select the desired frequency band. (p. 3-6)
- ② On the Mode selection screen, select the USB or LSB mode. (p. 3-17)
- ③ Before first tuning ON the Speech compressor, adjust the microphone gain so that the **ALC** meter reading stays within the ALC zone.

- ① Push **[MIC/RF PWR]**(C) to open the MIC gain/RF power adjustment display.

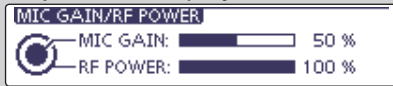

- ② Rotate **[M-CH]**(L) to adjust the MIC gain.
  - To adjust the MIC gain, touch the TX meter to select the ALC meter.
- ③ Push **[MENU]**(C) to close the display.

- ④ Push **[MENU]**(C) one or more times to select the “M-2” screen (M-2 menu).
- ⑤ Touch **[COMP]**(D) to turn ON the Speech Compressor.
  - “COMP” appears.
- ⑥ Touch **[COMP]**(D) for 1 second to display the “COMP” (Compressor) screen.
- ⑦ While speaking into the microphone at your normal voice level, rotate the Dial so that the COMP meter reading stays within the COMP level zone (10 dB to 20 dB zone).
  - To adjust the COMP level, touch the TX meter to select the COMP meter.
  - If desired, touch **[DEF]** for 1 second to reset to the default setting.
- ⑧ Push **[MENU]**(C) to exit the “COMP” screen.

When the COMP meter peaks above the COMP level zone, your transmitted voice may be distorted.

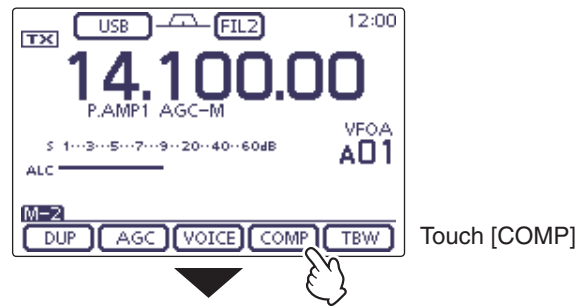
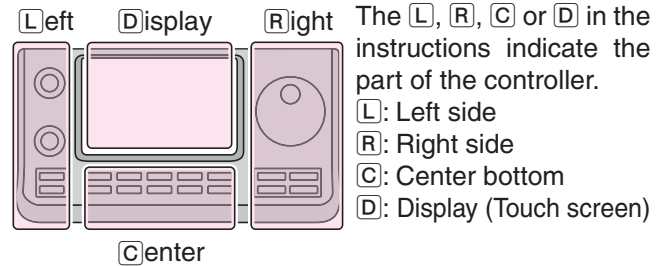

Speech Compressor icon

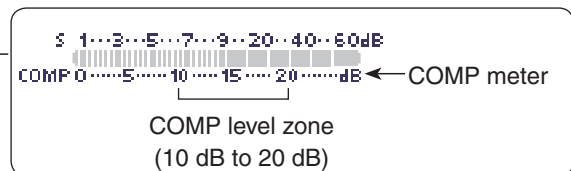
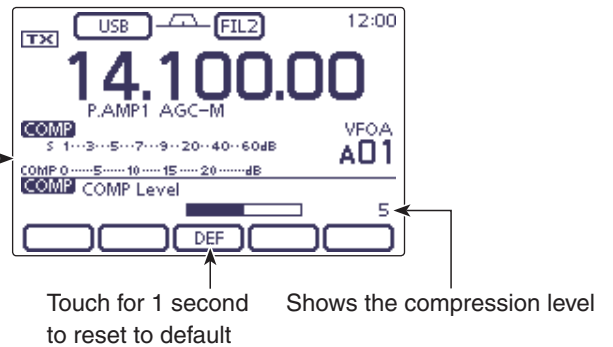
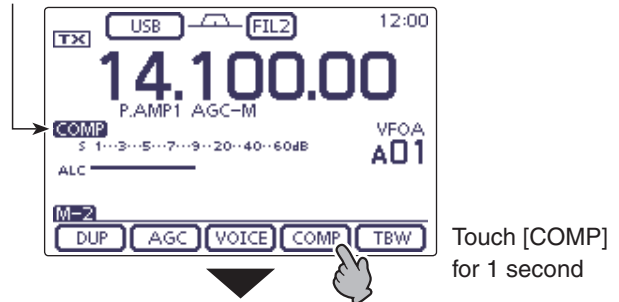

## Transmit filter width selection

**(Mode: SSB)**

The transmit **filter** width for the SSB mode can be selected from Wide, Mid or Narrow. This setting can be memorized each for the Speech Compressor ON and OFF.

- ① Select the desired frequency band. (p. 3-6)
- ② On the Mode selection screen, select the USB or LSB mode. (p. 3-17)
- ③ Push **MENU**(C) one or more times to select the "M-2" screen (M-2 menu).
- ④ Touch **[COMP]**(D) to turn ON the Speech Compressor.
  - "COMP" appears.
- ⑤ Touch **[TBW]**(D) for 1 second one or more times a Wide, Mid or Narrow transmission passband width.
  - Touch **[TBW]**(D) to display the selected TX filter width for approximately 1 second.
  - The following filters are specified as the defaults. Each of the filter widths can be set in the "TBW" items of the "Tone Control" Set mode. (p. 17-23)

**SET**(C) > Tone Control > TX > SSB  
 > **TBW (WIDE), TBW (MID), TBW (NAR)**

- WIDE: 100 Hz to 2900 Hz
- MID: 300 Hz to 2700 Hz
- NAR: 500 Hz to 2500 Hz

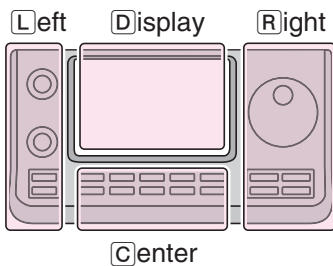

The L, R, C or D in the instructions indicate the part of the controller.

- L: Left side
- R: Right side
- C: Center bottom
- D: Display (Touch screen)

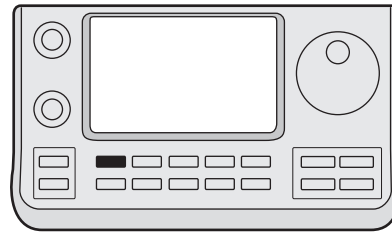

Push **MENU**

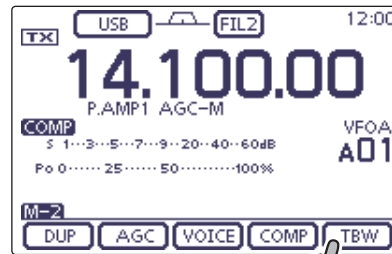

Touch **[TBW]** for 1 second

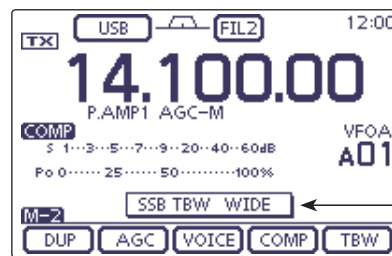

The selected transmit filter width is displayed for approximately 1 second.



## Monitor function

The Monitor function allows you to monitor your transmit IF signals in any mode. Use this to check voice characteristics while adjusting transmit parameters. The CW side tone functions regardless of the “Monitor” setting.

- ① Push **SET**(C) to enter the Set mode.
- ② Touch the “Monitor” item of the “Function” Set mode.
  - Function > **Monitor**
    - If the specified item is not displayed, touch **[▲]** or **[▼]**(D) one or more times to select the page.
- ③ Touch the option to turn ON the function.
- ④ Touch the “Monitor Level” item of the “Function” Set mode.
  - Function > **Monitor Level**
- ⑤ Rotate the Dial to adjust the monitor level.
  - For the clearest audio output, adjust while holding down **[PTT]** and speaking into the microphone.
  - The adjustable monitor level is between 0% (minimum audio level) and 100% (maximum audio level).
  - If desired, touch the level bar for 1 second to open the Default set window, then select “Default” to reset to the default setting.
- ⑥ Push **SET**(C) to exit the Set mode.

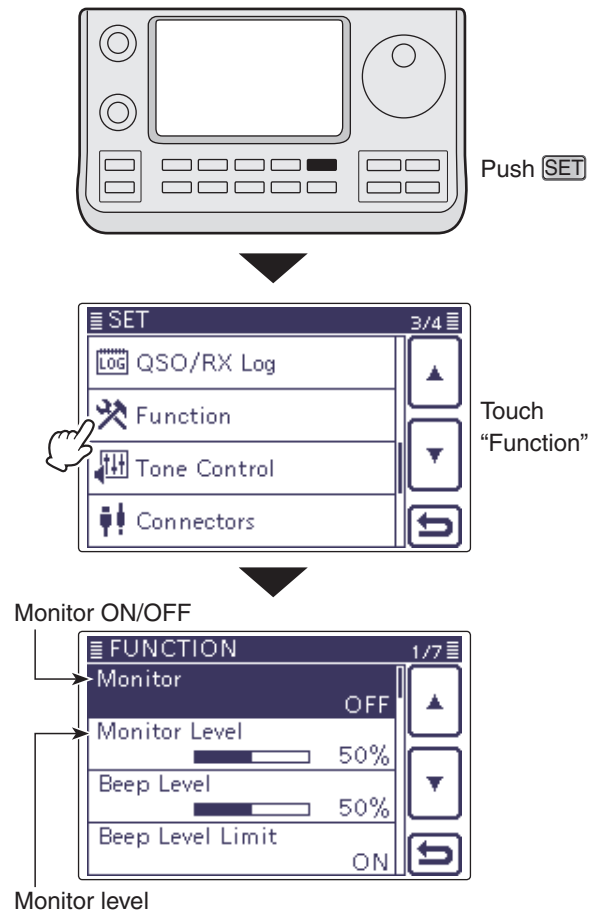

## Split frequency operation

Split frequency operation allows you to transmit and receive on two different frequencies. Split frequency operation is performed using frequencies in VFO A and VFO B.

- The Split frequency operation is automatically turned OFF when turning ON the One-touch repeater function.

The following is an example of setting 21.290 MHz/USB mode for receiving and 21.310 MHz/USB mode for transmitting.

- ① Set 21.290 MHz in VFO A and select the USB mode.
- ② Push **[MENU]**(C) one or more times to select the “M-1” screen (M-1 menu).
- ③ Touch **[SPLIT]**(D) to turn ON the Split function.
  - The transmit frequency (VFO B) and “SPLIT” appear.
  - If desired, tap **[SPLIT]**(D) again to turn OFF the function.
- ④ Set 21.310 MHz in VFO B and select the USB mode. The setting method has the three following ways.
  - (1) While holding down **[XFC]**(R) in VFO A, rotate the Dial to set the transmit frequency to 21.310 MHz in VFO B, and then select the operating mode to USB.
    - While holding down **[XFC]**(R), you can change the frequency band and operating mode in VFO B.
    - While holding down **[XFC]**(R), the transceiver receives the transmit frequency in VFO B.
  - (2) Touch **[A/B]**(D) to select VFO B, rotate the Dial to set the transmit frequency to 21.310 MHz, and then select the operating mode to USB.
  - (3) Use the Quick Split function.
    - The Quick Split function is much more convenient for selecting the transmit frequency. See the next content for details.
- ⑤ Now you can receive on 21.290 MHz and transmit on 21.310 MHz.

To change the transmit and receive frequencies, push **[A/B]** to exchange VFO A and VFO B.

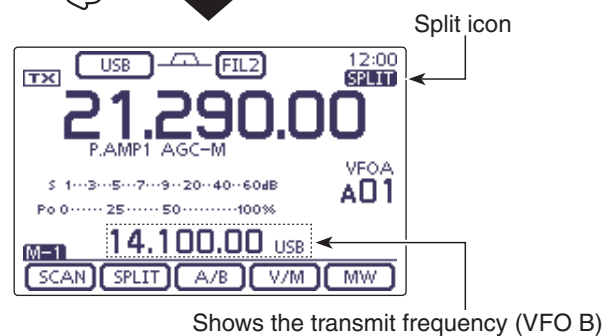
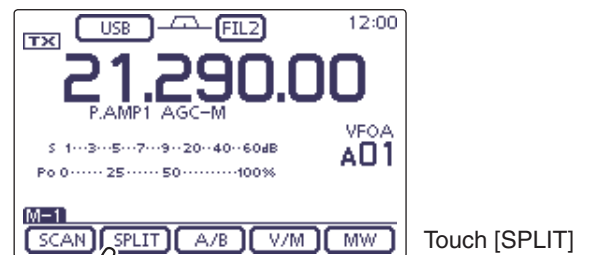
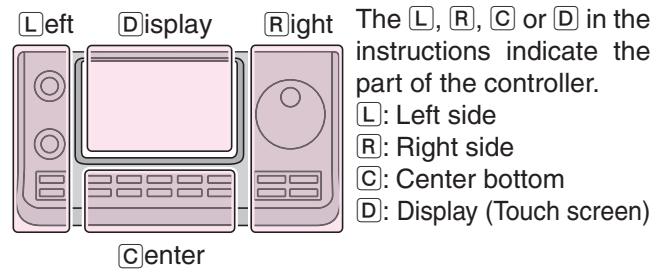

- While holding down **[XFC]** Shows the transmit frequency (VFO B)

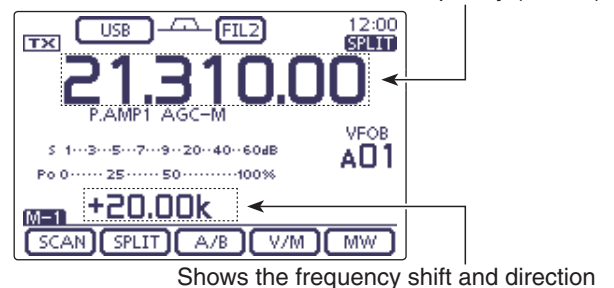

- After setting up

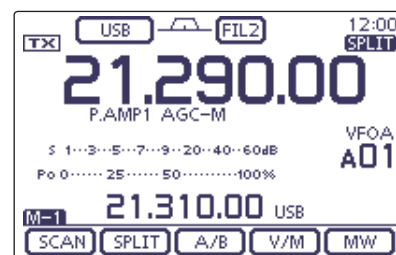

Split frequency operation (Continued)

◆ Direct frequency shift input

The frequency shift can directly be entered.

- ① Touch the MHz digits to enter the Band selection display.
- ② Touch [F-INP](D) to enter the Direct input screen.
- ③ If the Shift direction is minus, touch “• (-).”
  - [SPLIT] changes to [-SPLIT], and displays the Minus setting mode.
- ④ Touch the desired number to enter the desired frequency shift.
  - -9.999 to +9.999 MHz can be set in 1 kHz steps.
- ⑤ Touch [SPLIT] or [-SPLIT](D) to input the frequency shift to the transmit frequency, and the Split function is turned ON.

[Example]

**To transmit on a 10 kHz higher frequency:**

➔ Touch [1], [0] then [SPLIT].

**To transmit on 1.025 MHz lower frequency:**

➔ Touch [• (-)], [1], [0], [2], [5] then [-SPLIT].

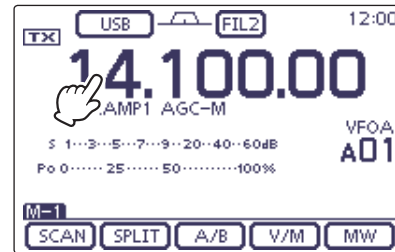

Touch the MHz digits.

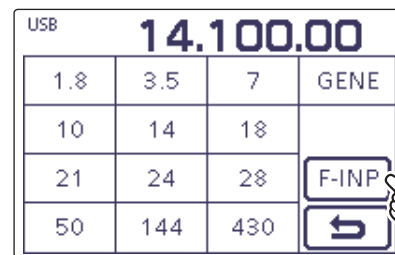

Touch [F-INP]

• Direct input screen

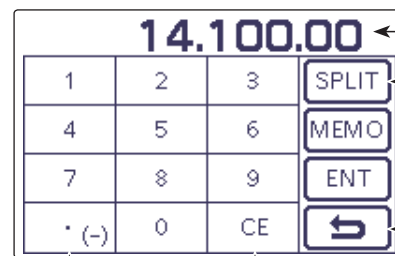

Shows the input digits

Enter the Split off-set

Cancel edit

Minus (-) input

Delete entering

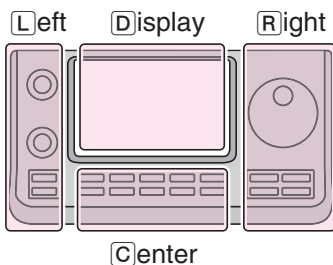

The L, R, C or D in the instructions indicate the part of the controller.

- L: Left side
- R: Right side
- C: Center bottom
- D: Display (Touch screen)

Split frequency operation (Continued)

◆ Split Lock function

The Split Lock function is convenient for changing only the transmit frequency. When the Split Lock function is not used, accidentally releasing **XFC**(R) while rotating the Dial, changes the receive frequency. The Split Lock function is OFF by default, but can be turned ON in the “SPLIT LOCK” item of the “Function” Set mode. (p. 17-19)

• Setting

- ① Push **SET**(C) to enter the Set mode.
- ② Touch the “SPLIT LOCK” item of the “Function” Set mode.
  - Function > SPLIT/DUP > **SPLIT LOCK**
  - If the specified item is not displayed, touch **[▲]** or **[▼]**(D) one or more times to select the page.
- ③ Touch the option to turn ON the function.
- ④ Push **SET**(C) to exit the Set mode.

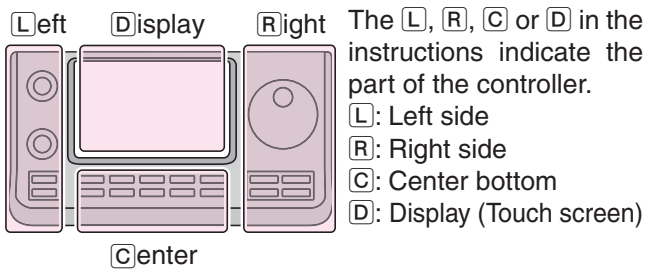

While transmitting with both Split and Split Lock functions ON, rotating the Dial will not change the frequency.

• Operation

- ① While Split frequency operation is ON, hold down **SPEECH**(R) for 1 second to activate the split lock function.
  - “**LO**” appears.
- ② While holding down **XFC**(R), rotate the Dial to change the transmit frequency.
  - If you accidentally release **XFC**(R) while rotating the Dial, the receive frequency does NOT change.

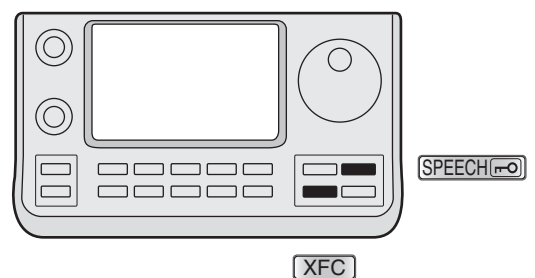
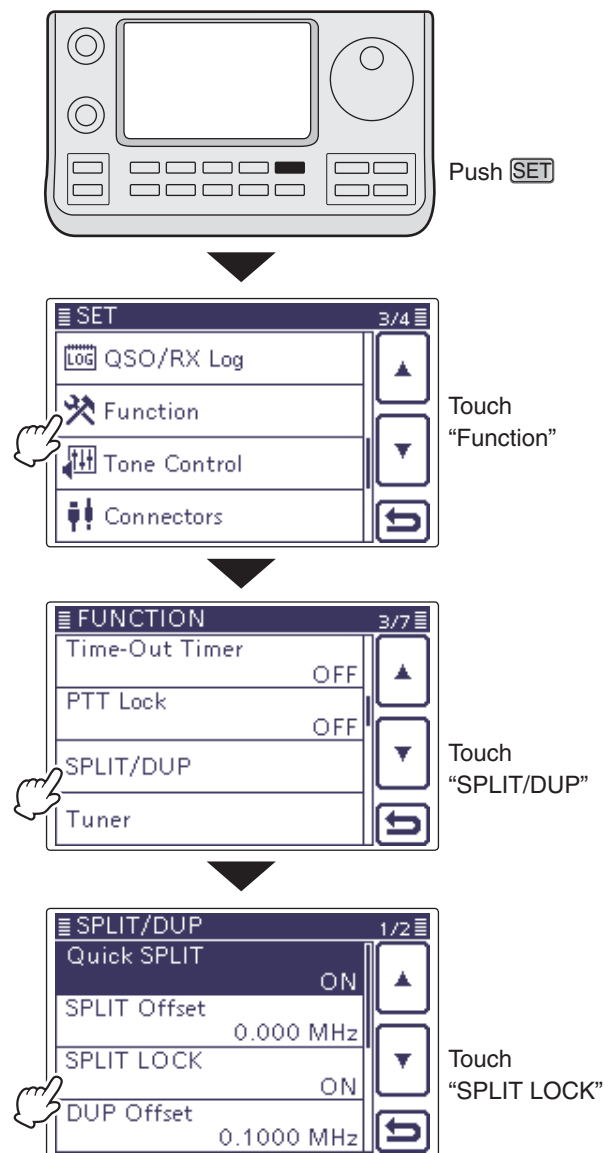

## Quick Split function

When you touch [SPLIT](D) for 1 second, the Split frequency operation is turned ON. The undisplayed VFO is automatically changed according to the plus/minus frequency shift programmed in the "SPLIT Offset" item of the "Function" Set mode (p. 17-19). Or the VFOs are equalized when 0.000 MHz (default setting) is programmed as the Split Offset (p. 17-19).

SET(C) > Function > SPLIT/DUP > **SPLIT Offset**

The Quick Split function is ON by default. For your convenience, it can be turned OFF in the "Quick SPLIT" item of the "Function" Set mode (p. 17-19). In this case, touch [SPLIT](D) for 1 second does not equalize the VFO A and VFO B frequencies.

SET(C) > Function > SPLIT/DUP > **Quick SPLIT**

- ① Suppose you are operating at 21.290 MHz (USB) in VFO A.
- ② Push MENU(C) one or more times to select the "M-1" screen (M-1 menu).
- ③ Touch [SPLIT](D) for 1 second.
  - Split frequency operation is turned ON.
  - The transmit (VFO B) frequency is equalized to the receive (VFO A) frequency.
- ④ While holding down XFC(R), rotate the Dial to set the frequency offset between transmit and receive.
  - When XFC(R) is released, the receive frequency is displayed.

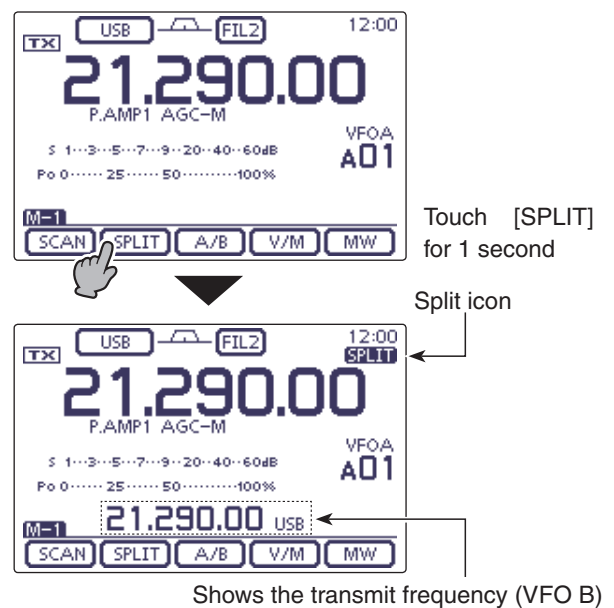
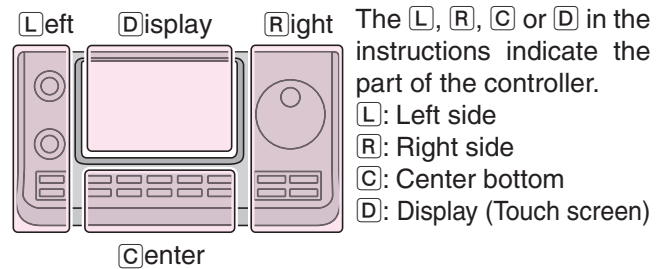

- While holding down XFC Shows the transmit frequency (VFO B)

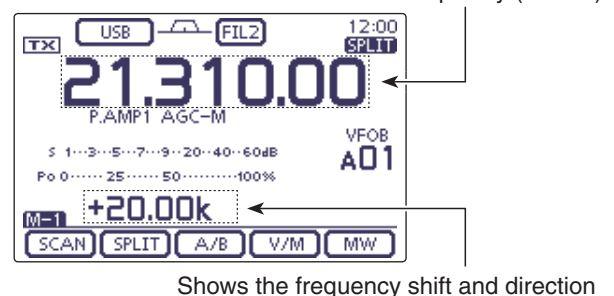

The example shows the split offset is set to +20 kHz (+0.020 MHz).

Quick Split function (Continued)

◆ Split frequency offset setting

By setting an often-used split frequency offset in advance, you can use the Quick Split function to select split operation at the touch of one key.

- ① Push **SET**(C) to enter the Set mode.
- ② Touch the "SPLIT Offset" item of the "Function" Set mode.  
 Function > SPLIT/DUP > **SPLIT Offset**
  - If the specified item is not displayed, touch **▲** or **▼**(D) one or more times to select the page.
- ③ Touch the number to enter the desired frequency shift, and then touch **[ENT]**(D).
- -9.999 to +9.999 MHz can be set in 1 kHz steps.
- ④ Push **SET**(C) to exit the Set mode.

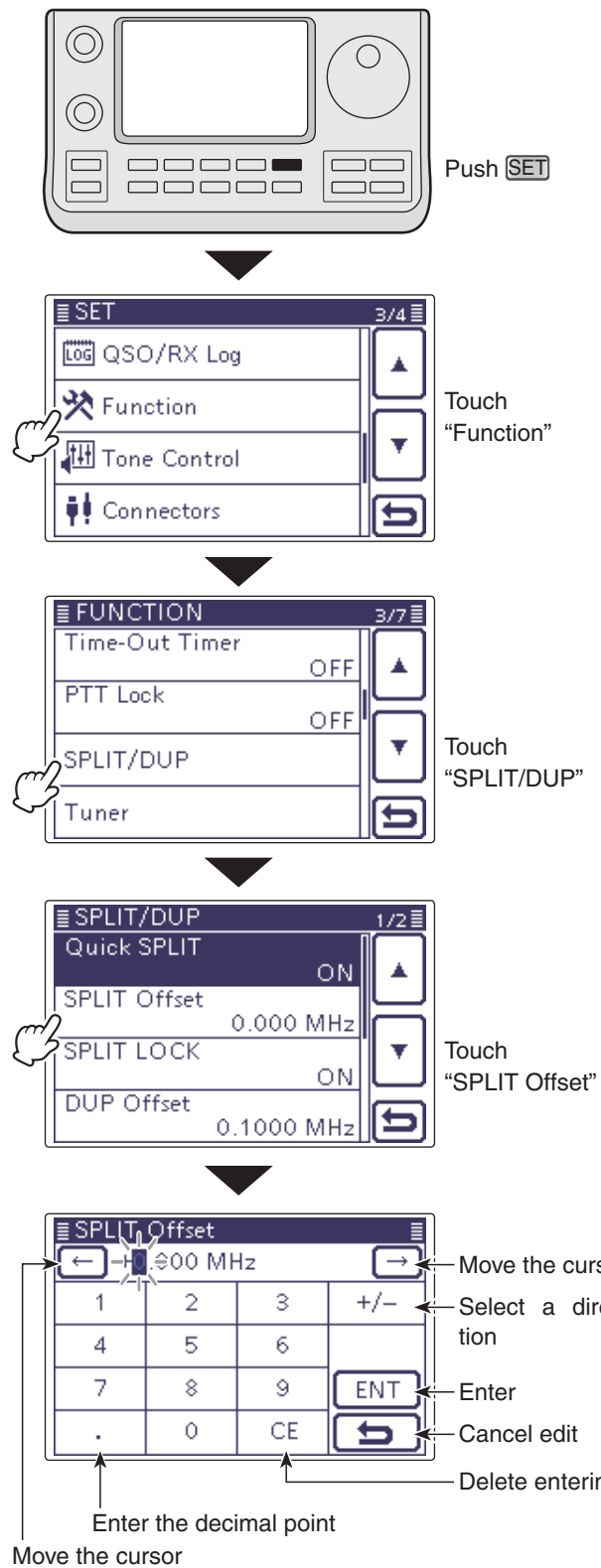
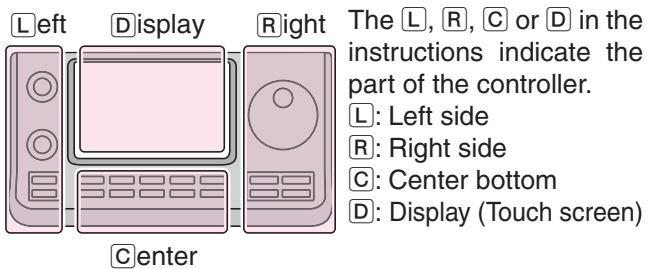

## Measuring SWR

The IC-7100 has a built-in circuit for measuring antenna SWR— no external equipment or special adjustments are necessary.

The IC-7100 can measure SWR two ways — spot measurement and plot measurement.

### ◆ Spot measurement

This function is convenient to use when measuring SWR of the antenna to install or periodic check.

- ① If desired, push **[TUNER/CALL]**(L) once or twice to turn OFF the **antenna tuner**.
  - If the antenna tuner is connected, and your want to measure SWR of the antenna itself, perform this step.
- ② Select the desired frequency band. (p. 3-6)
- ③ On the Mode selection screen, select the RTTY or RTTY-R mode. (p. 3-17)
- ④ If necessary, adjust the RF power to more than 30 W on the Mic gain/RF power adjustment display.
  - If your are operating in the 144 MHz band, adjust the RF power to more than 20 W.
  - If your are operating in the 430 MHz band, adjust the RF power to more than 15 W.
  - If your are operating in the 70 MHz band, adjust the RF power to more than 20 W. (70 MHz band transmission is available, depending on the transceiver version.)

- ① Push **[MIC/RF PWR]**(C) to open the MIC gain/RF power adjustment display.

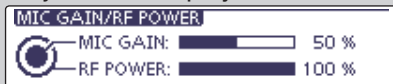

- ② Rotate **[BANK]**(L) to adjust the RF power.
- ③ Push **[MENU]**(C) to close the display.

Before transmitting, monitor the operating frequency to make sure transmitting won't cause interference to other stations on the same frequency.

- ⑤ Touch the TX meter one or more times to select the SWR meter.
- ⑥ Hold down **[PTT]** on the microphone or switch ON the external TX switch to transmit.
- ⑦ Read the SWR on the SWR meter.
  - If the SWR meter points 1.5 or less, the antenna is matched .
- ⑧ Release **[PTT]** or Switch OFF the external TX switch to receive.
  - When the measured SWR is more than 1.5:1, adjust the antenna to match with the transceiver.

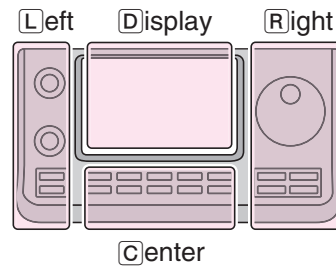

The L, R, C or D in the instructions indicate the part of the controller.

- L: Left side
- R: Right side
- C: Center bottom
- D: Display (Touch screen)

### NOTE

This transceiver can measure SWR in the 144 MHz or 430 MHz bands. Depending on the length of the connected coaxial cable, or installation condition, the measurement may be different from the actual SWR of the antenna in these band.

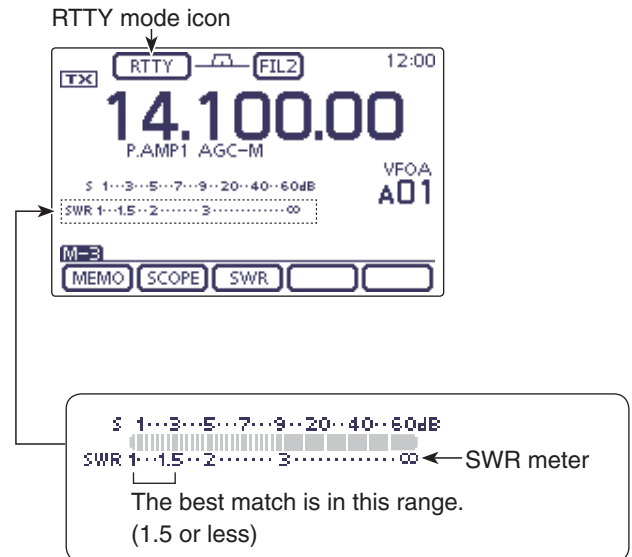

Measuring SWR (Continued)

◆ Plot measurement

Plot measurement allows you to measure the SWR over an entire band.

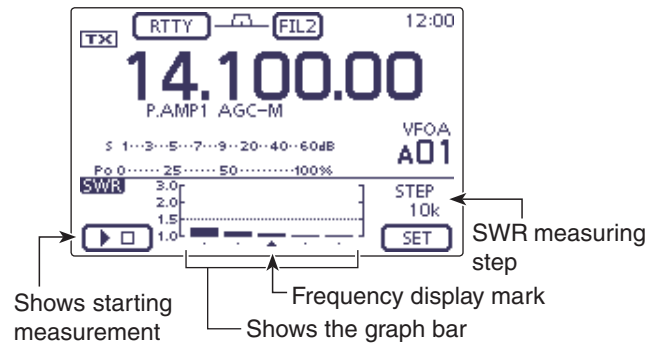

INDICATOR	DESCRIPTION
<b>Measurement start icon</b>	Touch [▶■](D) to start the measuring. While measuring, “▶□” is displayed. The measured frequency is displayed by the frequency display mark, “▲,” below the graph bar. While measuring SWR, the frequency cannot be changed. When quieting the SWR measurement, the frequency returns to the previous frequency before starting the SWR measurement.
<b>Graph bar display</b>	Each vertical dot indicates the SWR value, and horizontal bar indicates the number of measurement steps. The measurement steps can be selected the “Number of Graph Bar” item of the “SWR GRAPH SET” screen. SWR graph displays SWR 1 to 3 vertically, and many dots indicates the worse SWR. (SWR is displayed 1.0=1 dot, 1.5=10 dots, 2.0=19 dots and 3.0=28 dots.)
<b>Frequency display mark</b>	Displays the relative position of the measurement frequency.
<b>SWR measuring step</b>	Displays the selected SWR measuring step. Set the “Measuring Step” item of the “SWR GRAPH SET” screen.

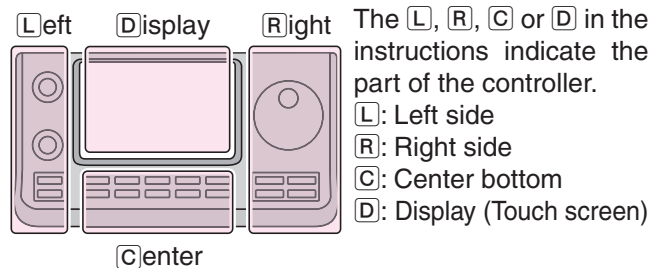



**Measuring SWR**

◇ Plot measurement (Continued)

- ① Select the desired frequency band. (p. 3-6)
- ② On the Mode selection screen, select the RTTY or RTTY-R mode. (p. 3-17)
- ③ If necessary, adjust the RF power to more than 30 W on the Mic gain/RF power adjustment display.
  - If your are operating in the 144 MHz band, adjust the RF power to more than 20 W.
  - If your are operating in the 430 MHz band, adjust the RF power to more than 15 W.
  - If your are operating in the 70 MHz band, adjust the RF power to more than 20 W. (70 MHz band transmission is available, depending on the transceiver version.)

① Push [MIC/RF PWR](C) to open the MIC gain/RF power adjustment display.

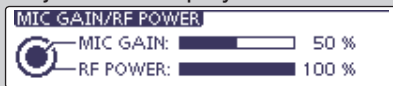

② Rotate [BANK]Ⓞ(L) to adjust the RF power.

Before transmitting, monitor the operating frequency to make sure transmitting won't cause interference to other stations on the same frequency.

- ④ Push [MENU](C) one or more times to select the "M-3" screen (M-3 menu).
- ⑤ Touch [SWR](D) to display the "SWR" (SWR Graph) screen.
- ⑥ Set the center frequency for the SWR to be measured.
- ⑦ If necessary, touch [SET](D) to enter the "SWR GRAPH SET" screen to set the Number of graph bar or Measuring step.
  - The selectable number of graph bar are 3, 5, 7, 9, 11 and 13.
  - The selectable measuring steps are 10k, 50k, 100k and 500 kHz.
  - Touch [↵](D) or push [MENU](C) to return to the previous screen.
- ⑧ Touch [▶□](D) to start the measuring.
  - A frequency marker, "▲," appears below the left edge of the graph bars and displays the frequency.
- ⑨ Hold down [PTT] on the microphone or switch ON the external TX switch to transmit.
  - The bar graph displays the SWR.
- ⑩ Release [PTT] or Switch OFF the external TX switch to receive.
  - The frequency marker moves to, and frequency display changes to the next frequency to be measured.
- ⑪ Repeat steps ⑨ and ⑩ to measure SWR over the entire frequency range.

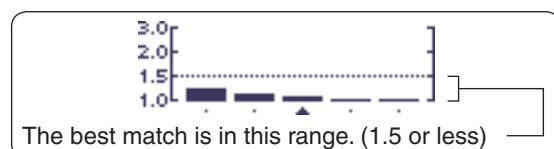
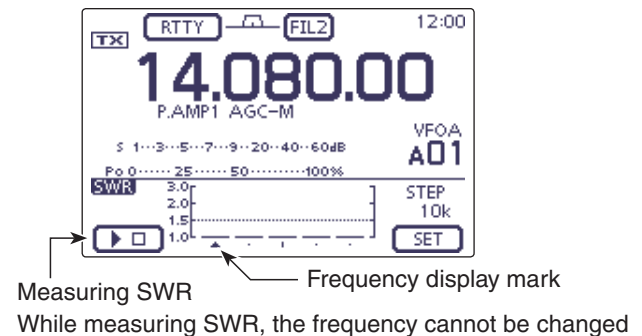
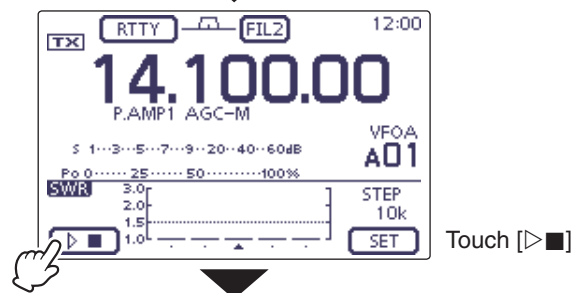
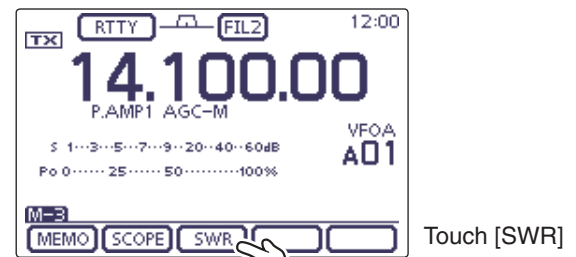
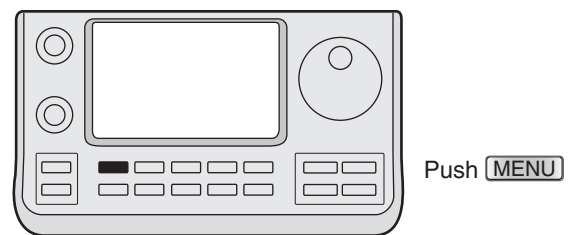
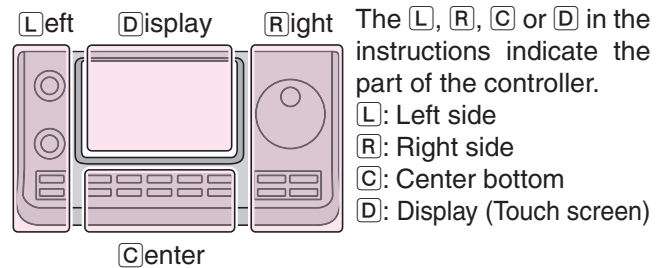

**Measuring SWR (Continued)**

**◇ SWR Graph Set mode**

- ① Push **MENU**(C) one or more times to select the “M-3” screen (M-3 menu).
- ② Touch **[SWR]**(D) to display the “SWR” (SWR Graph) screen.
- ③ Touch **[SET]**(D) to enter the “SWR GRAPH SET” screen.
- ④ Touch the desired item to select.
  - See below for details of the set items and options.
- ⑤ Touch the desired option to change the setting.
  - If desired, touch the item for 1 second to open the Default set window, then select the “Default” to reset to the default setting.
- ⑥ Touch **[↶]**(D) or push **MENU**(C) to return to the “SWR” (SWR Graph) screen.
- ⑦ Push **MENU**(C) to return to the “M-3” screen (Menu 3).

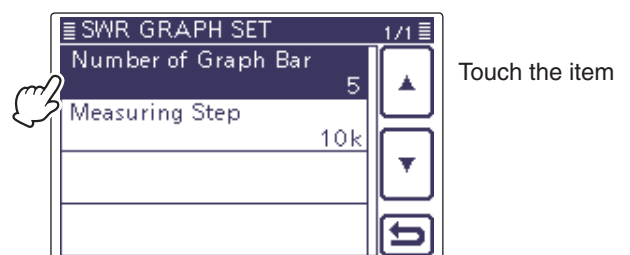
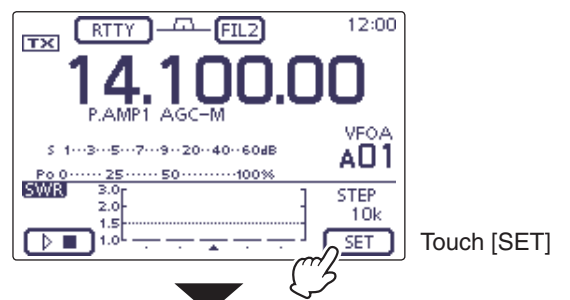
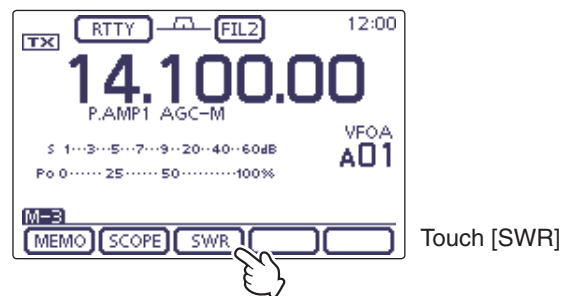
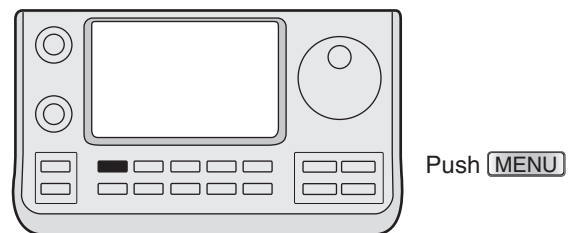
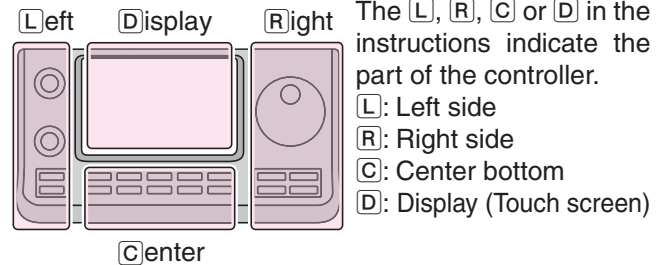

**Number of Graph Bar (Default: 5)**

Select the number of the graph bar for the displayed SWR Graph.

- The selectable number are 3, 5, 7, 9, 11 and 13.

**Measuring Step (Default: 10k)**

Select the SWR measuring step for the center frequency.

- The selectable steps are 10k, 50k, 100k and 500 kHz.

## DTMF Memory encoder

**DTMF** tones are used for autopatching, controlling other equipment, and so on. The transceiver has 16 DTMF memory channels for storage of often-used DTMF codes sequence of up to 24 digits.

### ◇ Programming a DTMF code

- ① Select the desired frequency band. (p. 3-6)
- ② On the Mode selection screen, select the FM or DV mode. (p. 3-17)
  - The DTMF encoder can be used in the FM or DV mode.
- ③ Push **MENU**(C) one or more times to select the “M-3” screen (M-3 menu).
  - If you are operating in the DR mode, push **MENU**(C) once or twice to select the “D-2” screen (D-2 menu).
- ④ Touch **[DTMF]**(D) to display the DTMF mode.
  - The “DTMF” screen is displayed.
- ⑤ Touch **[EDIT]**(D) to display the “DTMF MEMORY” screen.
- ⑥ Touch the desired channel to select.
  - “d0” to “d9,” “dA” to “dD,” “d\*” and “d#” are selectable.
- ⑦ Touch the number or character to enter the desired DTMF code.
- ⑧ After entering the DTMF codes, touch **[ENT]**(D) to save the channel, and return to the “DTMF MEMORY” screen.
- ⑨ Touch **[↶]**(D) or push **MENU**(C) to return to the “DTMF” screen.

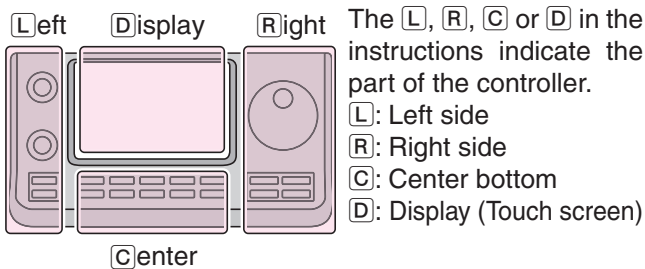
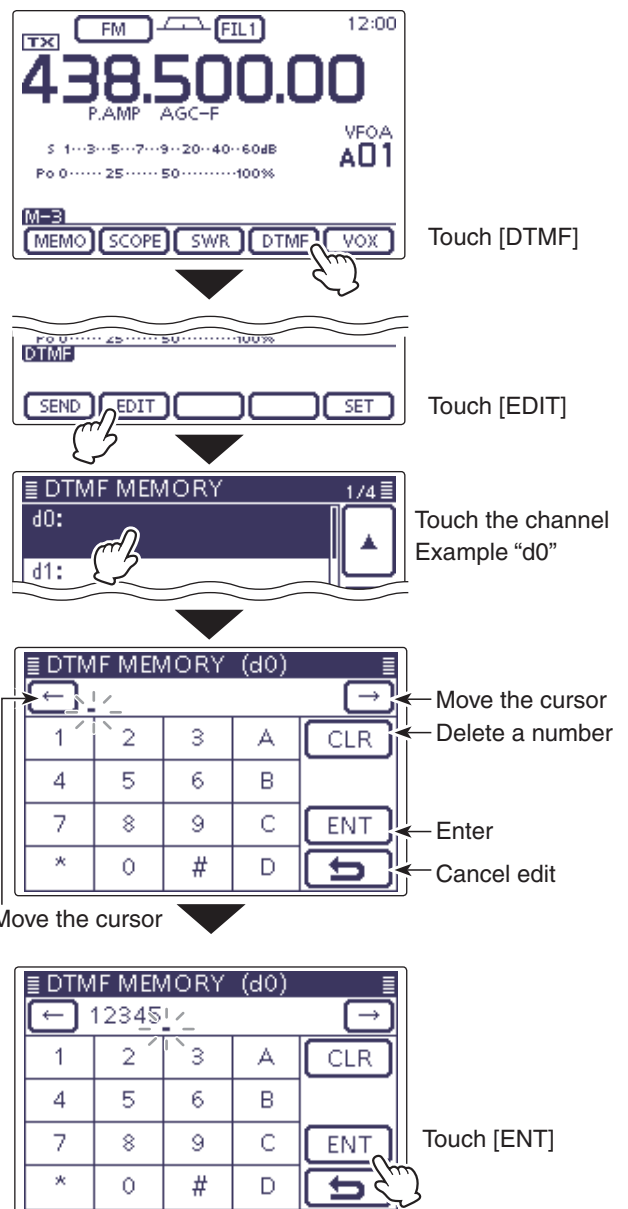

DTMF memory encoder (Continued)

◆ **Transmitting DTMF code**

To transmit **DTMF** code using a DTMF send window, program the desired code in advance.

- ① Select the desired frequency band. (p. 3-6)
- ② On the Mode selection screen, select the FM or DV mode. (p. 3-17)
  - The DTMF encoder can be used in the FM or DV mode.
- ③ Push **MENU**(C) one or more times to select the “M-3” screen (M-3 menu).
  - If your are operating in the DR mode, push **MENU**(C) once or twice to select the “D-2” screen (D-2 menu).
- ④ Touch **[DTMF]**(D) to display the DTMF mode.
  - The “DTMF” screen is displayed.
- ⑤ Touch **[SEND]**(D) to open the DTMF send window.
- ⑥ Touch the desired channel to transmit the DTMF code.
  - The transceiver automatically transmits the selected DTMF code.
  - While transmitting, touch **[SEND]**, **[EDIT]** or **[SET]**(D) or push **MENU**(C), **SET**(C) or **XFC**(R), cancels the transmission.
  - After transmitting, transceiver returns to the “DTMF” screen.

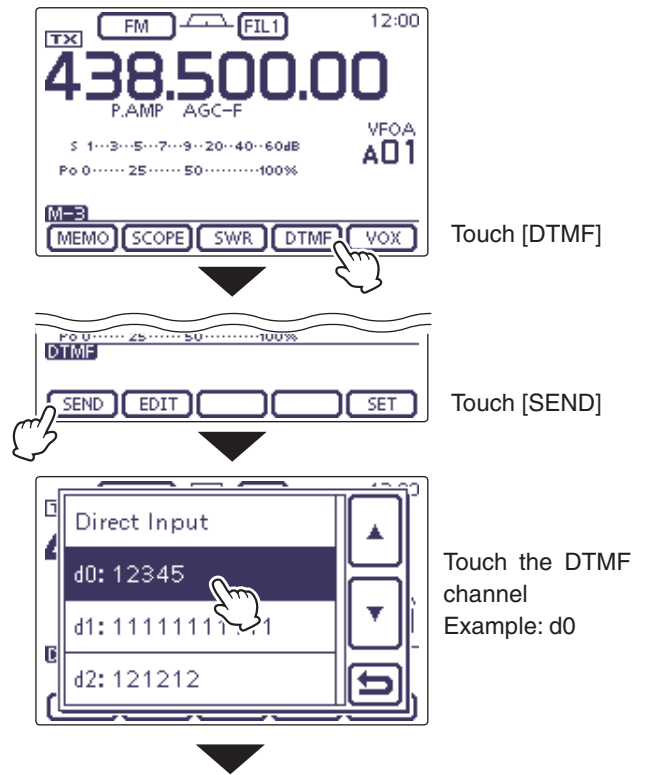

• **While transmitting**

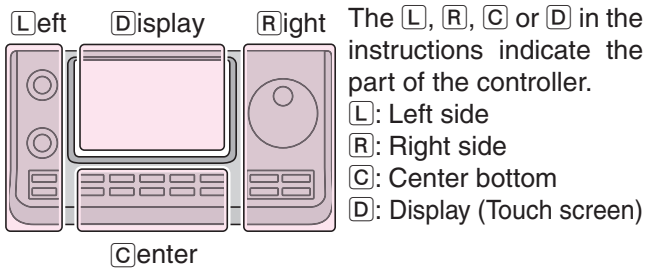
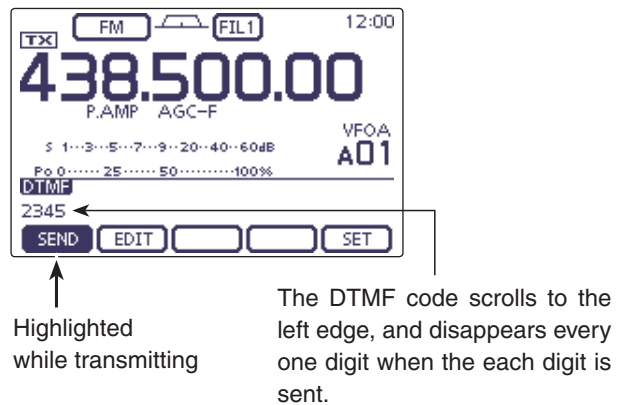

DTMF memory encoder (Continued)

◆ Transmitting DTMF code (Direct Input)

- ① Select the desired frequency band. (p. 3-6)
- ② On the Mode selection screen, select the FM or DV mode. (p. 3-17)
  - The DTMF encoder can be used in the FM or DV mode.
- ③ Push **MENU**(C) one or more times to select the “M-3” screen (M-3 menu).
  - If your are operating in the DR mode, push **MENU**(C) once or twice to select the “D-2” screen (D-2 menu).
- ④ Touch **[DTMF]**(D) to display the DTMF mode.
- ⑤ Touch **[SEND]**(D) to open the DTMF send window.
- ⑥ Touch “Direct Input” to display the “DTMF DIRECT INPUT” screen.
- ⑦ Touch the number or character to enter the desired DTMF code.
- ⑧ When all digit are set, touch **[TX]**(D) to transmit the code.
  - The transceiver automatically transmits the DTMF code.
  - While transmitting, touch **[SEND]**, **[EDIT]** or **[SET]**(D) or push **MENU**(C), **SET**(C) or **XFC**(R), cancels the transmission.
  - After transmitting, transceiver returns to the “DTMF” screen.

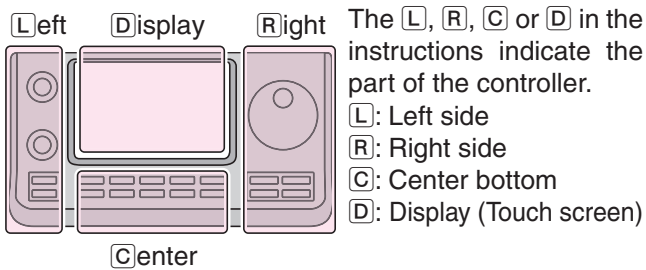
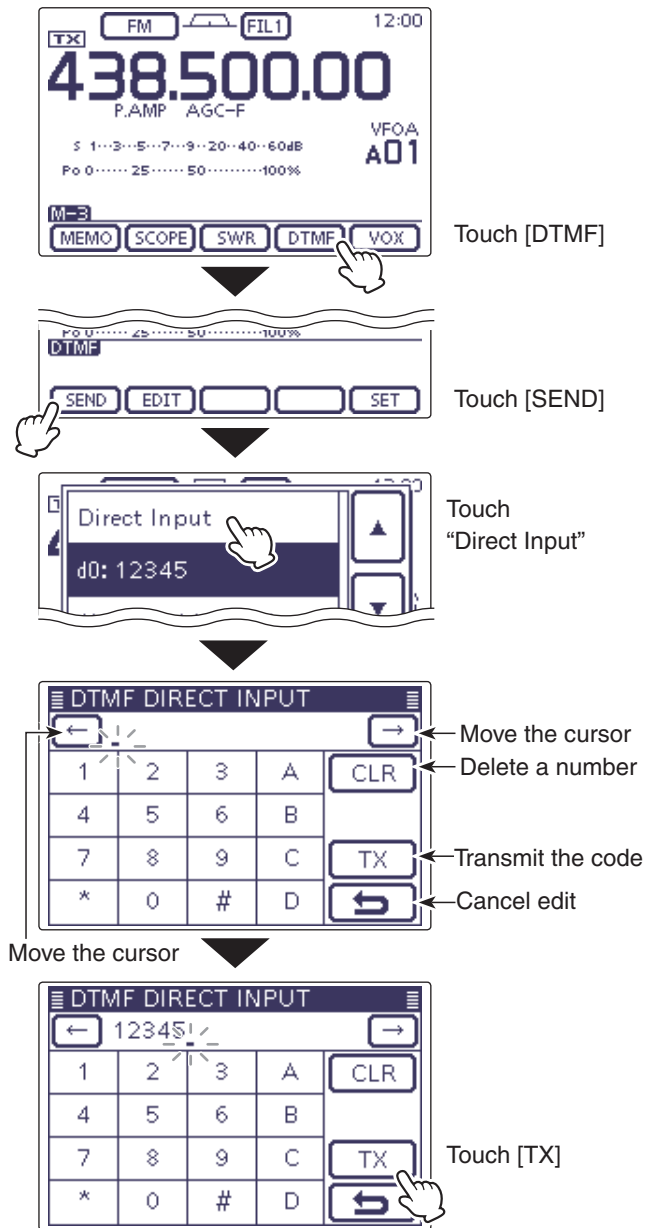

• While transmitting

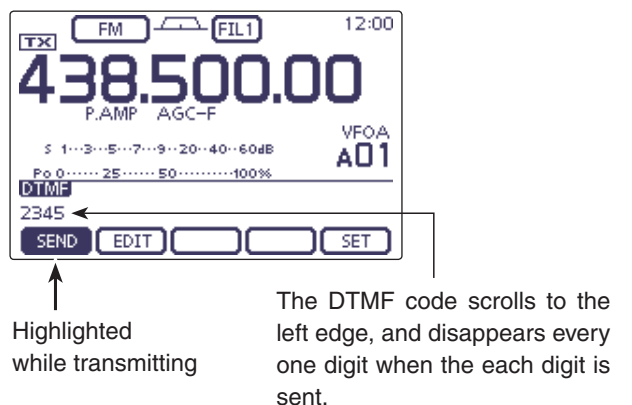

**DTMF memory encoder (Continued)**

◆ **Setting DTMF transfer speed**

The DTMF transfer speed can be selected.

- ① On the Mode selection screen, select the FM or DV mode. (p. 3-17)
  - The DTMF encoder can be used in the FM or DV mode.
- ② Push **MENU**(C) one or more times to select the “M-3” screen (M-3 menu).
  - If your are operating in the DR mode, push **MENU**(C) once or twice to select the “D-2” screen (D-2 menu).
- ③ Touch **[DTMF]**(D) to display the DTMF mode.
  - The “DTMF” screen is displayed.
- ④ Touch **[SET]**(D) to enter the “DTMF SET” mode.
- ⑤ Touch “DTMF Speed” to enter the “DTMF Speed” set screen.
- ⑥ Touch the desired option to change the setting.
  - 100ms: Transfer the DTMF tones at about 100 milliseconds per code.  
5 characters per second.
  - 200ms: Transfer the DTMF tones at about 200 milliseconds per code.  
2.5 characters per second.
  - 300ms: Transfer the DTMF tones at about 300 milliseconds per code.  
1.6 characters per second.
  - 500ms: Transfer the DTMF tones at about 500 milliseconds per code.  
1 character per second.
  - If desired, touch the item for 1 second to open the Default set window, then select the “Default” to reset to the default setting.
- ⑦ Touch **[>]**(D) or push **MENU**(C) to return to the “DTMF” screen.

Example: Set the DTMF transfer speed to 300 milliseconds.

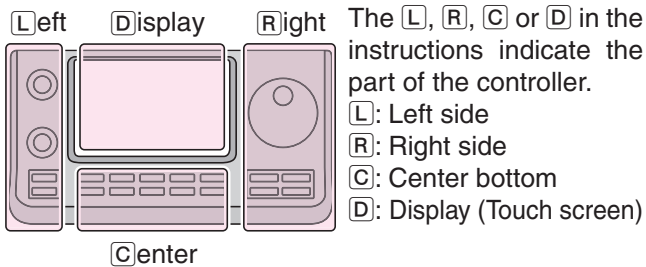
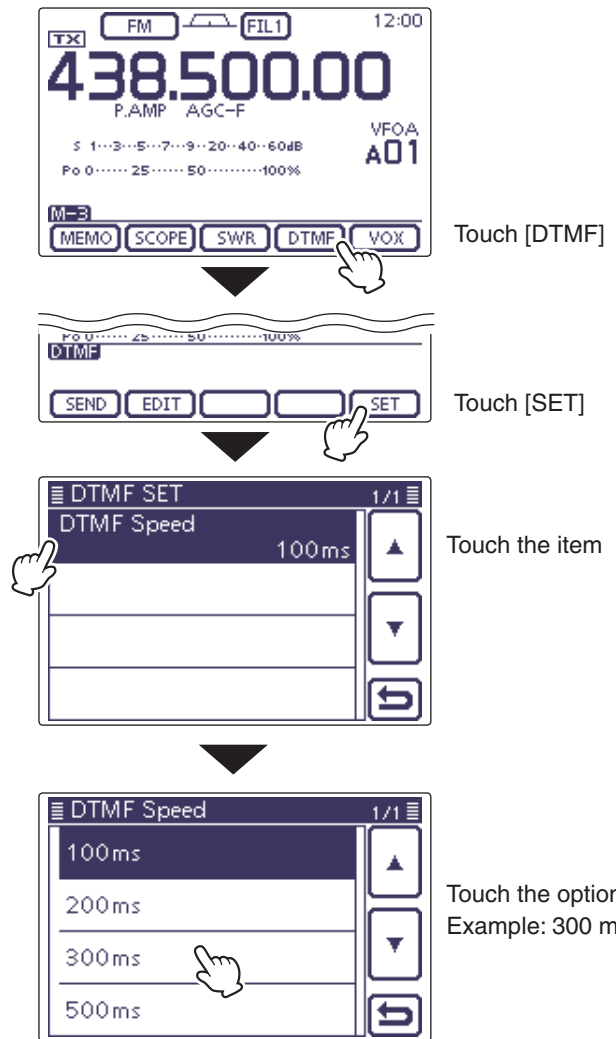

“MY” (Your own call sign) programming .....	7-2
D-STAR Introduction .....	7-5
About the DR (D-STAR Repeater) mode .....	7-6
Communication Form in the DR mode .....	7-7

## **IMPORTANT!**

- The repeater list described in this manual may differ from your transceiver’s preloaded contents.
- Although Japanese repeaters are used in the setting examples, the Japanese repeater node (port) letters are different from those in other countries.

Be sure to add a repeater node letter as the 8th digit in the call sign field after a repeater call sign according to the repeater frequency band shown below.

1200 MHz: A (B in Japan)

430 MHz: B (A in Japan)

144 MHz: C (no D-STAR repeaters in Japan)

## “MY” (Your own call sign) programming

Before starting **D-STAR**, the following steps are needed.

**IMPORTANT!** **STEP 1** Entering your **call sign** (MY) into the transceiver. → **STEP 2** Registering your call sign (MY) to a gateway repeater. → You have completed the steps!!

You can store up to 6 “MY” call signs.

Example: Enter “JA3YUA” as your own call sign into the MY call sign memory [MY1].

### 1. Display the My Call Sign Edit screen

- ① Push **SET**(**C**) to enter the Set mode.
- ② Touch the “MY Call Sign” item of the “My Station” Set mode.  
 My Station > **MY Call Sign**
  - If the specified item is not displayed, touch [**▲**] or [**▼**](**D**) one or more times to select the page.
- ③ Touch the desired call sign memory for 1 second.  
 (Example: 1:)
- ④ Touch the “Edit” item.  
 • The “MY CALL SIGN (MY\*)” screen appears.  
 The memory number, selected in the step ③, is displayed.  
 (Example: MY1)

The **L**, **R**, **C** or **D** in the instructions indicate the part of the controller.

**L**: Left side, **R**: Right side, **C**: Center bottom  
**D**: Display (Touch screen)

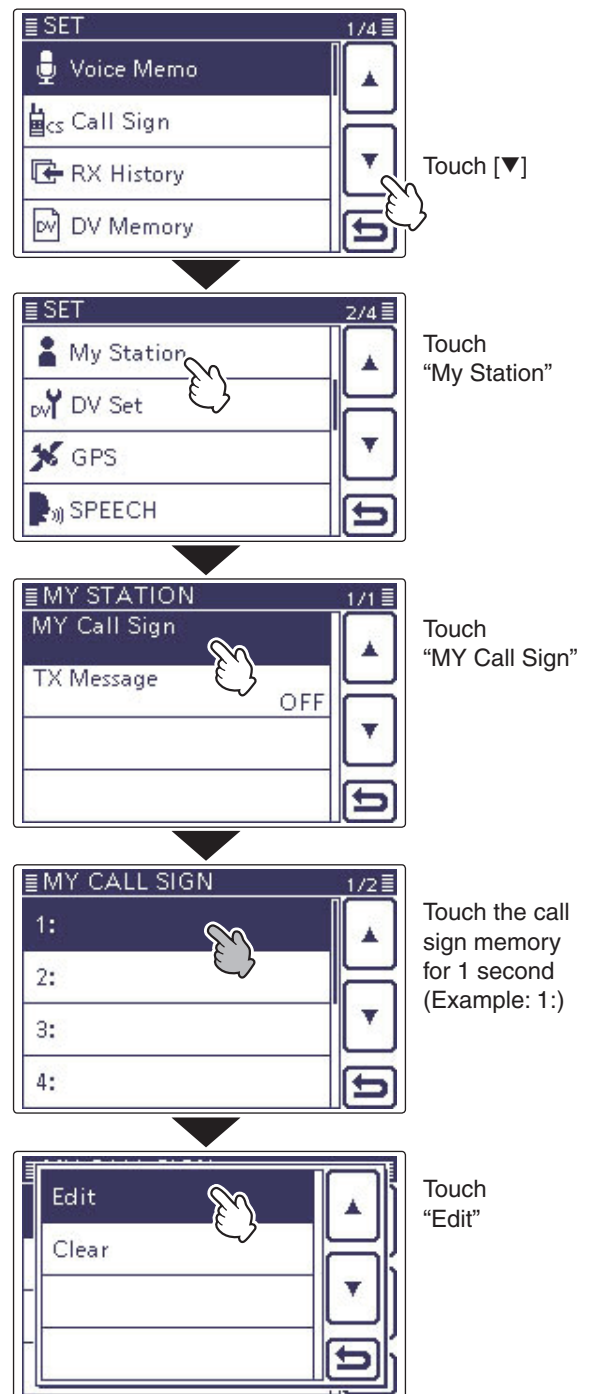

Continued on the next page



**“MY” (Your own call sign) programming (Continued)**

**2. Enter the Call Sign**

- ⑤ Touch the desired block one or more times to select the desired character.
  - (Example: J)
  - A to Z, 0 to 9 and / are selectable.
  - Touch “AB↔12” to toggle between the Alphabet input and the Number input mode.
  - Touch [CLR](D) to delete the selected character, symbol or number.
  - Touch “\_” to input a space.
- ⑥ Touch [←](D) to move the cursor backwards, or touch [→](D) to move the cursor forwards.
- ⑦ Repeat steps ⑤ and ⑥ to enter your own call sign of up to 8 characters, including spaces.
  - (Example: First J, then A, then 3, then Y, then U, then A)
- ⑧ Touch [ENT](D) to return to the “MY CALL SIGN” screen.

**Call sign edit screen**

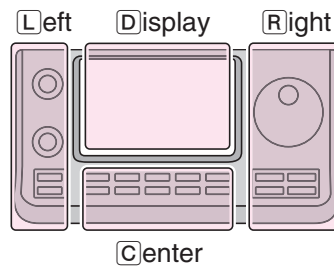
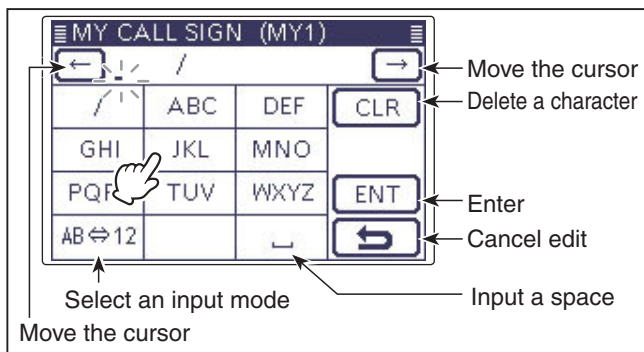

The L, R, C or D in the instructions indicate the part of the controller.

- L: Left side
- R: Right side
- C: Center bottom
- D: Display (Touch screen)

Enter “JA3YUA” into [MY1].

- ① Touch “JKL” to enter ‘J.’
- ② Touch “ABC” to enter ‘A.’
- ③ Touch “AB↔12”.
- Number input mode is selected.
- ④ Touch “3” to enter ‘3.’
- ⑤ Touch “AB↔12”.
- Alphabet input mode is selected.
- ⑥ Touch “WXYZ” three times to enter ‘Y.’
- ⑦ Touch “TUV” two times to enter ‘U.’
- ⑧ Touch “ABC” to enter ‘A.’
- ⑨ Touch [ENT]

Continued on the next page

**“MY” (Your own call sign) programming**

2. Enter the Call Sign (Continued)

- ⑨ Touch the entered call sign to set the call sign to be used.
- ⑩ Push **SET**(C) to exit the Set mode.

**✓ Convenient!**

If necessary, enter a note of up to 4 characters, such as the model of the transceiver, name, area name, and so on, after your **call sign**.

- ① Touch **[→]**(D) one or more times until the cursor moves to the right of the “/”.



- ② Repeat steps ⑤ and ⑥ on the page 7-3 to enter a desired 4 character note.  
(Example: 7100)

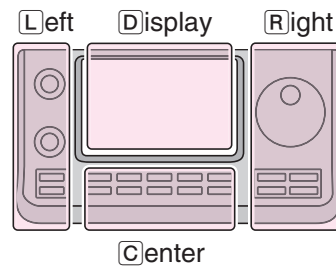
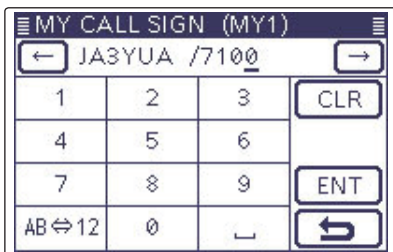

The **L**, **R**, **C** or **D** in the instructions indicate the part of the controller.

- L**: Left side
- R**: Right side
- C**: Center bottom
- D**: Display (Touch screen)

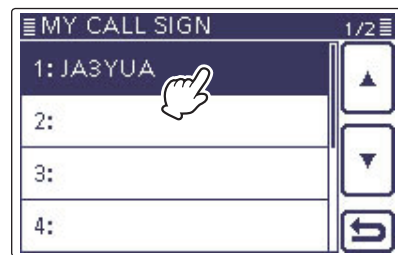

Touch the call sign  
(Example: 1:JA3YUA)

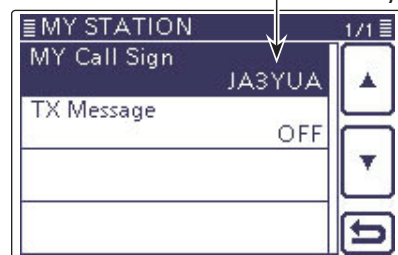

Push **SET**

**✓ Important!**

To use a repeater gateway, you must register your call sign with a gateway repeater, usually one near your home location.

If needed, ask the gateway repeater administrator for call sign registration instructions.

## **D-STAR Introduction**

- In the original D-STAR (Digital Smart Technologies for Amateur Radio) plan, JARL envisioned a system of repeaters grouped together into Zones.
- The D-STAR repeater enables you to call a HAM station on another repeater through the internet.
- The transceiver can be operated in the digital voice mode, including low-speed data operation, for both transmit and receive.

## About the DR (D-STAR Repeater) mode

The DR (D-STAR Repeater) mode is one mode you can use for D-STAR repeater operation. In this mode, you can select a preprogrammed repeater or frequency in "FROM" (the access repeater or simplex), and UR call sign in "TO" (destination), as shown to the right.

**NOTE:** If the repeater, set to "FROM" (Access Repeater) has no Gateway call sign, you cannot make a gateway call.

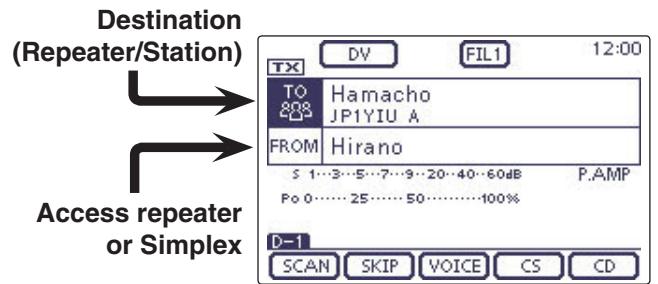

In the DR mode

## Communication Form in the DR mode

In the DR mode, the transceiver has three communication forms, as shown below.

- Local area call: To call through your local area (access) repeater.
- Gateway call: To call through your local area (access) repeater, repeater gateway and the internet to your destination repeater or individual station's last used repeater, using **call sign** routing.
- Simplex call: To call another station not using a repeater.

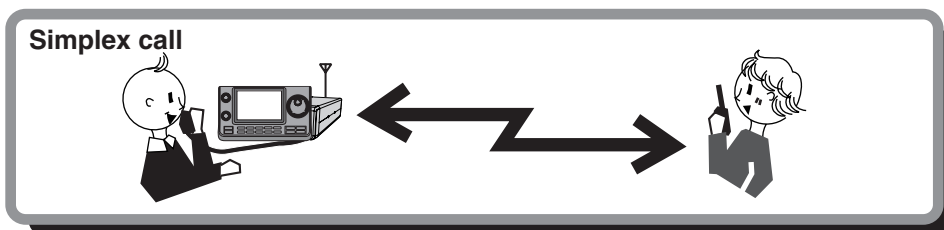
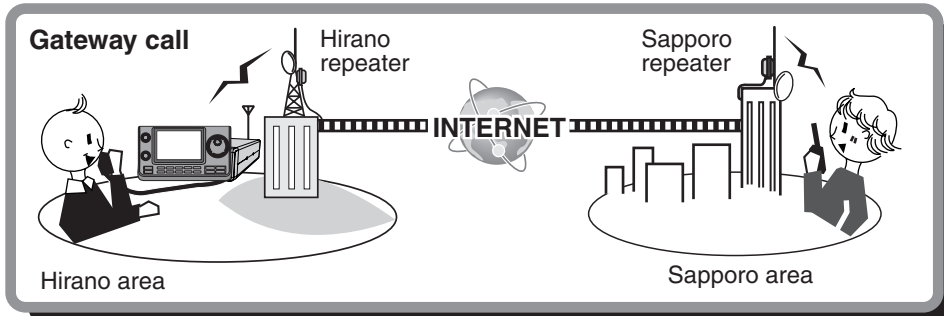
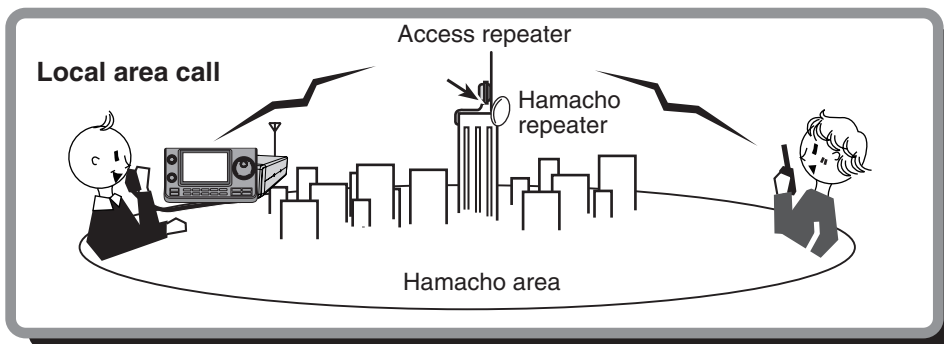

### NOTE:

- Programming the repeater list is required for DR mode operation. (pp. 9-29 to 9-37)
- Before operating in the DV mode, be sure to check whether the access repeater is busy, or not. If the repeater is busy, wait until it is clear, or ask for a "break" using a method acceptable to your local procedures.
- The transceiver has a Time-Out Timer function for digital repeater operation. The timer limits a continuous transmission to approximately 10 minutes. Warning beeps will sound approximately 30 seconds before time-out and then again immediately before time-out.

<b>D-STAR Operating procedures</b> .....	<b>8-2</b>
◇ Making a Local area call.....	8-2
◇ Making a Gateway call .....	8-3
<b>About “UR?” and “RPT?” error messages</b> .....	<b>8-6</b>
◇ Shows “UR?” .....	8-6
◇ Shows “RPT?” or “RX” .....	8-6
◇ Shows “L” .....	8-6
<b>Capturing a call sign</b> .....	<b>8-7</b>
<b>“FROM” (Access repeater) setting</b> .....	<b>8-8</b>
◇ Using the preloaded repeater list .....	8-9
◇ Using the DR mode scan .....	8-10
◇ Using the Repeater Search function .....	8-11
◇ Using the TX History .....	8-13
<b>“TO” (Destination) setting</b> .....	<b>8-14</b>
◇ Using the “Local CQ” (Local Area call) .....	8-15
◇ Using the “Gateway CQ” (Gateway call).....	8-16
◇ Using the “Your Call Sign” .....	8-17
◇ Using the RX History .....	8-18
◇ Using the TX History .....	8-19
◇ Directly inputting (UR) .....	8-20
◇ Directly inputting (RPT) .....	8-21

**IMPORTANT!**

- The repeater list, described in this manual, may differ from your transceiver’s preloaded contents.
- Although Japanese repeaters are used in the setting examples, the Japanese repeater node (port) letters are different from other country’s.

Be sure to add a repeater node letter as the 8th digit in the call sign field after a repeater call sign, according to the repeater frequency band, as shown below.

1200 MHz: A (B in Japan)

430 MHz: B (A in Japan)

144 MHz: C (no D-STAR repeaters in Japan)

## D-STAR Operating procedures

This section describes the basic **D-Star** procedures.

- When it is the first time to operate D-STAR, check whether or not you can access your local area repeater (Access repeater), and if your signal is successfully sent to a destination repeater.
- If your **call sign** (MY) has not been set, or your call sign has not been registered on a D-STAR repeater, see pages 7-2 and 7-4.

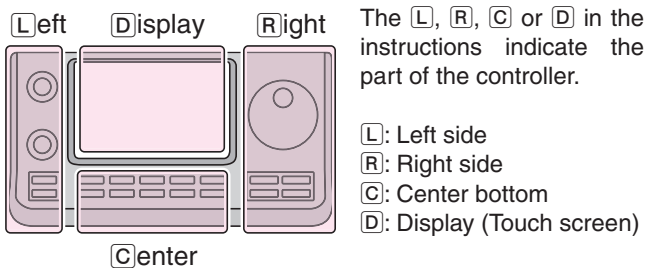

### ◇ Making a Local area call

#### 1. Set "FROM" (Access repeater)

- ① Push **DR**(**C**) to select the DR mode.
- ② Check whether or not "FROM" is selected.
  - If "FROM" is not selected, touch the "FROM" field.
- ③ Touch the "FROM" field.
  - The "FROM SELECT" screen appears.
- ④ Touch "Repeater List."
- ⑤ Touch the repeater group where your access repeater is listed.
  - Example: "11: Japan"
- ⑥ Touch your access repeater.
  - Example: "Hirano"
  - The transceiver returns to the DR mode screen, and the selected repeater is set in "FROM."

#### 2. Set "TO" (Destination)

- ⑦ Check whether or not "TO" is selected.
  - If "TO" is not selected, touch the "TO" field.
- ⑧ Touch the "TO" field.
  - The "TO SELECT" screen appears.
- ⑨ Touch "Local CQ."
- The transceiver returns to the DR mode screen, and "CQCQCQ" is set in "TO."

#### 3. Hold down [PTT] to transmit

- While holding down [PTT], the TX/RX indicator lights red.

**See page 8-6 to check whether you can access the repeater.**

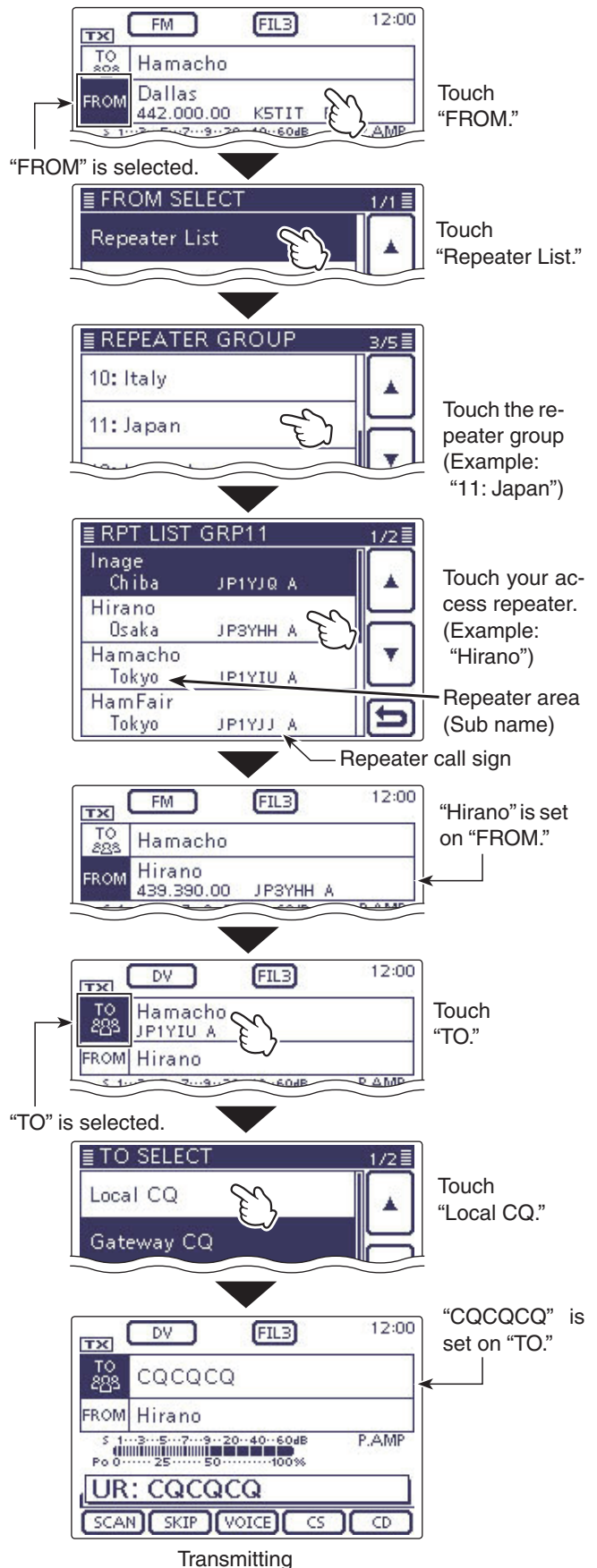

/// The repeater list, described in this manual, may differ from your transceiver's preloaded list.

D-STAR Operating procedures (Continued)

◇ Making a Gateway call

1. Set "FROM" (Access repeater)

- ① Push **DR**(**C**) to select the DR mode.
- ② Check whether or not "FROM" is selected.
  - If "FROM" is not selected, touch the "FROM" field.
- ③ Touch the "FROM" field.
  - The "FROM SELECT" screen appears.
- ④ Touch "Repeater List."
  - The "REPEATER GROUP" screen appears.
- ⑤ Touch the repeater group where your access repeater is listed.
  - Example: "11: Japan"
- ⑥ Touch your access repeater.
  - Example: "Hirano"
  - The transceiver returns to the DR mode screen, and the selected repeater is set in "FROM."

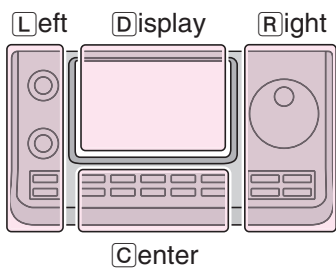

The L, R, C or D in the instructions indicate the part of the controller.

- L: Left side
- R: Right side
- C: Center bottom
- D: Display (Touch screen)

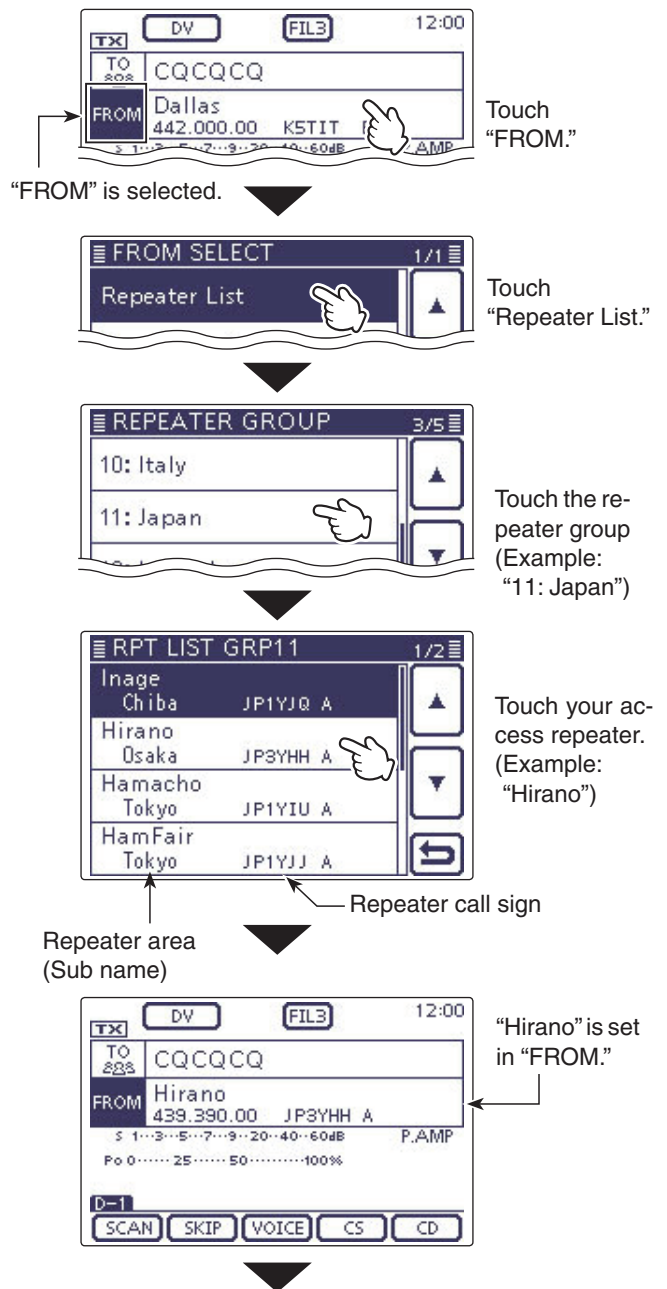

Continued on the next page.



**D-STAR Operating procedures**

◇ Making a Gateway call (Continued)

**2. Set "TO" (Destination)**

- ⑦ Check whether or not "TO" is selected.
  - If "TO" is not selected, touch the "TO" field.
- ⑧ Touch the "TO" field.
  - The "TO SELECT" screen appears.
- ⑨ Touch "Gateway CQ."
  - The "REPEATER GROUP" screen appears.
- ⑩ Touch the repeater group where your destination repeater is listed.
  - Example: "11: Japan"
- ⑪ Touch the destination repeater.
  - Example: "Hamacho"
  - The transceiver returns to the DR mode screen, and the selected repeater is set in "TO."

**3. Hold down [PTT] to transmit**

- While holding down [PTT], the TX/RX indicator lights red.

**See page 8-6 to check whether you can access the repeater.**

✓ **Convenient!**

The Gateway CQ call is used to call any repeater, but you can call a specific station by simply saying their call sign.

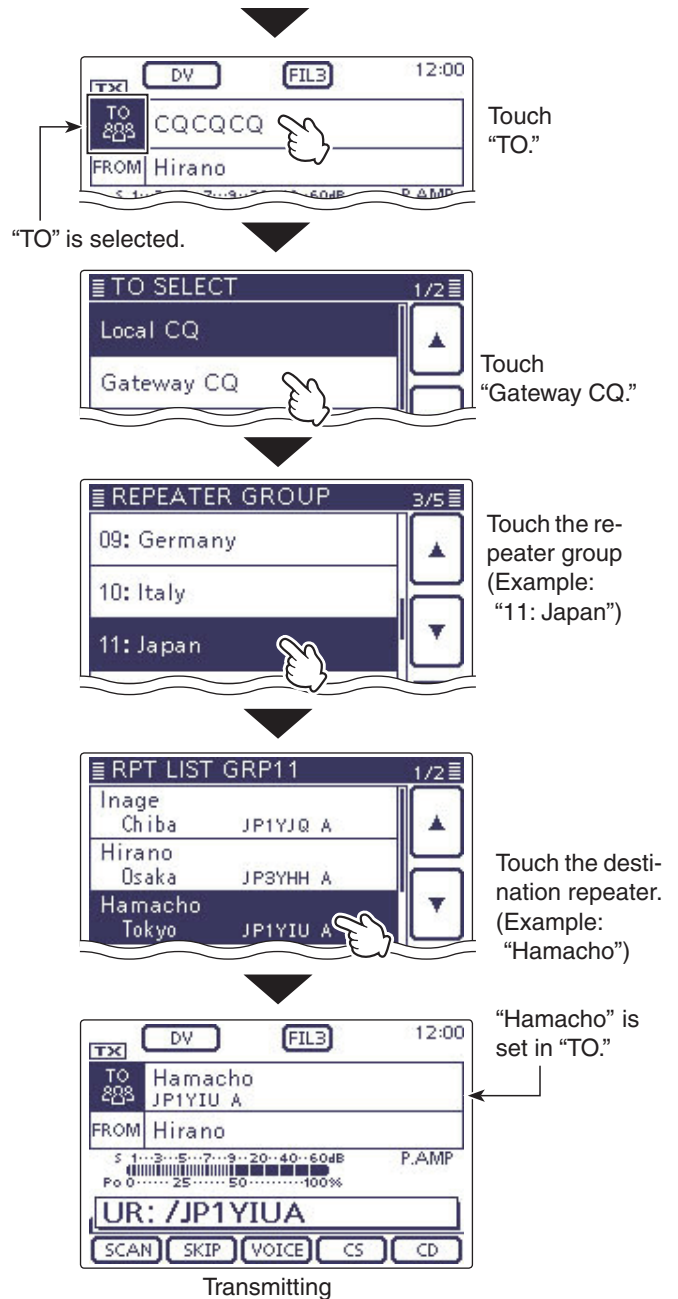

D-STAR Operating procedures (Continued)

< Communication example for a Gateway call >

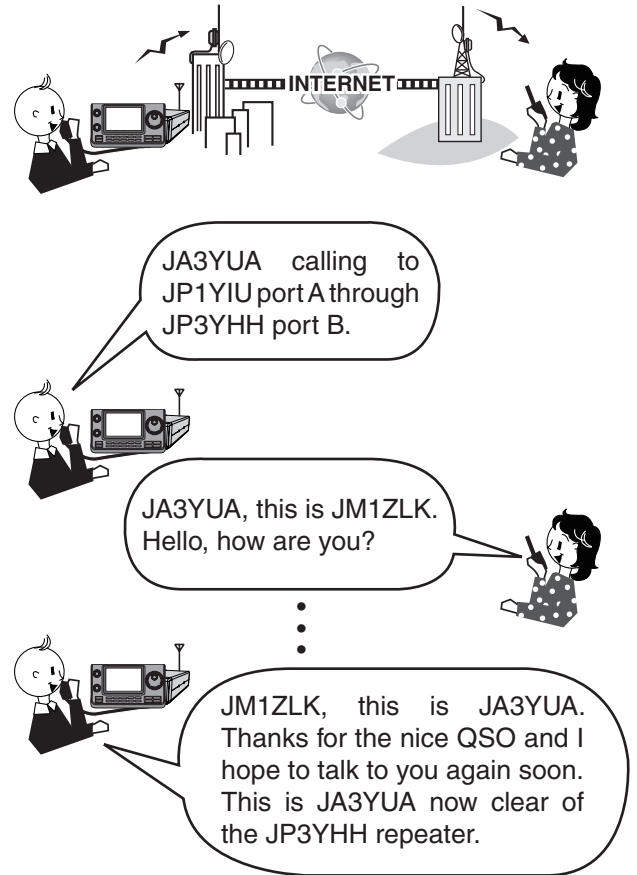

## About “UR?” and “RPT?” error messages

The transceiver includes a status message in the signal received back from the access repeater, after transmitting.

### ◆ Shows “UR?”

The call was successfully sent, but no station’s signal was received within 3 seconds.

The called station may have missed your call, so after waiting for a while, try calling again.



This means that your local area call was correctly sent from the “Hirano” repeater.



This means that your gateway call was correctly sent from the “Hirano” repeater to the “Hamacho” repeater.

### ◆ Shows “RPT?” or “RX”

The destination repeater was not found, there is a programming error, or the destination repeater was busy.

When “RPT?” is displayed, after waiting for a while, try calling again, because in a gateway call, your signal is sent even if the destination repeater is busy.

**NOTE:** “RPT?” or “RX” is displayed when:

- The repeater **call sign** programming is in error.
- Your own call sign is not registered on a gateway repeater, or the registration contents is not matched.
- The destination call sign is not registered on a gateway repeater, or the registration contents is not matched.
- The destination repeater call sign is not registered on a gateway repeater, or the registration contents is not matched.
- The destination repeater cannot be accessed.
- A blank MY call sign memory is selected. (“RX” is displayed)



This means that your gateway call was sent from the “Hirano” repeater to the “Hamacho” repeater, but the “Hamacho” repeater was busy at the time.

### ◆ Shows “L”

While operating in the voice communication or low-speed data communication mode through the internet, some packets may be lost due to network error, or the caller’s signal is weak getting into the repeater. In such a case, “L” is displayed to indicate that Packet Loss has occurred.

When the transceiver receives corrupted data, and misidentifies it as Packet Loss, “L” is displayed, even if it is a Local area call.

Indicates packet loss



“L” blinks while packet loss is occurring.

## Capturing a call sign

After you receive the repeater's signal, the calling station's call sign can be captured by holding down the **Call Sign Capture** key **AUTO TUNE/RX>CS** (R). Then you can quickly and easily reply to the received call.

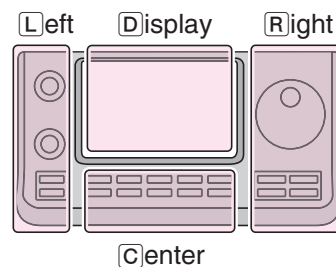

The **L**, **R**, **C** or **D** in the instructions indicate the part of the controller.

- L**: Left side
- R**: Right side
- C**: Center bottom
- D**: Display (Touch screen)

### 1. Set the received call sign to the destination

Hold down **AUTO TUNE/RX>CS** (R) for 1 second.

- After releasing, beeps sound, and the station call sign is announced if the RX>CS Speech function is set to ON in the "SPEECH" Set mode.

**SET** (C) > **SPEECH** > **RX>CS SPEECH**

- If you want to select another call sign in the RX history, rotate [DIAL] while holding down **AUTO TUNE/RX>CS** (R).

**NOTE:** When a received signal is weak, or during DR mode scanning, the call sign may not be received correctly. In that case, "-----" appears, an error beep sounds, and a quick reply call cannot be made.

### 2. Hold down [PTT] to transmit

- While holding down [PTT], the TX/RX indicator lights red.

**NOTE:** Push **AUTO TUNE/RX>CS** (R) or **DR** (C), or touch "FROM" on the DR mode screen to cancel the Call Sign Capture mode, and return to the previous call sign setting.

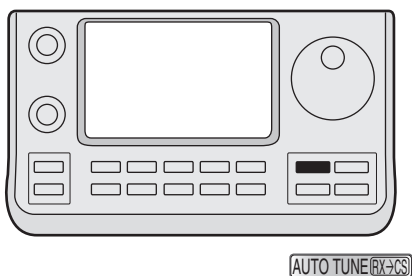

When receiving a call from "JG3LUK."

While receiving

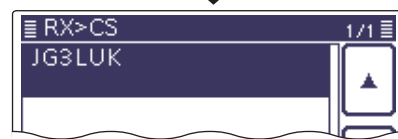

Beeps

While holding down **AUTO TUNE/RX>CS** (R)

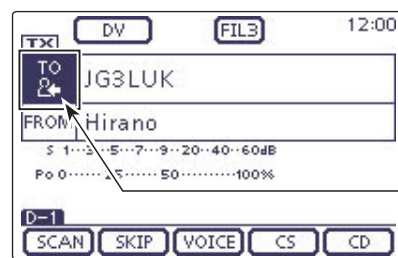

JG3LUK

Appears after selecting a call sign.

After releasing **AUTO TUNE/RX>CS** (R)



Transmitting

## “FROM” (Access repeater) setting

Your access repeater must be set to “FROM” when you transmit a call in the DR mode.

You have four ways to set the access repeater.

Click the title shown below to jump to the specified page.

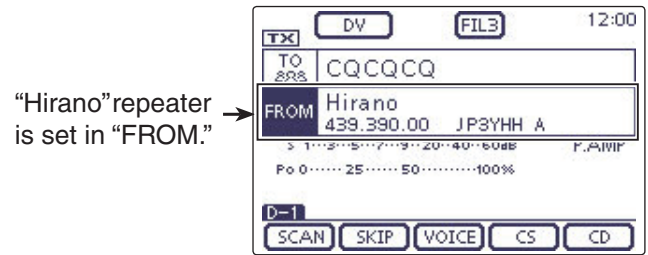

DR mode screen

### Setting by the Dial

Select the preset repeater by rotating the Dial or [M-CH] (L) on the DR mode screen. Or, rotating [BANK] (L) selects the repeater group.

### • When you know your access repeater

#### From the repeater list (p. 8-9)

When your access repeater is preloaded in your transceiver’s repeater list, you can select it by selecting the repeater area or name.

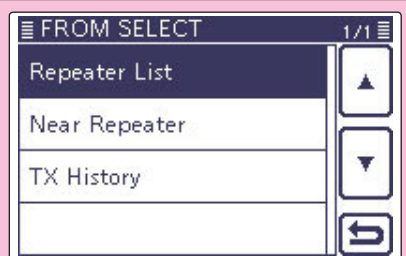

### • When you don't know which repeater you can access.

#### Search for a repeater using the DR mode scan (p. 8-10)

Searches for DV signals from a repeater or a simplex frequency.



While DR mode scanning

#### Search for the nearest repeater (p. 8-11)

Searches for the nearest repeater by using your own and the repeater’s location.

The nearest repeaters in your transceiver’s repeater list are displayed as the available choices.

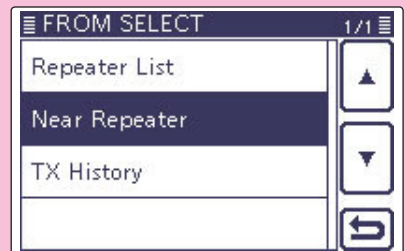

### • When the “FROM” data is stored in the TX History.

#### Setting from the TX History (p. 8-13)

Select a repeater that you have accessed before, from the TX History record.

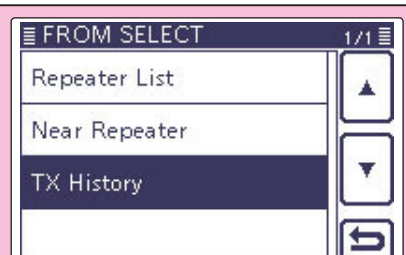

**“FROM” (Access repeater) setting (Continued)**

**◇ Using the preloaded repeater list**

When your access repeater is preloaded in your transceiver’s repeater list, you can select it from the repeater list.

By only selecting the repeater from the list, the **call sign**, frequency, **duplex** and offset frequency settings are automatically set for easy operation.

**Example:** Select the “Hirano” repeater in Japan from the repeater list.

- ① Push **DR**(**C**) to select the DR mode.
- ② Check whether or not “FROM” is selected.
  - If “FROM” is not selected, touch the “FROM” field.
- ③ Touch the “FROM” field.
  - The “FROM SELECT” screen appears.
- ④ Touch “Repeater List.”
  - The “REPEATER GROUP” screen appears.
- ⑤ Touch the repeater group where your access repeater is listed. (Example: “11: Japan”)
- ⑥ Touch your access repeater to select the repeater area or name. (Example: “Hirano”)
  - The transceiver returns to the DR mode screen, and the selected repeater is set in “FROM.”

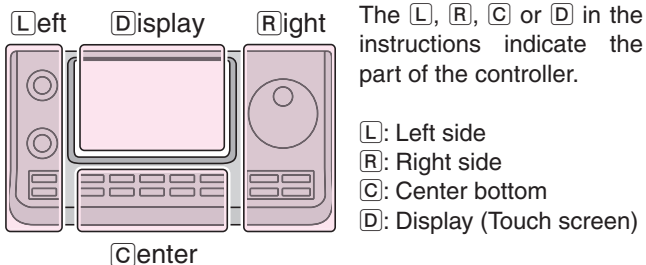

**How to switch the repeater group:**

➤ To switch the repeater group, while in the DR mode, push **QUICK**(**C**), and then touch “Group Select”

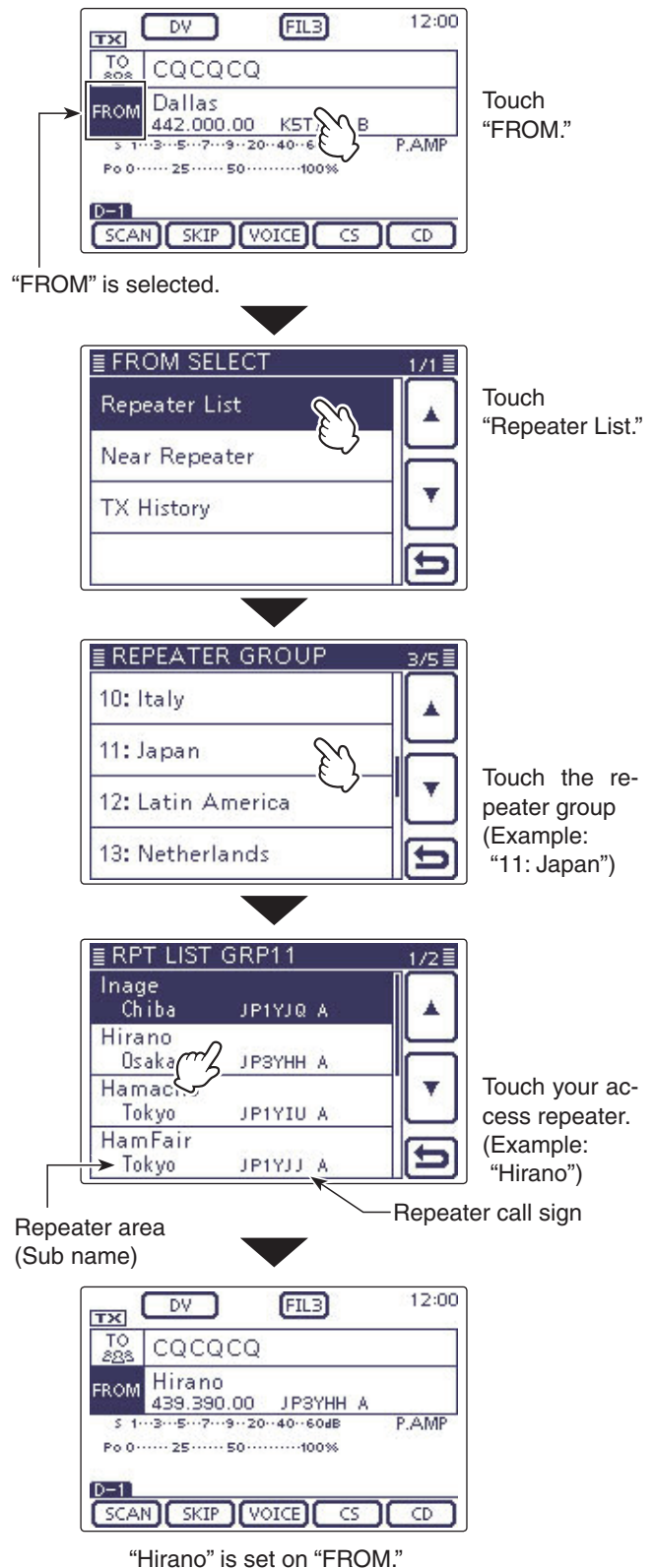

/// The repeater list, described in this manual, may differ from your transceiver’s preloaded list.



**“FROM” (Access repeater) setting (Continued)**

**◇ Using the DR mode scan**

The DR mode scan is useful to find a repeater. To quickly find a repeater, the DR mode scan skips repeaters that are not specified as an access repeater. (The “USE (FROM)” setting is set to “NO” (SKIP is set) on the repeater list.)

**Example:** Select the “Hirano” repeater using the DR mode scan.

- ① Push **[DR]**(C) to select the DR mode.
- ② Push **[MENU]**(C) to display the “D-1” screen (D-1 menu).
- ③ Touch **[SCAN]**(D) to start the DR mode scan.
  - The frequency decimal point and “FROM” blink while scanning.
  - The repeaters in the repeater list are sequentially displayed.
  - The scan pauses when a signal is received. The scan resumes the same as other scans. (p. 12-5)
- ④ When the transceiver receives a signal from a repeater, the scan stops, then touch **[SCAN]**(D).
  - The DR mode scan is cancelled.

/// You can skip certain repeaters as a scan target. You can also skip all repeaters in certain groups from a scan. See page 9-42 for details.

/// **NOTE:**  
Even if the transceiver receives a signal from a repeater, the repeater may not receive the transceiver’s signal, because the repeater’s output power is higher than the transceiver’s.

The DR mode scan also scans simplex frequencies if they are entered in the repeater list.

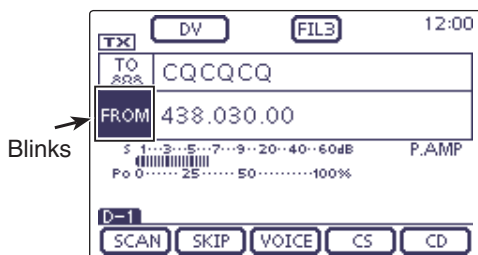

While receiving a signal on 438.030.

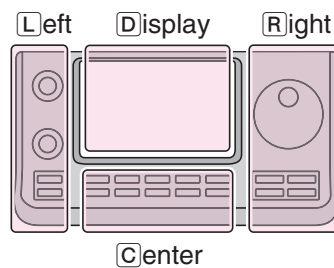

The **[L]**, **[R]**, **[C]** or **[D]** in the instructions indicate the part of the controller.

- [L]**: Left side
- [R]**: Right side
- [C]**: Center bottom
- [D]**: Display (Touch screen)

Touch **[SCAN]**

Blinks

The repeaters are sequentially displayed.

While DR mode scanning

Means “JM1ZLK” is using the “Hirano” repeater.

Touch **[SCAN]**

While receiving a signal from a repeater

“Hirano” repeater is selected in “FROM.”

**“FROM” (Access repeater) setting (Continued)**

**◇ Using the Repeater Search function**

The transceiver searches for the nearest repeater by using your own and the repeater’s position. The nearest repeater in your transceiver’s repeater list is displayed as the available choices.

To receive your own position, connect an external NMEA format compatible receiver to the transceiver according to the instructions. (See page 10-2 for connecting the third party GPS receiver)

If you set your position into the “Manual” item of the “GPS Set” Set mode, and if you use the transceiver as a base station, you can use the Repeater Search function without needing to receive any other position data. (See page 10-2 for Manual position entry)

**1. Receiving your own position from the GPS receiver**

- ① Push **SET**(C) to select the Set mode.
- ② Touch the “GPS Select” item of the “GPS Set” Set mode.
  - GPS > GPS Set > **GPS Select**
    - If the specified item is not displayed, touch [▲] or [▼](D) one or more times to select the page.
- ③ Touch “External GPS.”
  - When you know your position and operate as a base station, the Repeater Search function can be used if “Manual” is selected.
- ④ Push **SET**(C) to save, and exit the Set mode.
  - The GPS icon blinks when receiving data.
    - If “Manual” was selected, the icon does not appear.
    - ⇄ ■ ⇄ ■ ⇄ (Disappears)
  - The GPS icon stops blinking when valid data is received.
    -
  - It may take only a few seconds to receive. But depending on the environment, it may take a few minutes. If you have difficulties receiving, we recommend that you try a different location.

▨ If the “DATA 1” item in the “Connectors” Set mode is set to other than “GPS” (default), set to “GPS.” (p. 17-25)  
 Connectors > USB2/DATA1 Function > **DATA1 Function**

▨ Set the “GPS Receiver Baud rate” item in the “GPS” Set mode, according to your GPS receiver. (Default: 4800)  
 GPS > GPS Set > **GPS Receiver Baud rate**

The **L**, **R**, **C** or **D** in the instructions indicate the part of the controller.  
**L**: Left side, **R**: Right side, **C**: Center bottom  
**D**: Display (Touch screen)

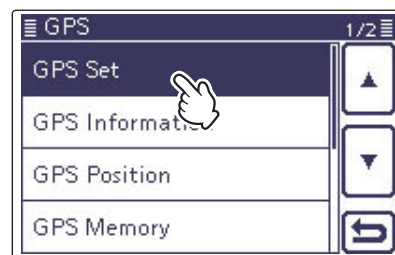
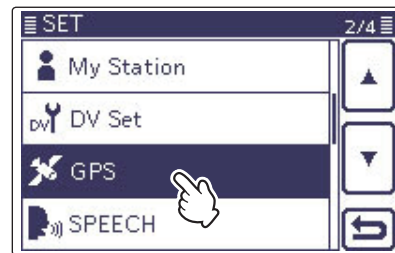

“GPS Select” screen

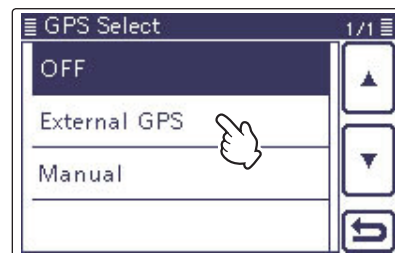

Appears when valid data is received.

In the DR mode

Continued on the next page.



**“FROM” (Access repeater) setting**

◇ Using the Repeater Search function (Continued)

**2. Selecting the access repeater from the Near Repeater list**

- ① Push **DR**(**C**) to select the DR mode.
- ② Check whether or not “FROM” is selected.
  - If “FROM” is not selected, touch the “FROM” field.
- ③ Touch the “FROM” field.
  - The “FROM SELECT” screen appears.
- ④ Touch “Near Repeater.”
  - The “NEAR REPEATER” screen appears.
  - Up to 20 of the nearest repeaters are displayed.
- ⑤ Touch the repeater as your access repeater, according to the distance from your position to the repeater.
  - Example: “Hirano”
  - The transceiver returns to the DR mode screen, and the selected repeater is set in “FROM.”

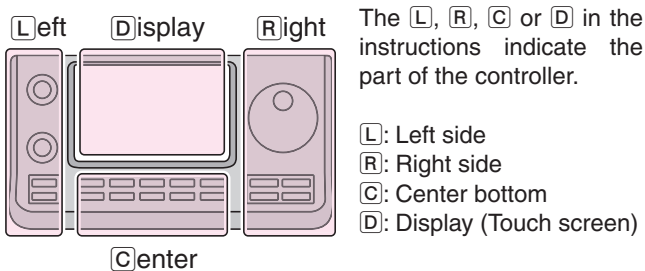
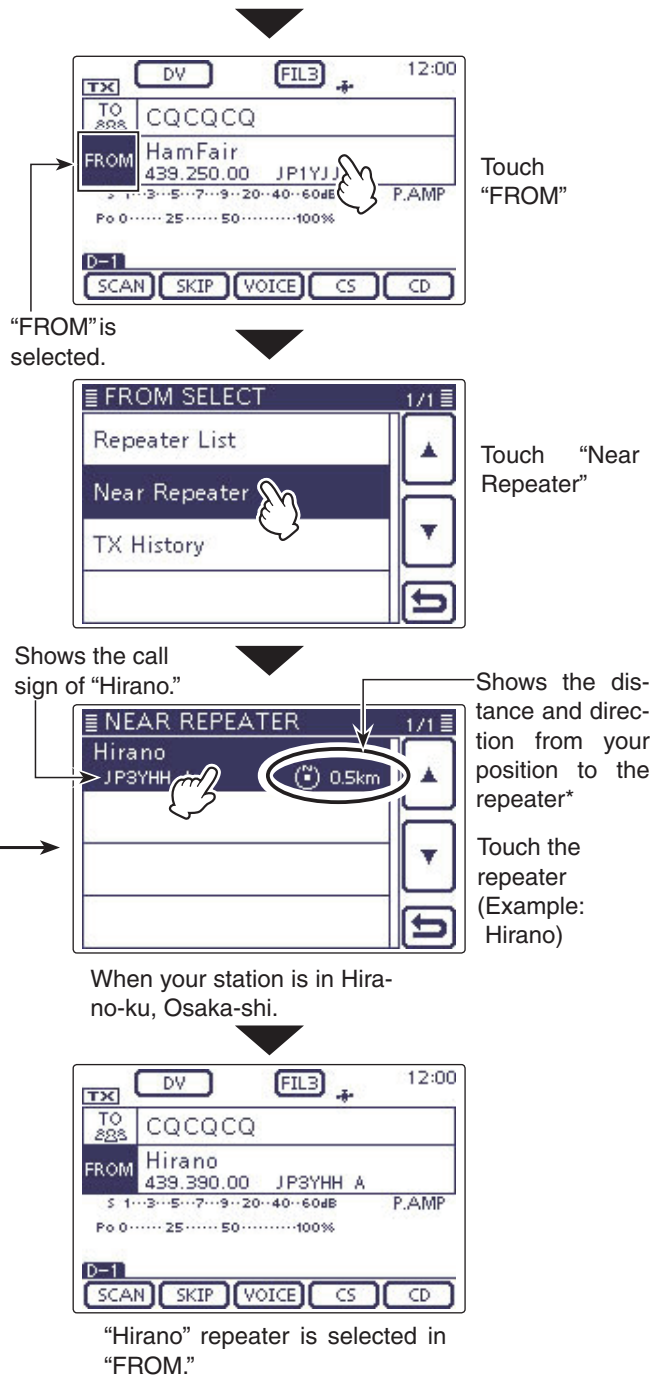

**NOTE:**  
 When using the Repeater Search function, be sure to first receive your own position data.

- If no repeater is found in a 160 kilometers range, screen 1, as shown to the right, will be displayed.
- If the last received position can be used, screen 2, as shown to the right, will be displayed.

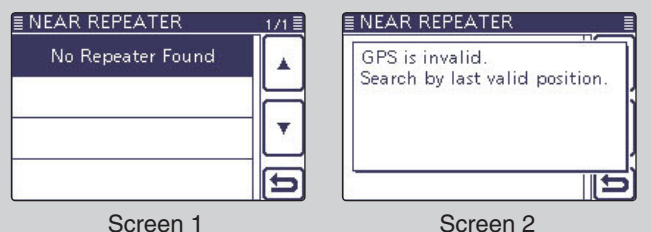

**“FROM” (Access repeater) setting (Continued)**

**◇ Using the TX History**

Repeaters you transmitted to in the DR mode are stored in the TX History, and you can select a repeater from the TX History as your access repeater. The TX History stores up to 10 of the latest “FROM” (Access repeater) repeaters.

- ① Push **DR**(**C**) to select the DR mode.
- ② Check whether or not “FROM” is selected.
  - If “FROM” is not selected, touch the “FROM” field.
- ③ Touch the “FROM” field.
  - The “FROM SELECT” screen appears.
- ④ Touch “TX History.”
  - The “TX HISTORY” screen appears.
- ⑤ Touch the repeater to use as your access repeater.
  - Example: “Hirano”
  - The transceiver returns to the DR mode screen, and the selected repeater is set in “FROM.”

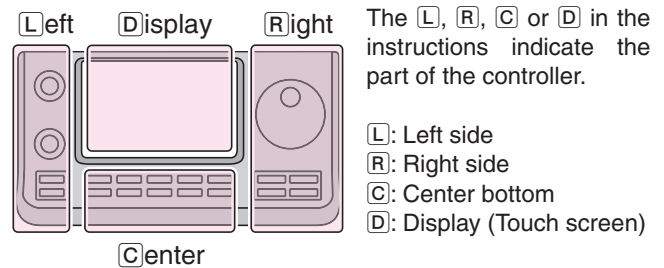

When you push **QUICK**(**C**) in the step ④, you can display detailed repeater information on the TX HISTORY screen, or delete it from there.



Touch “FROM”

“FROM” is selected.

Touch “TX History”

Touch the repeater (Example: Hirano)

“Hirano” repeater is selected in “FROM.”

## “TO” (Destination) setting

The destination repeater or station must be set to “TO” when you transmit a call in the DV mode. You have eight ways to set the destination. Click the title shown below to jump to the specified page.

“Hamacho” repeater is set in “TO.”



### Setting by the Dial

Rotate the Dial or [M-CH] (L) to select the preset repeater or Your Call Sign that is displayed on the DR mode screen. (This operation is disabled when “CQCQCQ” is set.)

Or, rotate [BANK] (L) to select the repeater group.

To make a Local Area CQ call

**“Local CQ” setting (p. 8-15)**  
Set “CQCQCQ” in “TO” (Destination).

To make a Gateway CQ call

**“Gateway CQ” setting (p. 8-16)**  
Select a repeater from the repeater list, if you want to make a Gateway CQ call.

To make a call to a specific station

**“Your Call Sign” setting (p. 8-17)**  
Select the station call sign in the Your Call Sign memory.

To select from RX History

**Setting from RX History (p. 8-18)**  
When you receive a call, the repeater or caller station data is stored in RX History. You can select the destination from the record.

To select from TX History

**Setting from TX History (p. 8-19)**  
When you transmit a call, the destination repeater or called station data is stored in TX History. You can select the destination from the record.

To directly input the destination station call sign

**Direct Input (UR) (p. 8-20)**  
Directly input the destination station call sign.

To directly input the destination repeater call sign

**Direct Input (RPT) (p. 8-21)**  
Directly input the destination repeater call sign.

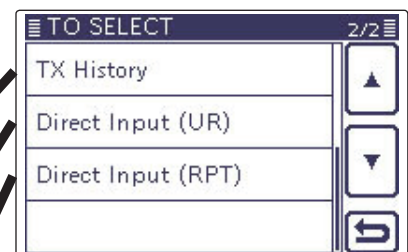

[TO SELECT] screen

### How to switch the repeater group:

When “Local CQ” or “Gateway CQ” is selected, you can switch the repeater group.

While in the DR mode, push [QUICK] (C), and then touch “Group Select.”



**“TO” (Destination) setting (Continued)**

**◇ Using the “Local CQ” (Local Area call)**

When “Local CQ” is selected in the “TO SELECT” screen, “CQCQCQ” is set in “TO.”

**Example:** Making a Local area call by accessing the “Hirano” repeater.

- ① Push **DR**(**C**) to select the DR mode.
- ② Check whether or not “TO” is selected.
  - If “TO” is not selected, touch the “TO” field.
- ③ Touch the “TO” field.
  - The “TO SELECT” screen appears.
- ④ Touch “Local CQ.”
  - The transceiver returns to the DR mode screen, and “CQCQCQ” is displayed in “TO.”

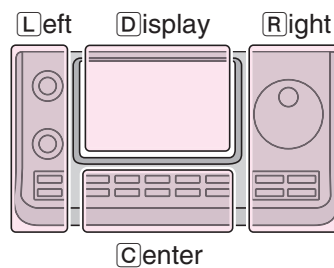

The **L**, **R**, **C** or **D** in the instructions indicate the part of the controller.

- L**: Left side
- R**: Right side
- C**: Center bottom
- D**: Display (Touch screen)



Touch “TO.”

“TO” is selected.

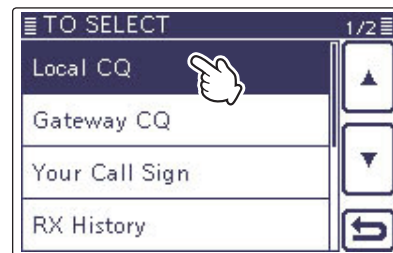

Touch “Local CQ.”



“CQCQCQ” is set in “TO.”

**“TO” (Destination) setting (Continued)**

**◇ Using the “Gateway CQ” (Gateway call)**

When “Gateway CQ” is selected in the “TO SELECT” screen, the repeater to make a gateway CQ call can be selected from the repeater list.

**Example:** Making a gateway CQ call to (Japan; Hamacho) from the “Hirano” repeater.

- ① Push **[DR]**(**[C]**) to select the DR mode.
- ② Check whether or not “TO” is selected.
  - If “TO” is not selected, touch the “TO” field.
- ③ Touch the “TO” field.
  - The “TO SELECT” screen appears.
- ④ Touch “Gateway CQ.”
  - The “REPEATER GROUP” screen is displayed.
- ⑤ Touch the repeater group where your destination repeater is listed.
  - Example: “11: Japan”
- ⑥ Touch the destination repeater.
  - Example: “Hamacho”
  - The transceiver returns to the DR mode screen, and “Hamacho” is displayed in “TO.”

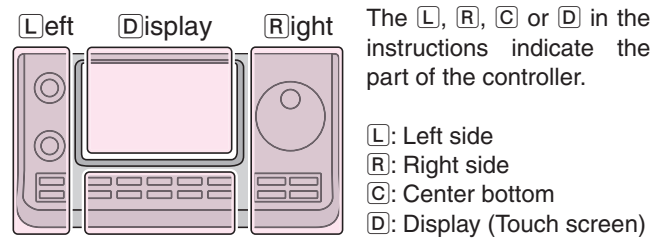

Touch “TO.”

“TO” is selected.

Touch “Gateway CQ.”

Touch the repeater group (Example: “11: Japan”)

Touch the destination repeater (Example: Hamacho)

“Hamacho” is set in “TO.”

After selecting a repeater, you can select another repeater preset in your transceiver by rotating **[DIAL]** or **[M-CH]**(**[L]**).

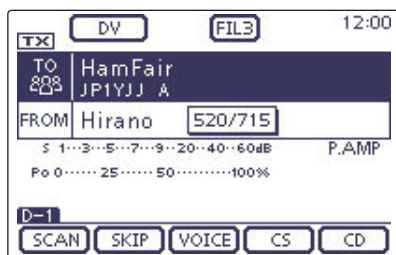

Or, you can select another repeater group by rotating **[BANK]**(**[L]**).





**“TO” (Destination) setting (Continued)**

**◇ Using the “Your Call Sign”**

The “Your Call Sign” memory stores the programmed “UR” (destination) **call sign**.

When you select an individual station call sign for the “TO” (Destination) setting using “Your Call Sign,” a gateway call can be made.

When you call the destination through a gateway, the signal is automatically sent to the last repeater that the station accessed.

So, even if you don't know where the station is, you can make a call.

**NOTE:** If the repeater, set to “FROM” (Access Repeater) has no Gateway call sign, you cannot make a gateway call.

**Example:** Select “TOM” from the “Your Call Sign.”

- ① Push **DR**(**C**) to select the DR mode.
- ② Check whether or not “TO” is selected.
  - If “TO” is not selected, touch the “TO” field.
- ③ Touch the “TO” field.
  - The “TO SELECT” screen appears.
- ④ Touch “Your Call Sign.”
  - The “YOUR CALL SIGN” screen is displayed.
- ⑤ Touch the destination name or call sign.
  - Example: “TOM”
  - The transceiver returns to the DR mode screen, and “TOM” is displayed in “TO.”

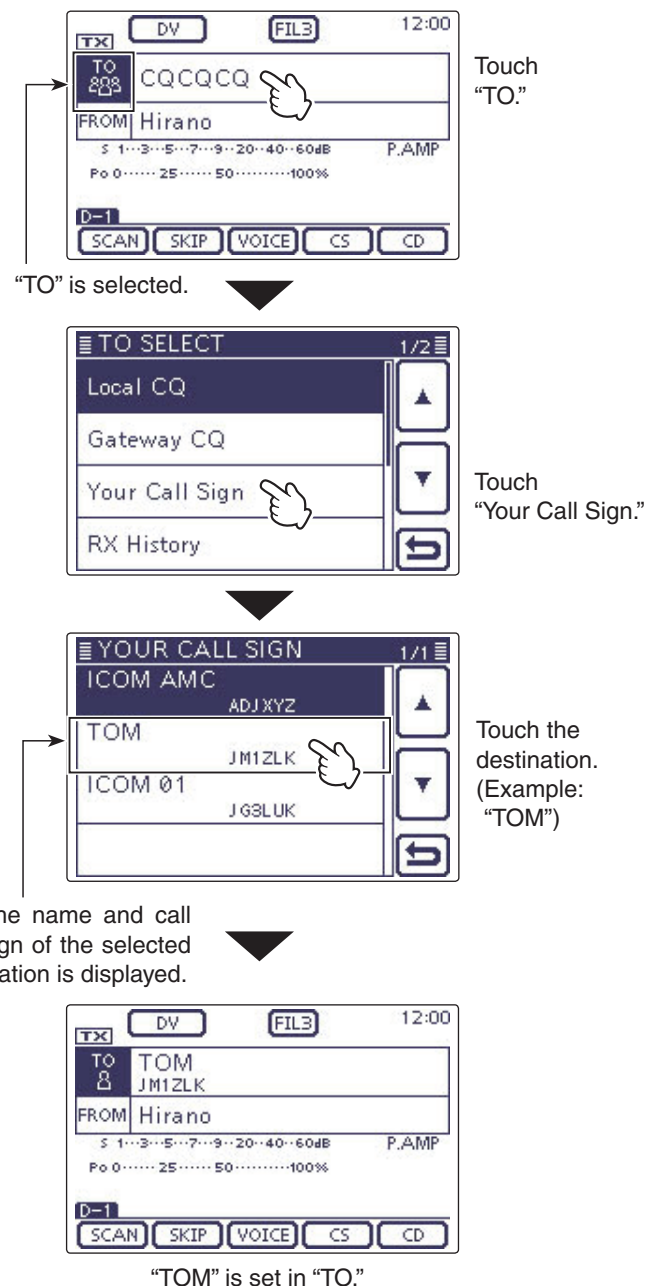
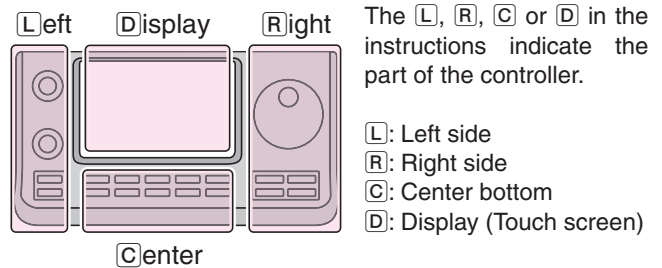

After selecting a destination, you can select another station preset in your transceiver by rotating the Dial or **[M-CH]**(**L**).

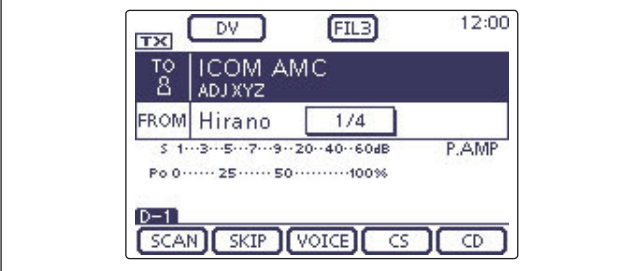

**"TO" (Destination) setting (Continued)**

**◇ Using the RX History**

When a call is received in the DV mode, the call data is stored in the RX History.

Up to 50 Callers, and only the last Called **call signs** can be stored.

**Example:** Select "TOM" from RX History.

- ① Push **DR**(**C**) to select the DR mode.
- ② Check whether or not "TO" is selected.
  - If "TO" is not selected, touch the "TO" field.
- ③ Touch the "TO" field.
  - The "TO SELECT" screen appears.
- ④ Touch "RX History."
  - The "RX HISTORY" screen appears.
- ⑤ Touch the destination name or call sign.
  - Example: "TOM"
  - The transceiver returns to the DR mode screen, and "TOM" is displayed in "TO."

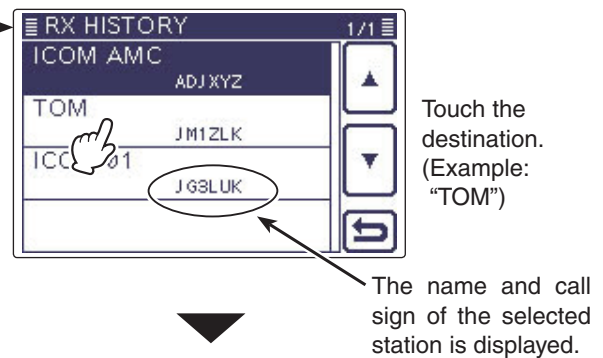
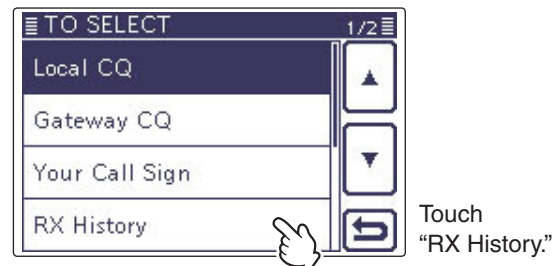
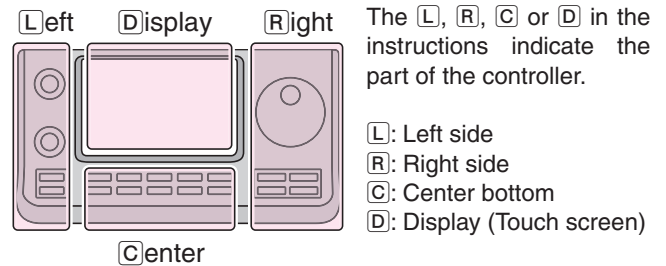

To add the selected RX HISTORY data to memory, push **QUICK**(**C**) on the RX HISTORY screen, then touch "Add To your Memory."



**“TO” (Destination) setting (Continued)**

**◇ Using the TX History**

The TX History stores the name and/or **call sign** of up to 20 “TO” (Destination) settings that were used when you made the calls.

**NOTE:** If you never transmit a call in the DV mode, you cannot select “TO” (destination) from the TX History.

**Example:** Select the “Dallas” repeater in the TX History.

- ① Push **DR**(**C**) to select the DR mode.
- ② Check whether or not “TO” is selected.
  - If “TO” is not selected, touch the “TO” field.
- ③ Touch the “TO” field.
  - The “TO SELECT” screen appears.
- ④ Touch **[▼]** to display the next page.
- ⑤ Touch “TX History.”
  - The “TX HISTORY” screen appears.
- ⑥ Touch the destination name or call sign.
  - Example: “Dallas”
  - The transceiver returns to the DR mode screen, and “Dallas” is displayed in “TO.”

The **L**, **R**, **C** or **D** in the instructions indicate the part of the controller.  
**L**: Left side, **R**: Right side, **C**: Center bottom  
**D**: Display (Touch screen)



“TO” is selected.

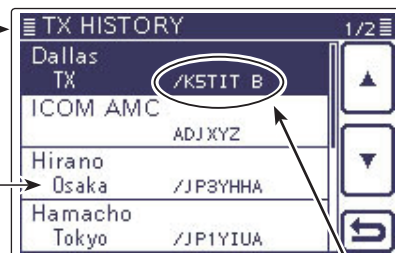
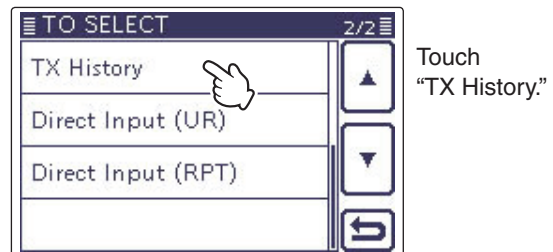
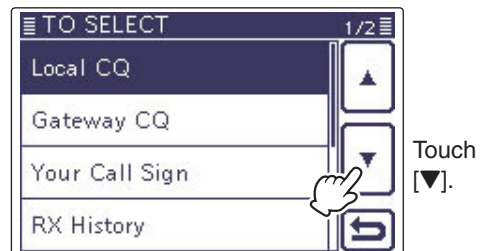

The Sub name is displayed when a repeater is selected.

“Dallas” repeater’s call sign is displayed.



“Dallas” is set in “TO.”

If you push **QUICK**(**C**) on the TX HISTORY screen, you can add the selected TX HISTORY data to memory, or delete it from there.





**“TO” (Destination) setting (Continued)**

**◇ Directly inputting (UR)**

The destination station call sign can be directly input.

**Example:** Directly input the call sign “JM1ZLK.”

- ① Push **[DR]**(C) to select the DR mode.
- ② Check whether or not “TO” is selected.
  - If “TO” is not selected, touch the “TO” field.
- ③ Touch the “TO” field.
  - The “TO SELECT” screen appears.
- ④ Touch **[▼]** to display the next page.
- ⑤ Touch “Direct Input (UR).”
  - The “DIRECT INPUT (UR)” screen appears.
- ⑥ Touch the desired block one or more times to select the desired character or symbol.
  - (Example: J)
  - A to Z, 0 to 9 and / can be selected.
  - Touch “AB↔12” to toggle between the Alphabet input and Number input mode.
  - Touch **[CLR]**(D) to delete the selected character, symbol or number.
  - Touch “\_” to input a space.
- ⑦ Touch **[←]**(D) to move the cursor backwards, or touch **[→]**(D) to move the cursor forwards.
- ⑧ Repeat steps ⑥ and ⑦ to program a call sign of up to 8 characters, including spaces, and then touch **[ENT]**(D).
  - (Example: First, J, then M, then 1, then Z, then L, then K.)
  - The transceiver returns to the DR mode screen, and “JM1ZLK” is displayed in “TO.”
  - After programming, you can correct the call sign in the DIRECT INPUT (UR) screen.
  - The programmed call sign remains on the DIRECT INPUT (UR) screen, until inputting a new call sign.

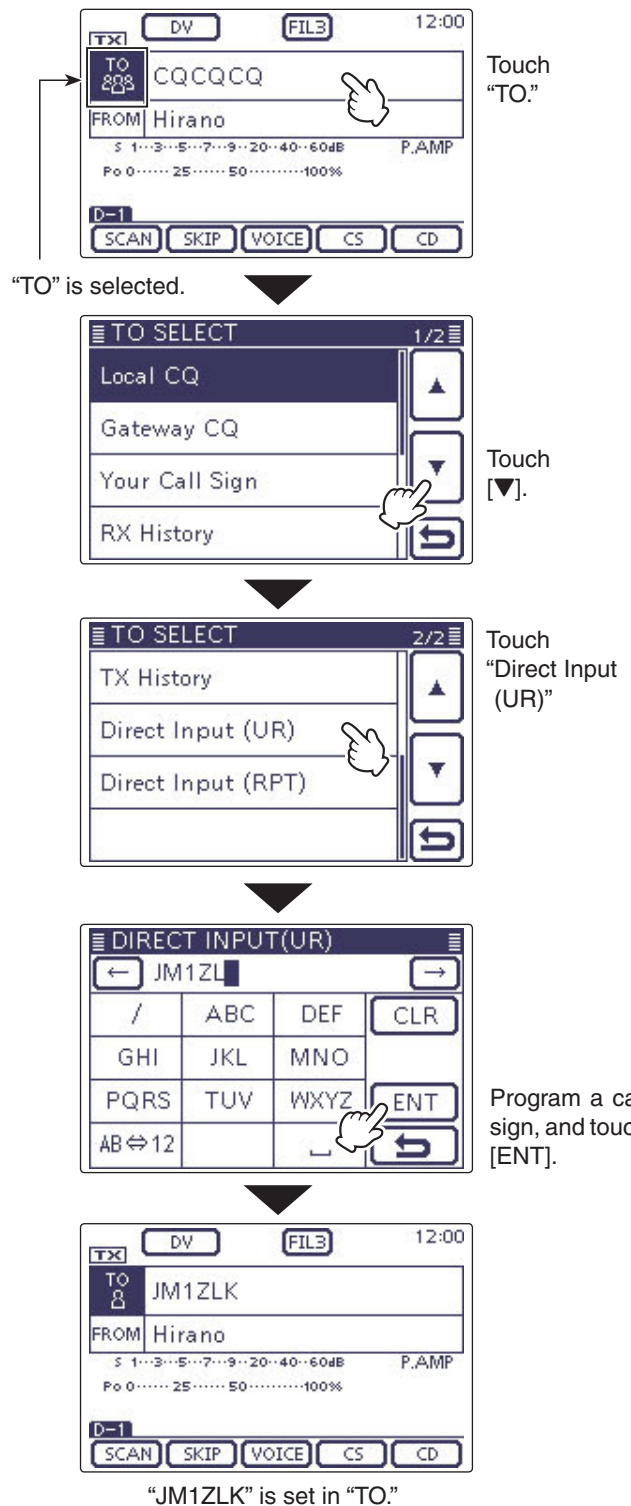
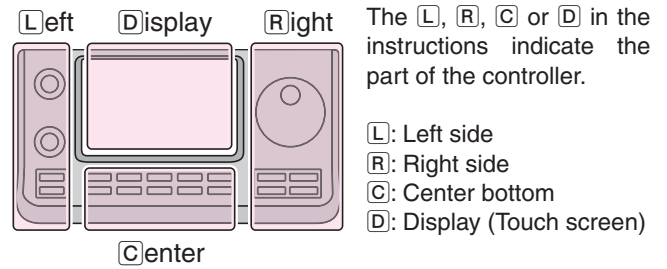

If the programmed call sign is duplicated in “Your Call Sign” memory, the name is displayed. (Only when the name has been programmed.)



**“TO” (Destination) setting (Continued)**

**◇ Directly inputting (RPT)**

The destination repeater call sign can be directly input.

**Example:** Directly input the call sign “JP3YDH”

- ① Push **DR**(**C**) to select the DR mode.
- ② Check whether or not “TO” is selected.
  - If “TO” is not selected, touch the “TO” field.
- ③ Touch the “TO” field.
  - The “TO SELECT” screen appears.
- ④ Touch **[▼]** to display the next page.
  - The “TO SELECT” screen appears.
- ⑤ Touch “Direct Input (RPT).”
  - The “DIRECT INPUT (RPT)” screen appears.
- ⑥ Touch the desired block one or more times to select the desired character or symbol.
  - (Example: J)
  - A to Z, 0 to 9 and / can be selected.
  - Touch “AB↔12” to toggle between the Alphabet input and Number input mode.
  - Touch **[CLR]**(**D**) to delete the selected character, symbol or number.
  - Touch “\_” to input a space.
- ⑦ Touch **[←]**(**D**) to move the cursor backwards, or touch **[→]**(**D**) to move the cursor forwards.
- ⑧ Repeat steps ⑥ and ⑦ to program a call sign of up to 8 characters, including spaces, and then touch **[ENT]**(**D**).
  - (Example: First, J, then P, then 3, then Y, then D, then H.)
  - The transceiver returns to the DR mode screen, and “JP3YDH” is displayed in “TO.”
  - After programming, you can correct the call sign in the DIRECT INPUT (RPT) screen.
  - The programmed call sign remains on the DIRECT INPUT (RPT) screen, until inputting a new call sign.

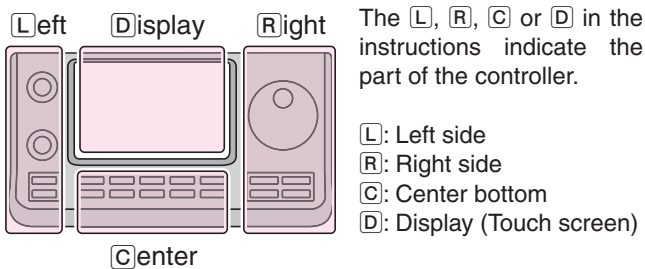
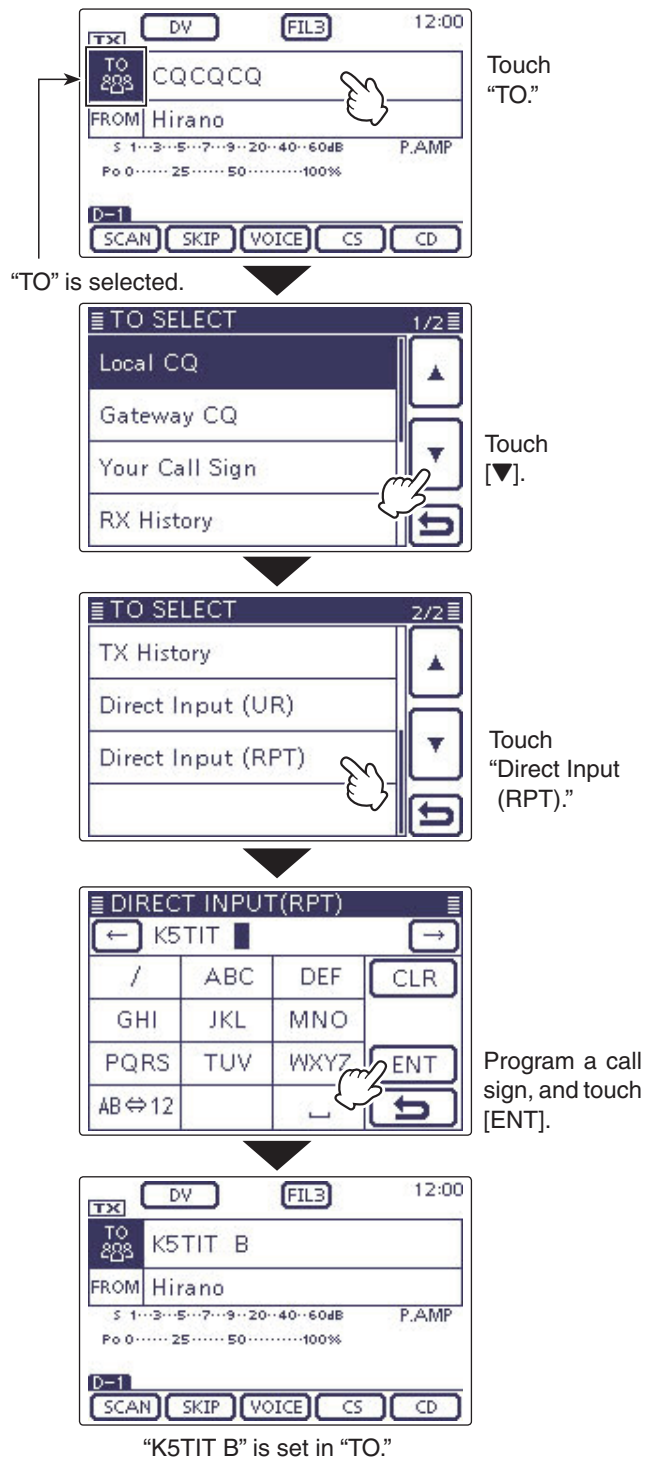

If the programmed call sign is duplicated to the repeater list, the name is displayed. (Only when the name has been programmed.)

The following settings are also correct.

The repeater node\* is input.

“/” is input. In this case, the call sign is of a repeater for a Gateway call.

\*Although the repeater node letter is ‘B’ for 430 MHz band, ‘A’ is used in Japan. See page 8-1 for details.

<b>Message operation</b> .....	<b>9-2</b>
◇ TX message programming.....	9-2
◇ Message Transmission.....	9-5
◇ TX message deleting .....	9-6
<b>Received call sign viewing</b> .....	<b>9-7</b>
◇ View in the RX History screen .....	9-7
<b>BK mode communication</b> .....	<b>9-9</b>
<b>EMR communication</b> .....	<b>9-10</b>
◇ Adjusting the EMR AF level .....	9-11
<b>Display type setting</b> .....	<b>9-12</b>
<b>DV automatic detection</b> .....	<b>9-13</b>
<b>Automatic Reply function</b> .....	<b>9-14</b>
◇ Recording an Auto Reply voice announcement.....	9-15
◇ Playing back the recorded voice audio .....	9-15
◇ Received Auto Reply Position Data .....	9-16
<b>Low-speed data communication</b> .....	<b>9-17</b>
◇ Connection.....	9-17
◇ Low-speed data communication application setting .....	9-17
◇ Low-speed data communication operation .....	9-17
<b>Speech function</b> .....	<b>9-18</b>
◇ To announce the received call sign.....	9-18
◇ To announce the RX>CS call sign .....	9-19
◇ Speech Language selection.....	9-20
◇ Phonetic Code setting for the Speech alphabet character.....	9-20
◇ Speech speed selection.....	9-21
◇ Speech level selection .....	9-21
<b>Digital squelch functions</b> .....	<b>9-22</b>
◇ The digital call sign squelch setting .....	9-22
◇ The digital code squelch setting.....	9-22
◇ Digital code setting.....	9-23
<b>Viewing the call signs</b> .....	<b>9-24</b>
<b>Changing the Call sign setting</b> .....	<b>9-25</b>
◇ Simplex operation .....	9-25
◇ For Duplex (repeater) operation.....	9-26
<b>Repeater list</b> .....	<b>9-28</b>
◇ Repeater list contents .....	9-28
<b>Repeater list programming</b> .....	<b>9-29</b>
◇ Required items for the communication cases .....	9-29
◇ New repeater programming .....	9-29
<b>Editing a repeater list</b> .....	<b>9-38</b>
<b>Deleting a repeater list</b> .....	<b>9-39</b>
<b>Rearrange the display order of the repeater</b> .....	<b>9-40</b>
<b>Adding the Repeater information using the RX History</b> .....	<b>9-41</b>
<b>Skip setting for the DR mode scan</b> .....	<b>9-42</b>
◇ Individual skip setting.....	9-42
◇ Group skip setting.....	9-42
<b>Repeater group name programming</b> .....	<b>9-43</b>
<b>Repeater detail screen</b> .....	<b>9-44</b>
<b>Your (destination) call sign programming</b> .....	<b>9-45</b>
<b>Editing a Your (destination) call sign</b> .....	<b>9-47</b>
<b>Rearrange the display order of Your (destination) call sign</b> .....	<b>9-48</b>
<b>Deleting Your (destination) call sign</b> .....	<b>9-49</b>
<b>Your setting is correct?</b> .....	<b>9-50</b>

**IMPORTANT!**

• The repeater list, described in this manual, may differ from your transceiver's preloaded contents.

• Although Japanese repeaters are used in the setting examples, the Japanese repeater node (port) letters are different from other country's.

Be sure to add a repeater node letter as the 8th digit in the **call sign** field after a repeater call sign, according to the repeater frequency band, as shown below.

1200 MHz: A (B in Japan)

430 MHz: B (A in Japan)

144 MHz: C (no **D-STAR** repeaters in Japan)

## Message operation

The transceiver has a total of 5 message memories to store short messages to transmit during DV mode operation.

TX messages of up to 20 characters can be programmed in each of the 5 message memories.

### ◇ TX message programming

#### 1. Display the TX Message Edit screen

- ① Push **SET**(**C**) to enter the Set mode.
- ② Touch the "TX Message" item of the "My Station" Set mode.  
 My Station > **TX Message**
  - If the specified item is not displayed, touch [**▲**] or [**▼**](**D**) one or more times to select the page.
- ③ Touch the desired message memory number field for 1 second.  
 (Example: 1:)
- ④ Touch "Edit."  
 • The "TX Message" screen appears.

**Example:** To program "JAPAN >TOM" into message memory number 1.

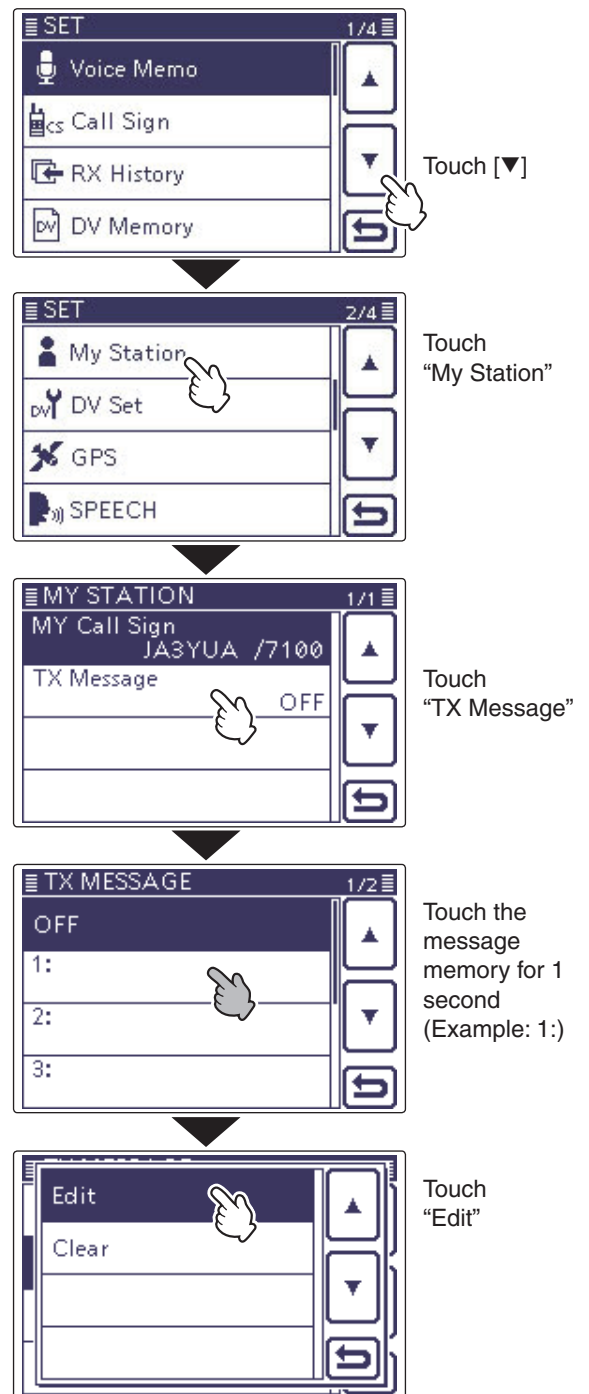

Continued on the next page

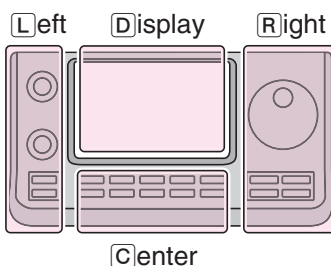

The **L**, **R**, **C** or **D** in the instructions indicate the part of the controller.

- L**: Left side
- R**: Right side
- C**: Center bottom
- D**: Display (Touch screen)

Message operation (Continued)

2. Enter the TX message

- ⑤ Touch the desired block one or more times to select the desired character or symbol.  
(Example: J)

Selectable characters and symbols
A to Z, a to z, 0 to 9, ! # \$ % & \ ? " ' ` ^ + - * / . , ; = < > ( ) [ ] { }   _ ` @ (space)

- Touch "AB<=>12" to toggle between the Alphabet input and Number input mode.
- Touch [CLR](D) to delete the selected character, symbol or number.
- Touch [ [AB] ](D) to open the input mode selection window.
- Touch " \_ " to input a space.
- ⑥ Touch [←](D) to move the cursor backwards, or touch [→](D) to move the cursor forwards.
- ⑦ Repeat steps ⑤ and ⑥ to enter up to 20 characters, including spaces.  
(Example: First, J, then A, then P, then A, then N, then (space), then >, then T, then O, then M.)
- ⑧ Touch [ENT](D) to return to the "TX Message" screen.

Tx message edit screen

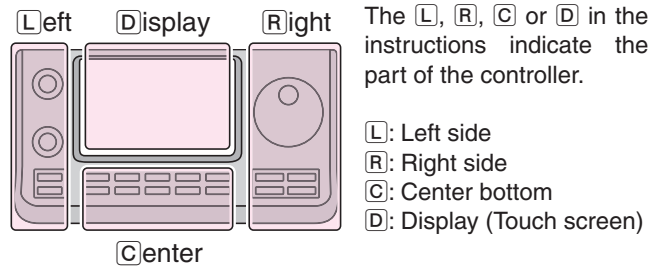
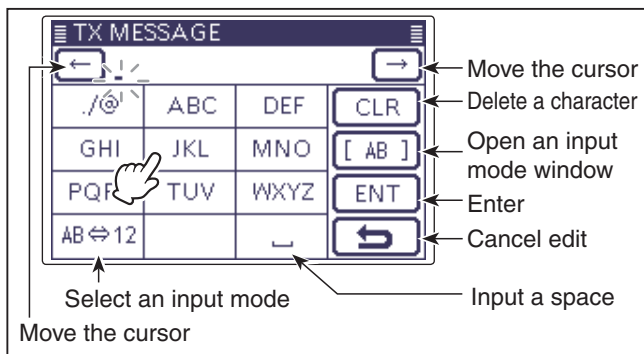

Enter "JAPAN >TOM" into [1:].

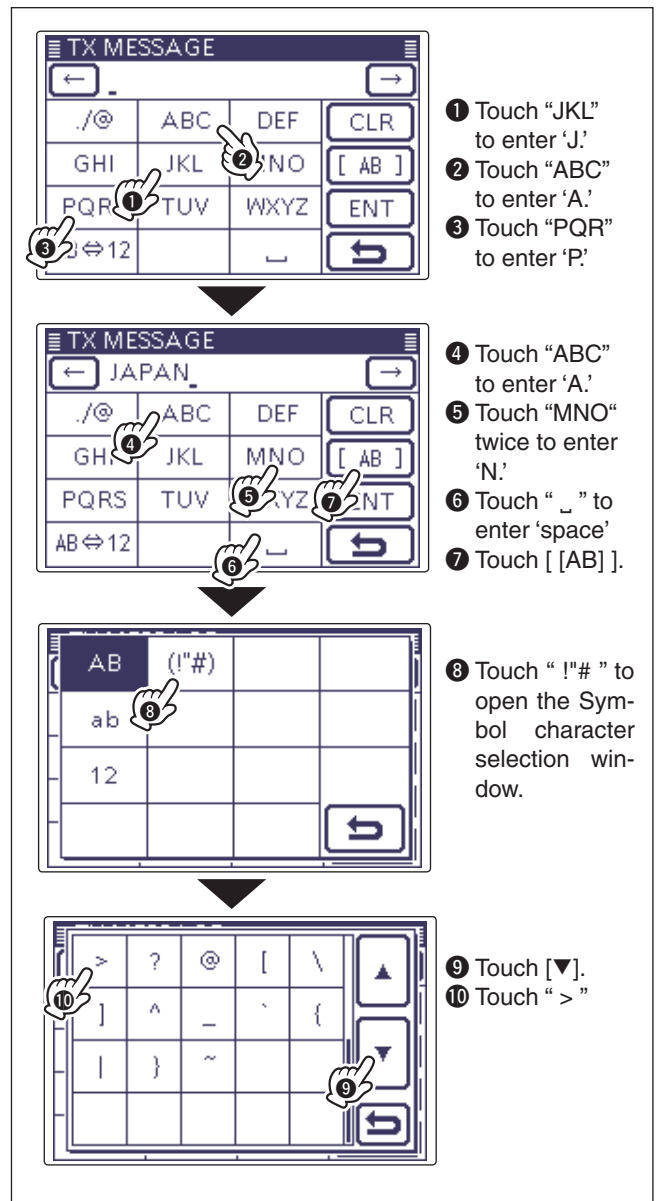

Continued on the next page

**Message operation**

2. Enter the TX message (Continued)

- ⑨ Touch the entered TX message to set the message to be used.
- ⑩ Push **SET**(C) to exit the Set mode.

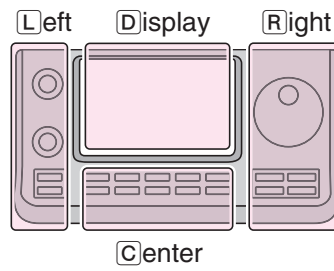

The **L**, **R**, **C** or **D** in the instructions indicate the part of the controller.

- L**: Left side
- R**: Right side
- C**: Center bottom
- D**: Display (Touch screen)

⑪ Touch "TUV" to enter 'T.'

⑫ Touch "MNO" three times to enter 'O.'

⑬ Touch "MNO" to enter 'M.'

⑭ Touch [ENT].

Push **SET**



**Message operation (Continued)**

**◇ Message Transmission**

You can transmit a preprogrammed text message by pushing [PTT] on the microphone. First, select a TX message which also turns ON the message transmission function.

- ① Push **SET**(C) to enter the Set mode.
- ② Touch the "TX Message" item of the "My Station" Set mode.  
 My Station > **TX Message**
  - If the specified item is not displayed, touch [▲] or [▼](D) one or more times to select the page.
- ③ Touch the number to select message memory number 1 to 5.
  - To turn OFF the message transmission function, select "OFF."
- ④ Push **SET**(C) to exit the Set mode.
  - The message is transmitted along with your voice signal.
  - The message is transmitted each time you push [PTT] on the microphone.
  - The message is automatically transmitted every 30 seconds during continuous transmission.

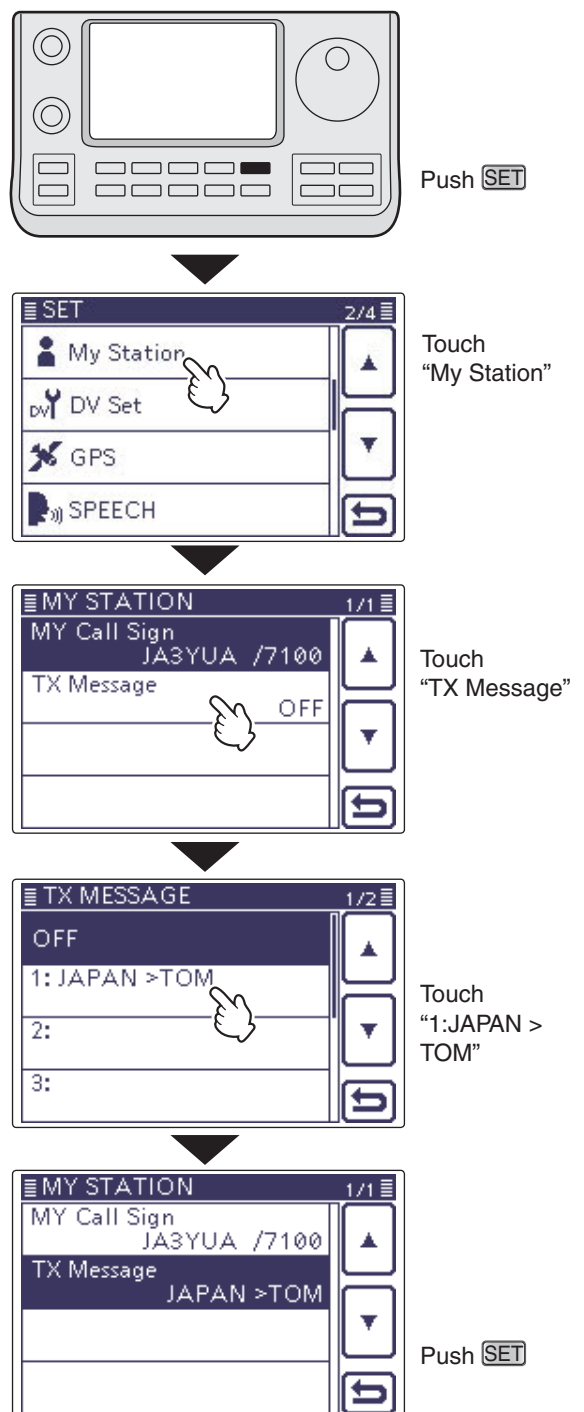
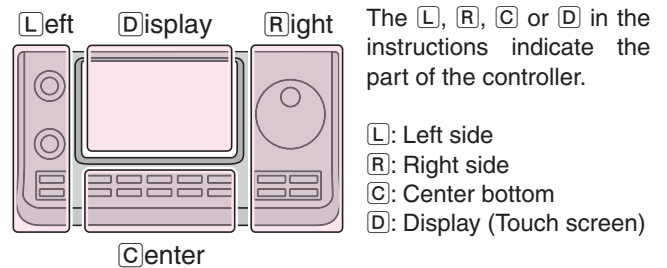

**RX message display function**

As the default, the received message is automatically displayed and scrolled on the LCD.

To not display and scroll the received message, turn OFF the RX message display function in "RX Message Display" of the Set mode. (p. 17-27)

**SET**(C) > Display > **RX Message Display**

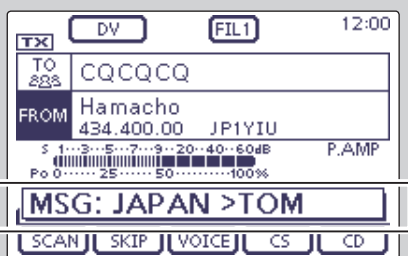

The received message is displayed and scrolled here.



Message operation (Continued)

◇ TX message deleting

The programmed TX message can be deleted, as described below.

- ① Push **SET**(**C**) to enter the Set mode.
- ② Touch the "TX Message" item of the "My Station" Set mode.  
My Station > **TX Message**
  - If the specified item is not displayed, touch [**▲**] or [**▼**](**D**) one or more times to select the page.
- ③ Touch the desired message memory number for 1 second.  
(Example: 1:)
- ④ Touch the "Clear" item.  
• The confirmation screen "Clear?" appears.
- ⑤ Touch **[YES]**(**D**).
- ⑥ Push **SET**(**C**) to exit the Set mode.

**Example:** To delete the programmed TX message "JAPAN >TOM" from message memory number 1.

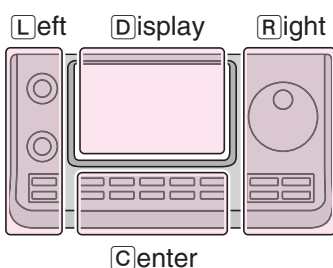
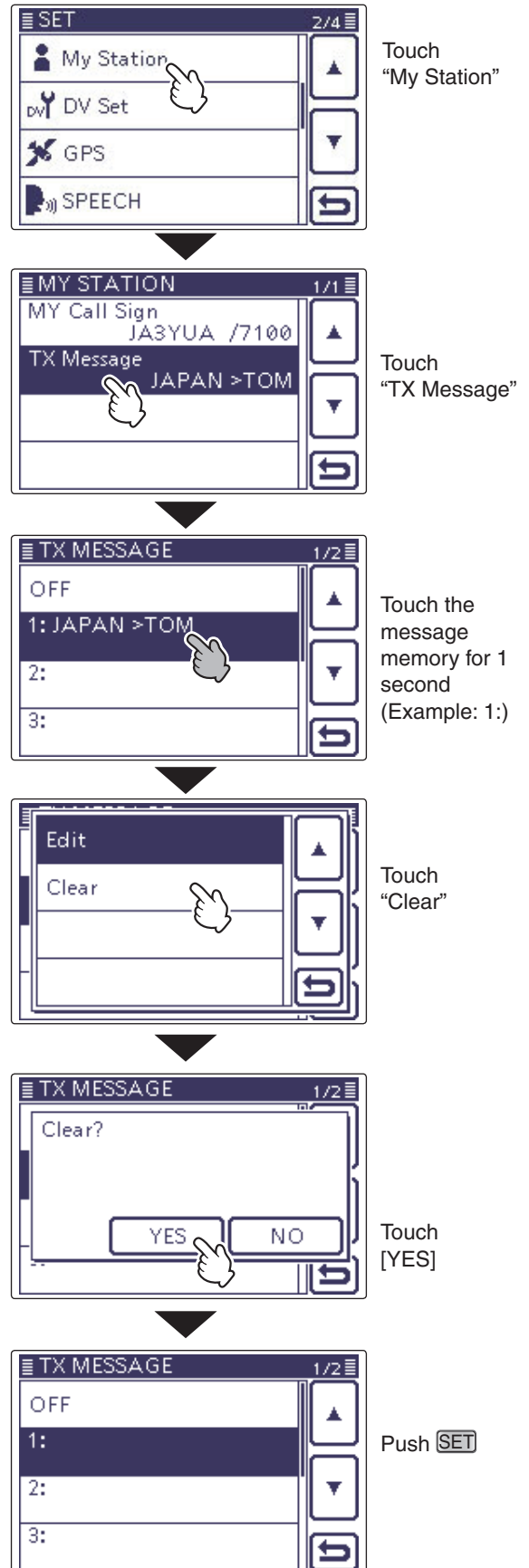

The **L**, **R**, **C** or **D** in the instructions indicate the part of the controller.

- L**: Left side
- R**: Right side
- C**: Center bottom
- D**: Display (Touch screen)

## Received call sign viewing

When a DV call is received, the calling station and the repeater's **call signs** are stored in the RX HISTORY screen.

Up to 50 calls can be stored.

Even if the transceiver is turned OFF, the RX record won't be deleted.

The stored call signs can be displayed in the following manner.

### ◇ View in the RX History screen

- ① Push **[DR]**(C) to enter the DR mode.
- ② Touch **[CD]**(D) to display the "RX HISTORY" screen.
  - "RX HISTORY" can be displayed in the Set mode.
  - [SET]**(C) > **RX History**
- ③ Touch **[▲]** or **[▼]**(D) to select an RX history number between "RX01" and "RX50".
  - In addition to the RX history number, the call signs of the caller and called station, RX message, Repeater call sign of the called station, received date and time are displayed on the LCD.
  - If only one call is received, skip step ③.
  - "GW" appears when the gateway call is received.
  - "GPS" appears when the received call includes GPS position.
  - "UP" appears when the repeater uplink signal is received.
- ④ Touch the screen to show the contents of the RX history.
- ⑤ Touch **[▲]** or **[▼]**(D) to switch the displayed contents of the RX history.
  - **CALLER:** Shows the call sign of the caller station and any note programmed after the call sign.
  - **CALLED:** Shows the call sign of the called station.
  - **RXRPT1\*:** Shows the call sign of the repeater that was accessed by the caller station. If it was a call through a gateway and the internet, this item displays the gateway repeater call sign of your local area repeater.
  - **Rx RPT2\*:** Shows the call sign of the repeater you received the call from.
  - **MESSAGE:** Shows any message included in the received call, if programmed.
  - **RX TIME:** Shows the date and time the call was received.
  - \* "FREQUENCY" appears instead of these items when the call was not through a repeater (Simplex call), to show the frequency that was used.
- ⑥ Push **[SET]**(C) to exit the screen.

The **[L]**, **[R]**, **[C]** or **[D]** in the instructions indicate the part of the controller.

**[L]**: Left side, **[R]**: Right side, **[C]**: Center bottom  
**[D]**: Display (Touch screen)

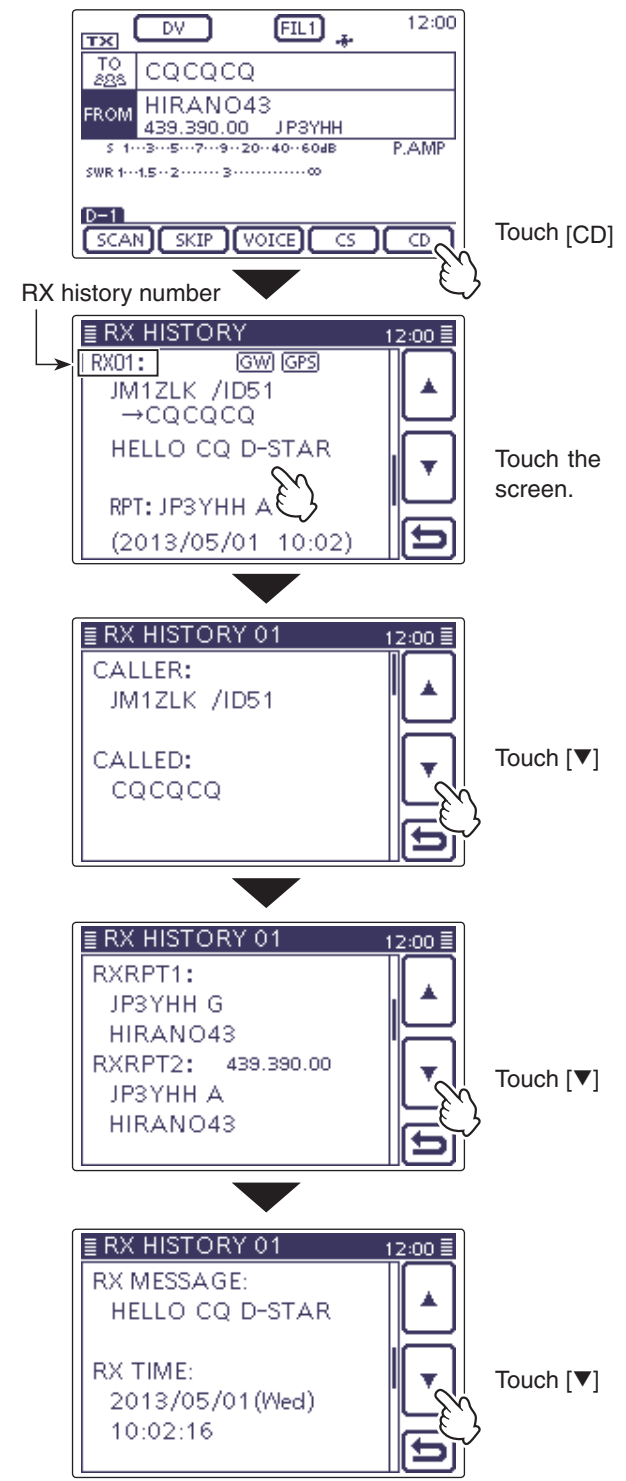

When the received call includes the GPS position data, it is displayed after RX TIME.

Received call sign viewing (Continued)

You can delete the RX HISTORY data.  
 ➔ Push **QUICK**(C) on the RX HISTORY or the contents screen, then push **▲** or **▼**(D) to select "Delete" or "Delete All."

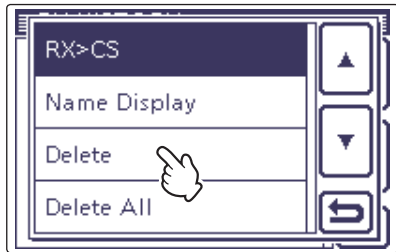

When the received call includes GPS position data.

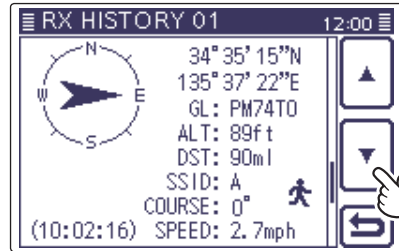

Touch **▼**

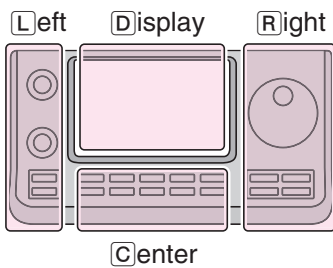

The **L**, **R**, **C** or **D** in the instructions indicate the part of the controller.

- L**: Left side
- R**: Right side
- C**: Center bottom
- D**: Display (Touch screen)

**C**enter



Push **SET**

✓ **Information**

"RX RPT1" setting may differ, depending on the communication form.

Example: When a Local area call is received.

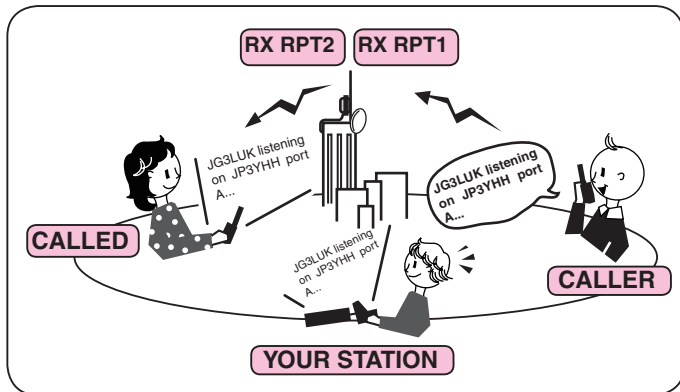

Example: When a Gateway call is received.

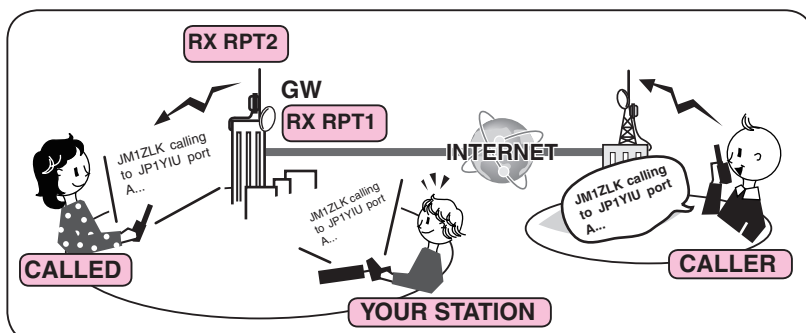

## BK mode communication

The BK (Break-in) function allows you to break into a conversation, where the two other stations are communicating with call sign squelch enabled. (Default: OFF)

**NOTE:** The BK function is automatically turned OFF when transceiver is turned OFF.

- ① After receiving a DV conversation, hold down **AUTO TUNE (RX>CS) (R)** for 1 second.
  - After releasing **AUTO TUNE (RX>CS) (R)**, beeps sound, and the calling station call sign is announced. (RX>CS Speech function)
  - The calling station or call sign of the repeater used is automatically set.
  - When a call sign is not received correctly, error beeps sound, and no call sign is set.
- ② Push **SET (C)** to enter the Set mode.
- ③ Touch the "BK" item of the "DV Set" Set mode.
  - DV Set > **BK**
    - If the specified item is not displayed, touch **[▲]** or **[▼](D)** one or more times to select the page.
- ④ Touch "ON."
- ⑤ Push **SET (C)** to exit the Set mode.
  - "BK" appears.
- ⑥ When both stations are in standby, push [PTT] on the microphone or switch ON the external TX switch to transmit.
  - The TX/RX indicator lights red.
  - "BK" blinks on the station that receives the break-in call.
- ⑦ Release [PTT] or Switch OFF the external TX switch to receive.
  - Wait for a reply call from the station.
- ⑧ After receiving the reply call, communicate normally.
- ⑨ To cancel the BK mode, select "OFF" in the "BK" item as step ④, or turn OFF the power.

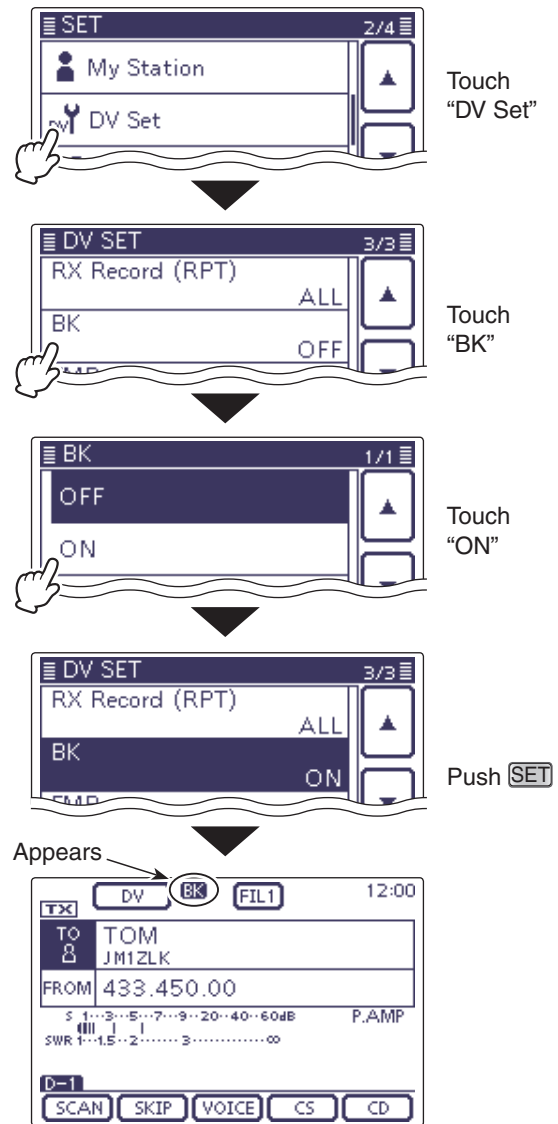

### How to use Break-in?

While using digital call sign squelch, the squelch never opens (no audio is heard) even if a call is received, unless your own call sign is specified.

However, when a call including the "BK ON" signal (break-in call) is received, the squelch will open and audio is heard even if the call is specified for another station.

#### • Station C calling to Station A with "BK OFF"

Station A and B are communicating using digital call sign squelch.

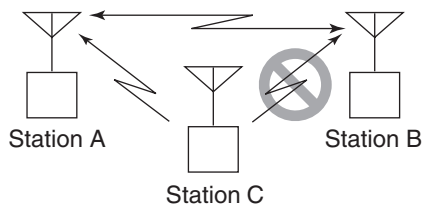

Station B never hears that Station C is calling Station A.

#### • Station C calling to Station A with "BK ON"

Station A and B are communicating using the digital call sign squelch.

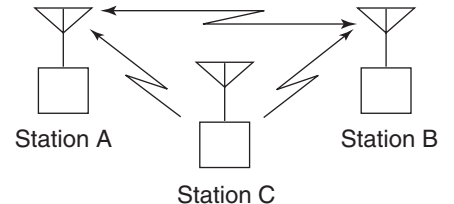

Station B also hears that Station C is calling Station A.

## EMR communication

The EMR (Enhanced Monitor Request) communication mode can be used in only the DV mode. In the EMR mode, no **call sign** setting is necessary.

All transceivers that receive an EMR mode signal automatically open their squelch to receive the signal. When an EMR mode signal is received, the audio (voice) will be heard at the specified level, even if the volume setting level is set to the minimum level, or digital call sign/digital code squelch is in use. (Default: OFF)

**NOTE:** The EMR communication function is automatically turned OFF when the transceiver is turned OFF.

- ① Push **DR**(**C**) to enter the DR mode.
  - The DR mode is selected.
- ② Touch the "FROM" field.
  - The "FROM SELECT" screen appears.
- ③ Touch "Repeater List."
  - The "REPEATER GROUP" screen appears.
- ④ Touch the repeater group where your access repeater is listed.
  - Example: "11: Japan"
- ⑤ Touch your access repeater.
  - Example: "Hamacho"
  - "Hamacho" is displayed in "FROM."
- ⑥ Push **SET**(**C**) to enter the Set mode.
- ⑦ Touch the "EMR" item of the DV SET Set mode.
  - DV Set > **EMR**
  - If the specified item is not displayed, touch **▲** or **▼**(**D**) one or more times to select the page.
- ⑧ Touch "ON."
- ⑨ Push **SET**(**C**) to exit the Set mode.
  - "EMR" appears.
- ⑩ Push [PTT] on the microphone or switch ON the external TX switch to transmit.
  - The TX/RX indicator lights red.
  - "EMR" blinks on a station that receives the EMR signal. The audio (voice) will be heard at the specified level, or the [AF]**○**(**L**) control level, whichever is higher.
- ⑪ Release [PTT] or Switch OFF the external TX switch to receive.
- ⑫ To cancel the EMR mode, select "OFF" in step ⑧, as described above, or turn OFF the power.

**Example:** To transmit from the "Hamacho" repeater in the EMR mode

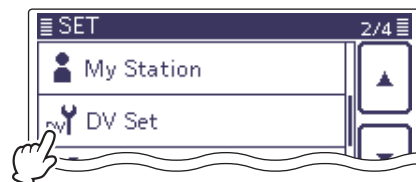

Touch "DV Set"

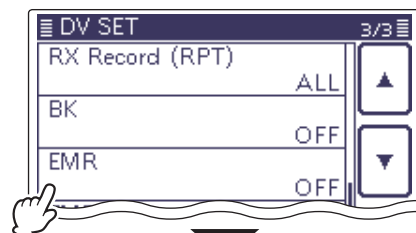

Touch "EMR"



Touch "ON"

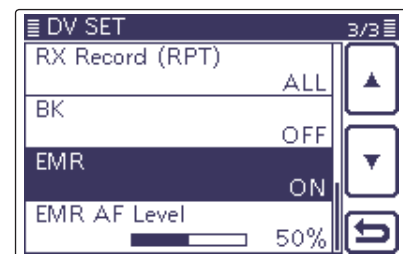

Push **SET**

Appears

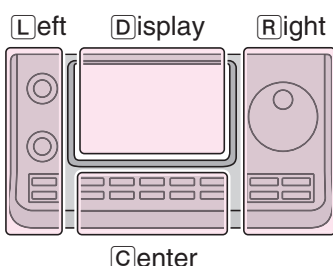

The **L**, **R**, **C** or **D** in the instructions indicate the part of the controller.

- L**: Left side
- R**: Right side
- C**: Center bottom
- D**: Display (Touch screen)

**EMR communication (Continued)**

**◇ Adjusting the EMR AF level**

The audio output level when an EMR signal is received is adjustable between 0 and 100.

When an EMR signal is received, the audio will be heard at the preset level, or the [AF] (L) control level, whichever is higher.

To disable the setting, set it to "0."

- ① Push **SET**(C) to enter the Set mode.
- ② Touch the "EMR AF Level" item of the DV SET Set mode.  
 DV Set > **EMR AF Level**
  - If the specified item is not displayed, touch [▲] or [▼](D) one or more times to select the page.
- ③ Touch [+] or [-](D) one or more times to adjust the EMR audio output level between 0 (minimum) and 100 (maximum) in single digit steps. (Default: 50)
- ④ Push **SET**(C) to exit the Set mode.

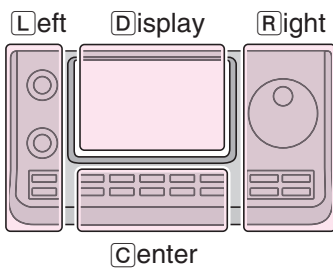

The L, R, C or D in the instructions indicate the part of the controller.

- L: Left side
- R: Right side
- C: Center bottom
- D: Display (Touch screen)

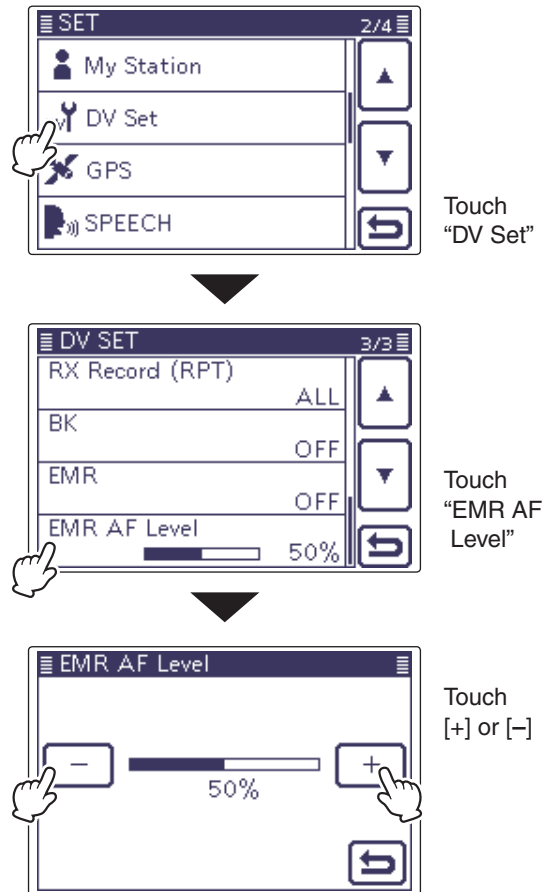

## Display type setting

The display size in the DR mode, such as a repeater name, **call sign**, and so on, can be set to Large.  
(Default: Normal)

- ① Push **QUICK**(**C**) to enter the Quick Set mode.
- ② Touch the "Display Type."
  - If the specified item is not displayed, touch **▲** or **▼**(**D**) one or more times to select the page.
- ③ Touch "Large."
  - The display size changes to the same size such as the repeater name set in "TO" and "FROM."

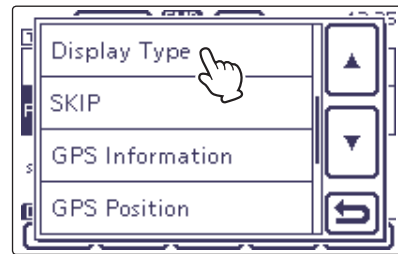

Touch "Display Type"



Touch "Large"

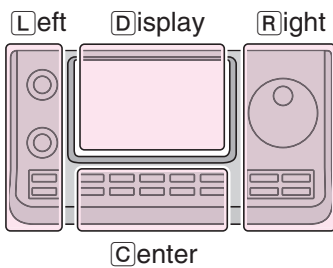

The **L**, **R**, **C** or **D** in the instructions indicate the part of the controller.

- L**: Left side
- R**: Right side
- C**: Center bottom
- D**: Display (Touch screen)

**C**enter

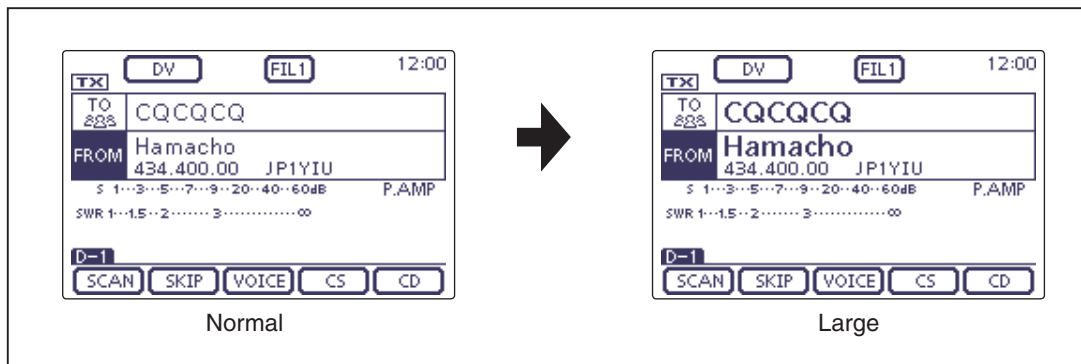



## DV automatic detection

If you receive an FM signal during DV mode operation, the “DV” and “FM” icons alternately blink to indicate the received signal is FM.

When the DV Auto Detect function is turned ON, the transceiver automatically selects the FM mode to temporarily monitor the signal. (Default: OFF)

• Regardless of this setting, the “DV” and “FM” icons alternately blink if you receive an FM signal during DV mode operation.

- ① Push **SET**(C) to enter the Set mode.
- ② Touch the “DV Auto Detect” item of the “DV Set” Set mode.  
 DV Set > **DV Auto Detect**
  - If the specified item is not displayed, touch [▲] or [▼](D) one or more times to select the page.
- ③ Touch “ON.”
- ④ Push **SET**(C) to exit the Set mode.
  - When an FM signal is received in the DV mode, the “DV” and “FM” icons sequentially blink, and the transceiver receives the signal in the FM mode.

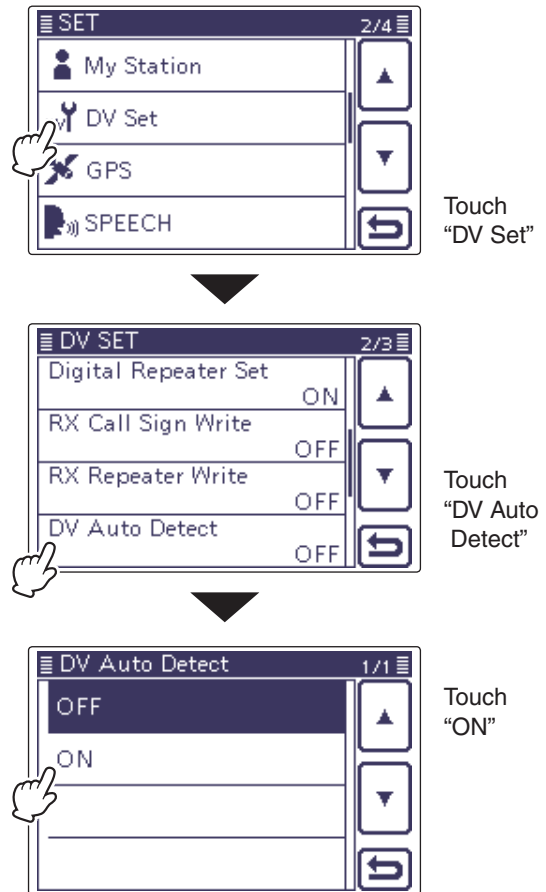

When digital call sign squelch (DSQL) or digital code squelch (CSQL) is selected, the transceiver does not receive FM signals, even if this function is ON. You can silently wait for calls from others.

### <When an FM signal is received while in the DV mode>

• DV Auto Detect function: OFF  
 The “DV” and “FM” icons sequentially blink, but the audio cannot be heard.

• DV Auto Detect function: ON  
 The “DV” and “FM” icons sequentially blink, and the audio can be heard.

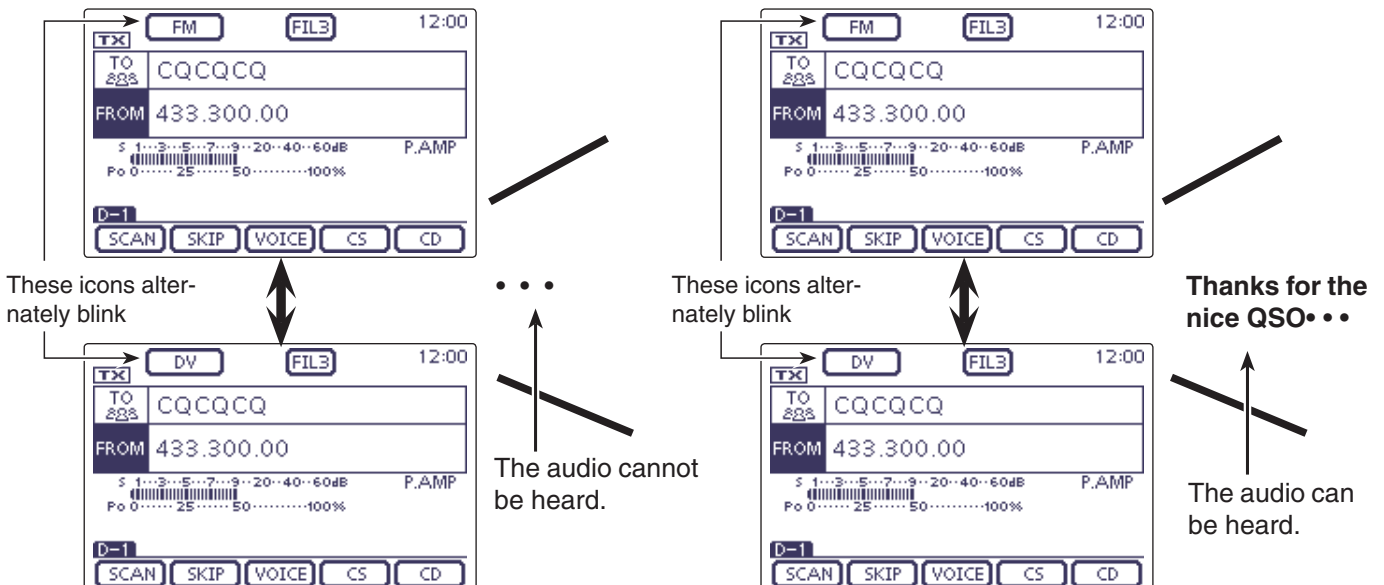

## Automatic Reply function

When a call addressed to your own **call sign** is received, the Automatic Reply function automatically replies with your call sign. (Default: OFF)

Depending on the setting, the recorded message may be transmitted with the call sign.

- 1 Push **SET**(C) to enter the Set mode.
- 2 Touch the "Auto Reply" item of the "DV Set" Set mode.

### DV Set > **Auto Reply**

- If the specified item is not displayed, touch [**▲**] or [**▼**](D) one or more times to select the page.

- 3 Touch the desired item to select "ON" or "Voice."

- ON: Replies with your own call sign. (No audio reply is sent)
- Voice: Replies with your call sign and any Auto Reply message recorded on the SD (up to 10 seconds).  
If no SD card is inserted or no message is recorded, only your call sign is transmitted.  
The transmitted audio can be monitored.

- 4 Push **SET**(C) to exit the Set mode.

### NOTE:

- When "ON" or "Voice" is selected, the Automatic Reply function is automatically turned OFF, when you push [PTT].

### To record the voice signal

You can record a voice announcement for the Auto Reply function in "DV Auto Reply" on the Set mode. (p. 17-12)

**SET**(C) > Voice Memo > **DV Auto Reply**

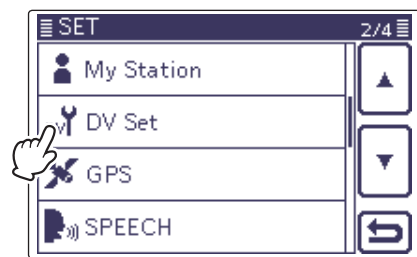

Touch "DV Set"

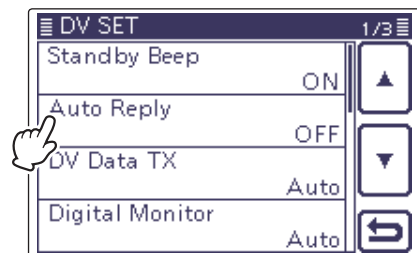

Touch "Auto Reply"

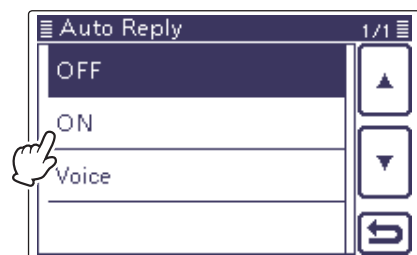

Touch "ON"

Push **SET**



Appears

After receiving a call from "JG3LUK," the transceiver automatically sends a reply call.

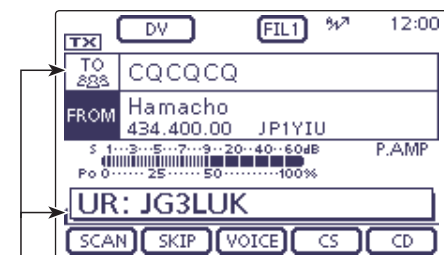

"TO" setting does not change, but "UR: JG3LUK (Caller's call sign)" is displayed.

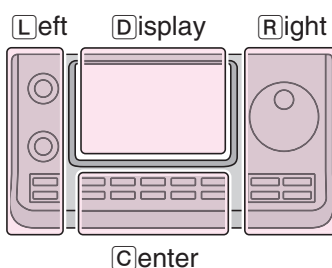

The L, R, C or D in the instructions indicate the part of the controller.

- L: Left side
- R: Right side
- C: Center bottom
- D: Display (Touch screen)

**Automatic Reply function (Continued)**

**◇ Recording an Auto Reply voice announcement**

The Auto Reply voice announcement can be recorded and saved on the SD card to reply to the call with your voice.

**NOTE:** Be sure to insert an SD card to the [SD] slot of the transceiver before starting to record a voice announcement.

- ① Push **SET**(C) to enter the Set mode.
- ② Touch the “DV Auto Reply” item of the “Voice Memo” Set mode.  
 Voice Memo > **DV Auto Reply**
  - If the specified item is not displayed, touch [▲] or [▼](D) one or more times to select the page.
- ③ Push [PTT] on the microphone to start recording. (No RF is transmitted)
  - After releasing [PTT] on the microphone, the recording is cancelled.
  - Maximum record period is 10 second
  - Hold the microphone 5 to 10 cm (2 to 4 inches) from your mouth, then speak into the microphone at a normal voice level.
  - Only one announcement can be recorded. The current contents will be overwritten if you record again.
- ④ Push **SET**(C) to exit the Set mode.

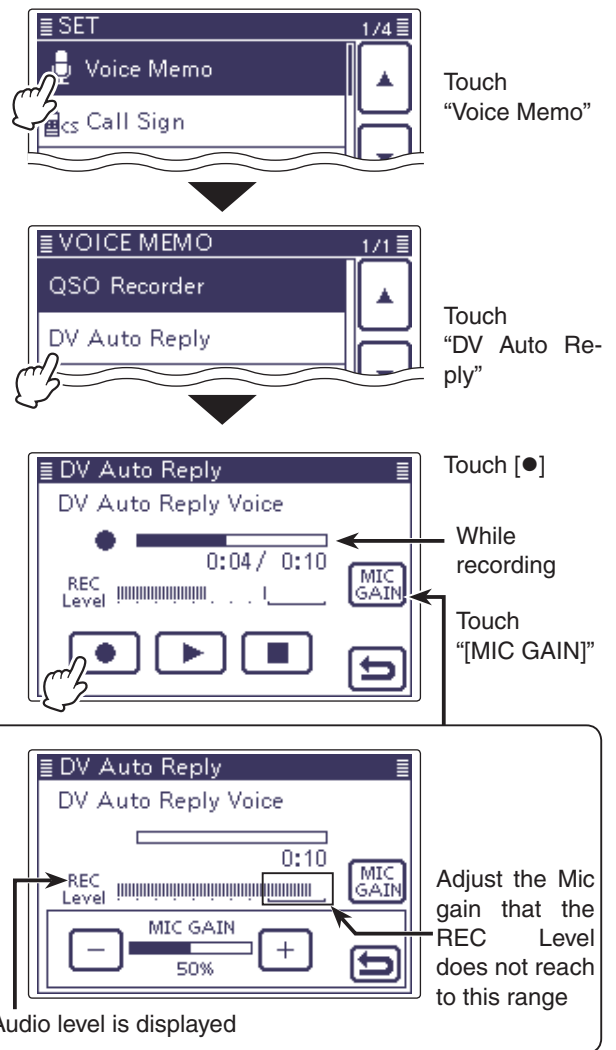

**◇ Playing back the recorded voice audio**

The recorded voice audio for the Auto Reply function can be played back.

- ① Push **SET**(C) to enter the Set mode.
- ② Touch the “DV Auto Reply” item of the “Voice Memo” Set mode.  
 Voice Memo > **DV Auto Reply**
  - If the specified item is not displayed, touch [▲] or [▼](D) one or more times to select the page.
- ③ Touch the [▶](D) to start the playback.
- ④ Push **SET**(C) to exit the Set mode.

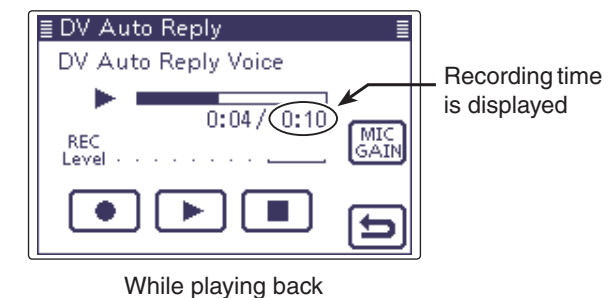

**✓ Information**

You can delete the recorded audio.

- On the DV AUTO REPLY screen, push **QUICK**(C), and then touch the “Clear.”

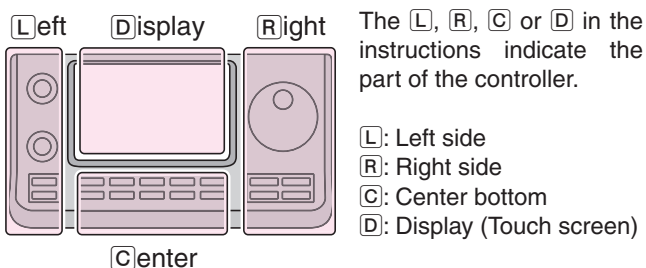
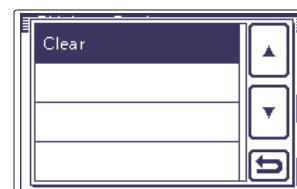

Automatic Reply function (Continued)

◇ Received Auto Reply Position Data

When you transmit a call to a destination station, but the station is in a situation that makes it difficult to operate the transceiver, the Auto Position Reply function automatically replies with its own **call sign** and the position.

After receiving the Auto Position Reply call, the screen shows the destination station's position.

The **D-STAR** product other than the IC-7100 do not reply the position after receiving a call.

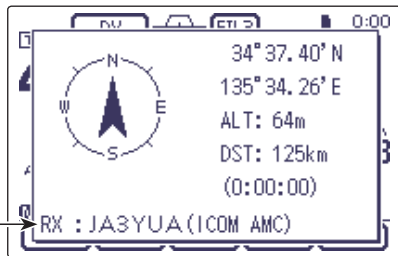

Scrolls a station call sign or the RX message

- The destination station must be set the GPS Auto TX setting (DV-G or DV-A) and the Auto Position reply setting

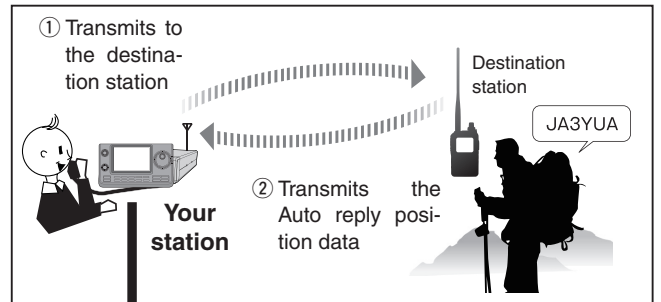

Transceiver can display the Distance and direction when the "GPS Select" item in the "GPS" Set mode is set to "External GPS" and the transceiver received position data from the external GPS, or the "GPS Select" item is set to "Manual." (p. 10-2)

**SET(C)** > GPS > GPS Set > **GPS Select**

## Low-speed data communication

In addition to digital voice communication, low-speed data communication can be made. Use the supplied USB cable or the optional OPC-1529R DATA COMMUNICATION CABLE with a third-party serial data communication software.

### ◇ Connection

Connect the transceiver to your PC using the USB cable or the OPC-1529R cable, as illustrated below.

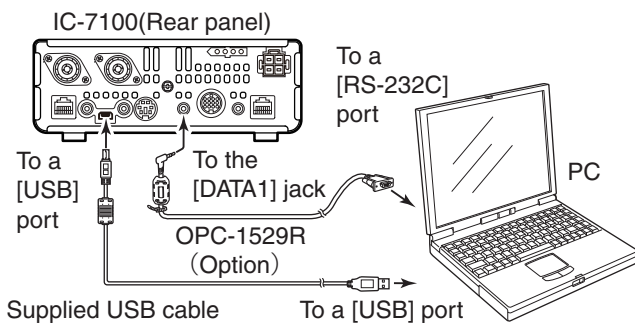

### Before starting low-speed data communication:

The “DV Data TX” item is set to “Auto” by default. So, depending on the data communication application software, the transceiver may automatically transmit the data only when you input text on the software screen.

**NOTE:** Before starting, be sure to set the Set mode items;

- Set the “GPS Out” option to “OFF”. (p. 17-25)  
Connectors > USB2/DATA1 Function > **GPS Out**
- Set the “GPS TX Mode” option to “OFF”. (p. 10-16)  
GPS > **GPS TX Mode**

### Connect the USB cable

- Set the “USB2 Function” option to “DV Data”. (p. 17-25)  
Connectors > USB2/DATA1 Function > **USB2 Function**

### Connect the OPC-1529R cable

- Set the “DATA1 Function” option to “DV Data”. (p. 17-25)  
Connectors > USB2/DATA1 Function > **DATA1 Function**

### ◇ Low-speed data communication application setting

Configure the serial data communication software as follows.

- Port: The COM port number which is used by the IC-7100.\*1
- Baud rate: 4800/9600 bps\*2
- Data: 8 bit
- Parity: None
- Stop: 1 bit
- Flow control: Xon/Xoff

\*1 Depending on the PC environment, the COM port number used by the IC-7100 may be higher than 5. In such case, use the application that can set it to higher than 5.

\*2 The baud rate can be set in the “DV Data/GPS Out Baud” item of the Set mode. (p. 17-26)  
**SET(C)** > Connectors > USB2/DATA1 Function > **DV Data/ GPS Out Baud**

### ◇ Low-speed data communication operation

- ① Set your own **call sign**, UR call sign and the repeater call sign.
- ② Follow the instructions of the data communication application software.
- ③ When data is input from a PC, the transceiver automatically transmits it.
  - The TX/RX indicator lights red.
  - Push [PTT] to transmit the data and a voice signal when “PTT” is selected in the “DV Data TX” item of the Set mode. (p. 17-13)  
**SET(C)** > DV Set > **DV Data TX**
  - Before transmission, the transceiver sends approximately 500 milliseconds carrier sense.

### NOTE:

- Only ASCII code can be used for the low-speed data communication.
- A message of up to 20 characters can be transmitted with a DV voice signal.
- Depending on the combination of your PC and your serial data communication software, some data may be lost.
- While receiving voice communication or low-speed data communication through the internet, some packets may be lost due to network error (poor data throughput performance). In such a case, “L” appears on the LCD to show the Packet Loss has occurred.

## Speech function

The speech function announces the called station **call sign**, or the individual or station call sign that is selected from the RX History.

It is convenient when you cannot watch the LCD, or you missed the call's audio.

This function helps you to know the call sign of the caller station without seeing the LCD.

### ◆ To announce the received call sign

The received call sign can be announced.

- ① Push **SET**(**C**) to enter the Set mode.
- ② Touch the "RX Call Sign SPEECH" item of the "SPEECH" Set mode.  
**SPEECH > RX Call Sign SPEECH**
  - If the specified item is not displayed, touch [**▲**] or [**▼**](**D**) one or more times to select the page.
- ③ Touch the desired item to select "ON (Kerchunk)" or "ON (All)."  
  - ON (Kerchunk): When a DV call is received, and if the call time is short, the calling station's call sign is announced. (Default)
  - ON (All): When a DV call is received, the calling station's call sign is announced.
- ④ Push **SET**(**C**) to exit the Set mode.  
  - When a DV call is received, the standby beep sounds, and after approximately 1 second, the call sign is announced.

#### NOTE:

- Even if a "/" and a note are after a call sign, they are not announced.
- The announced contents cannot be recorded on the SD card.

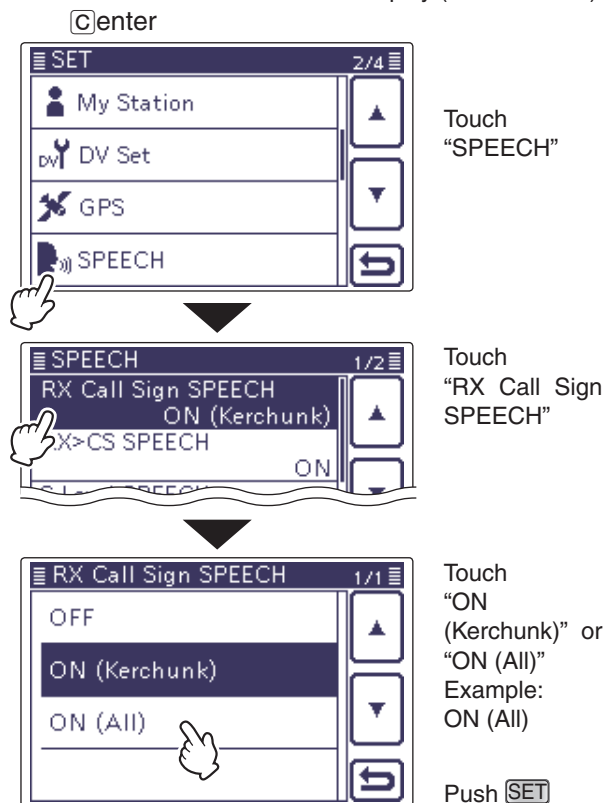
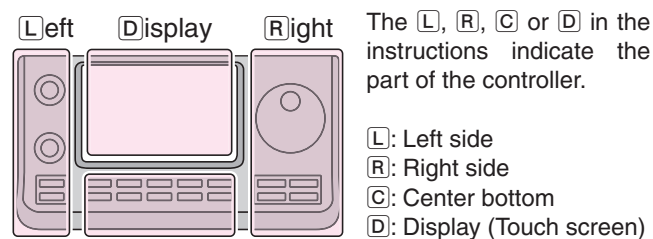

#### • When "ON (Kerchunk)" is selected

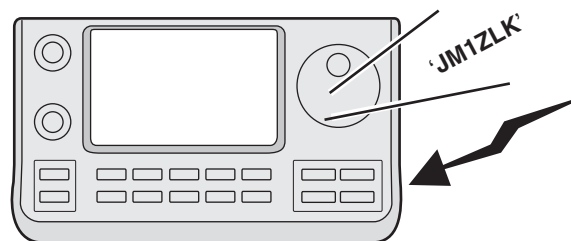

#### • When "ON (All)" is selected

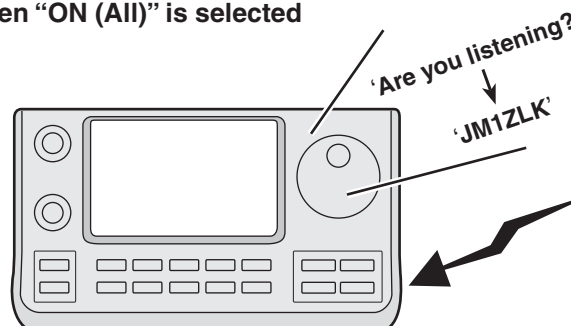

• The IC-7100 has other Speech functions:

**S-Level speech function**  
 The S-meter level is announced before the frequency and mode is announced by pushing **SPEECH**(**C**) (**SET**(**C**) > **SPEECH** > **S-Level SPEECH**)

**Mode speech function**  
 The selected operating mode is announced when mode is selected. (**SET**(**C**) > **SPEECH** > **MODE SPEECH**)

• When the digital squelch function is used, and if a received signal is not addressed to your call sign, or does not include an unmatched digital code, the calling station's call sign is not announced.

Speech function (Continued)

◆ To announce the RX>CS call sign

The station call sign that is selected from the RX History by holding down **AUTO TUNE(RX>CS)**(R), will be announced.

- ① Push **SET**(C) to enter the Set mode.
- ② Touch the "RX>CS SPEECH" item of the "SPEECH" Set mode.  
 SPEECH > **RX>CS SPEECH**
  - If the specified item is not displayed, touch **[▲]** or **[▼]**(D) one or more times to select the page.
- ③ Touch "ON." (Default: ON)
- ④ Push **SET**(C) to exit the Set mode.
- ⑤ Push **AUTO TUNE(RX>CS)**(R), touch to select the station call sign.
  - If the station call sign is not displayed, touch **[▲]** or **[▼]**(D) one or more times to select the page.
  - After releasing **AUTO TUNE(RX>CS)**(R), the selected station call sign is announced.

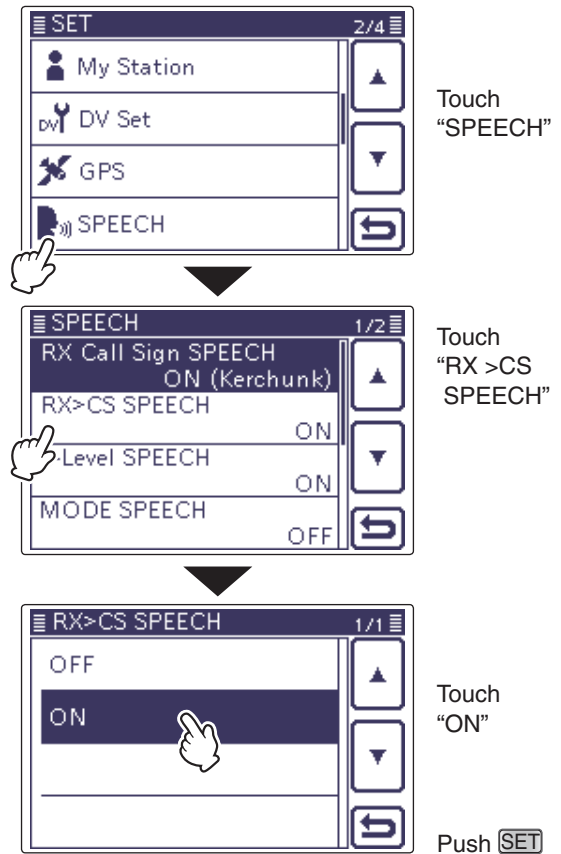

• When "ON" is selected

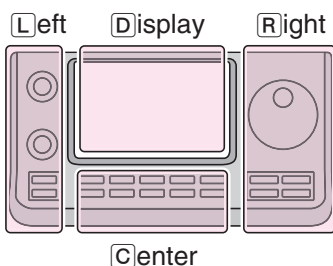
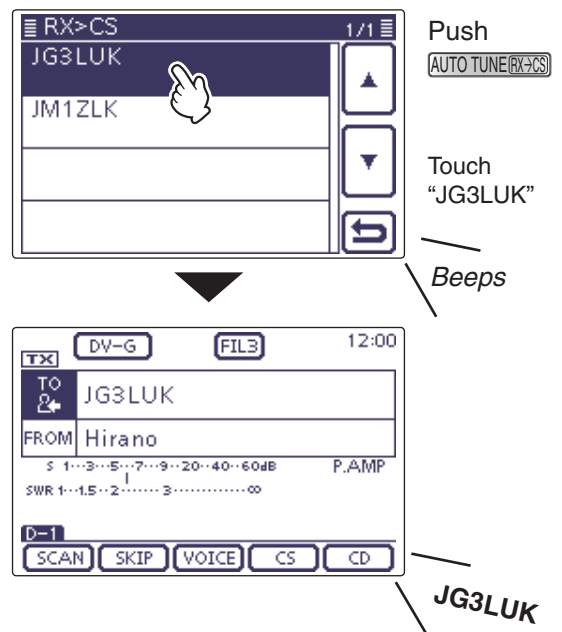

The L, R, C or D in the instructions indicate the part of the controller.

- L: Left side
- R: Right side
- C: Center bottom
- D: Display (Touch screen)



Speech function (Continued)

◇ **Speech Language selection**

The speech language can be set to English or Japanese.

This setting is used for all Speech functions.

- ① Push **SET**(**C**) to enter the Set mode.
- ② Touch the “SPEECH Language” item of the “SPEECH” Set mode.  
 SPEECH > **SPEECH Language**
  - If the specified item is not displayed, touch [**▲**] or [**▼**](**D**) one or more times to select the page.
- ③ Touch “English” or “Japanese.”  
 (Default: English)
- ④ Push **SET**(**C**) to exit the Set mode.
  - A **call sign** is announced in the selected language.

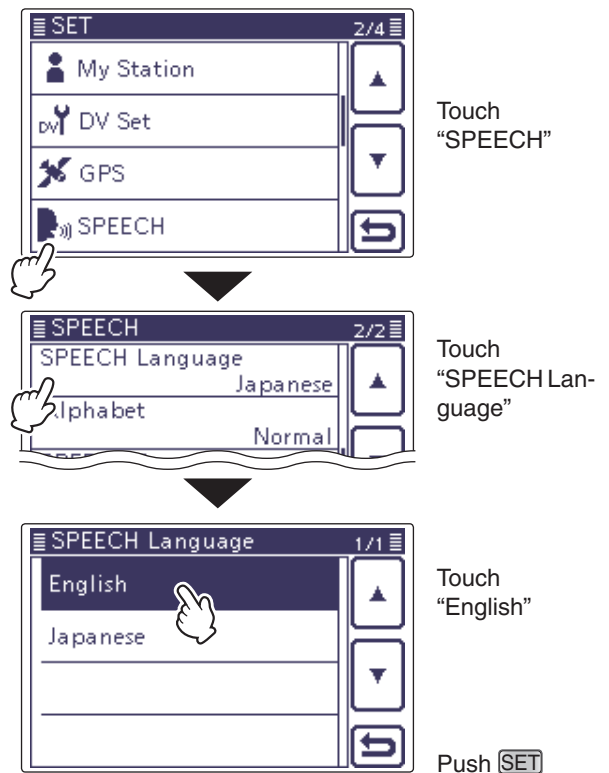

◇ **Phonetic Code setting for the Speech alphabet character**

The speech alphabet character can be set to phonetic code.

This setting is used for all Speech functions.

- ① Push **SET**(**C**) to enter the Set mode.
- ② Touch the “Alphabet” item of the “SPEECH” Set mode.  
 SPEECH > **Alphabet**
  - If the specified item is not displayed, touch [**▲**] or [**▼**](**D**) one or more times to select the page.
- ③ Touch “Phonetic Code.”
- ④ Push **SET**(**C**) to exit the Set mode.

• When “Phonetic Code” is selected

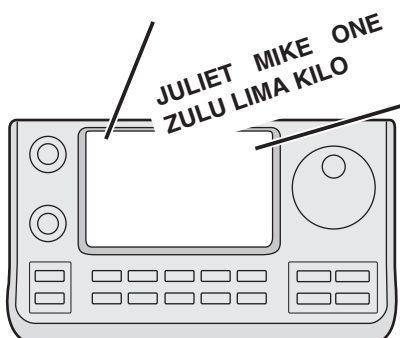

Example: JM1ZLK

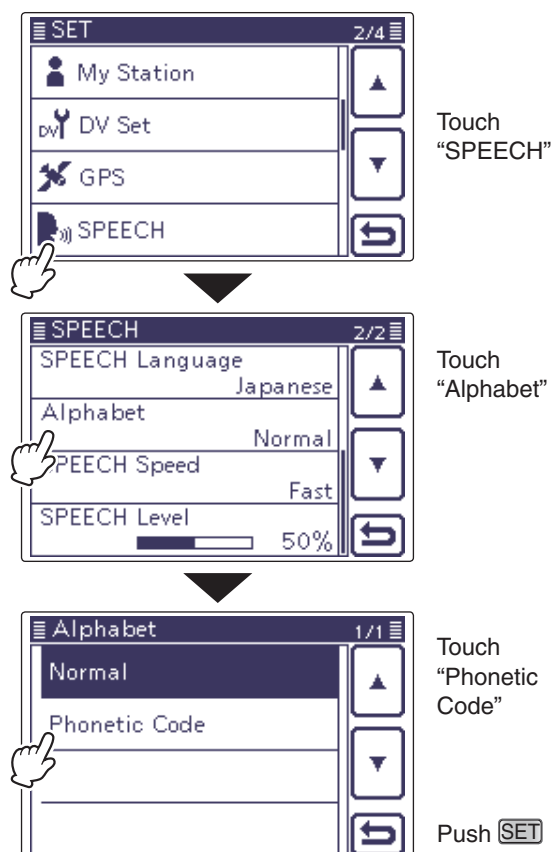

Speech function (Continued)

◇ **Speech speed selection**

The speech speed can be set to slow or fast. This setting is used for all Speech functions.

- ① Push **SET**(**C**) to enter the Set mode.
- ② Touch the "SPEECH Speed" item of the "SPEECH" Set mode.  
SPEECH > **SPEECH Speed**
  - If the specified item is not displayed, touch [**▲**] or [**▼**](**D**) one or more times to select the page.
- ③ Touch "Slow" or "Fast."  
(Default: Fast)
- ④ Push **SET**(**C**) to exit the Set mode.

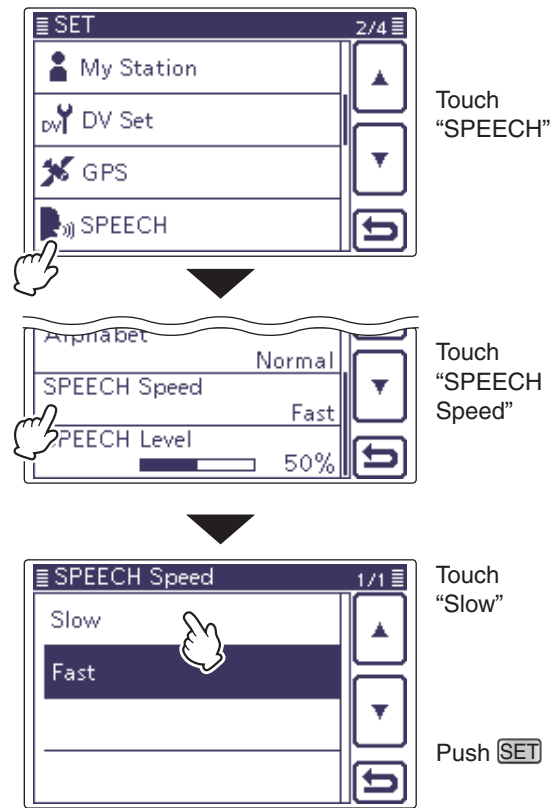

◇ **Speech level selection**

The speech volume level can be set to between 0% (minimum) and 100% (maximum). This setting is used for all Speech functions.

- ① Push **SET**(**C**) to enter the Set mode.
- ② Touch the "SPEECH Level" item of the "SPEECH" Set mode.  
SPEECH > **SPEECH Level**
  - If the specified item is not displayed, touch [**▲**] or [**▼**](**D**) one or more times to select the page.
- ③ Touch [**+**] or [**-**](**D**) one or more times to set the speech volume level to between 0% (minimum) and 100% (maximum) in single digit steps. (Default: 50%)
- ④ Push **SET**(**C**) to exit the Set mode.
  - When "0" (minimum) is selected, the **call sign** won't be announced.
  - The volume level can be adjusted with the **[AF]**(**L**) control.

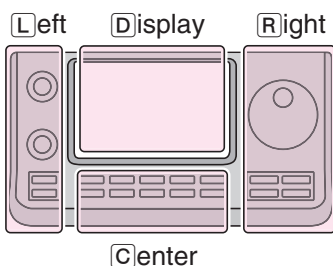
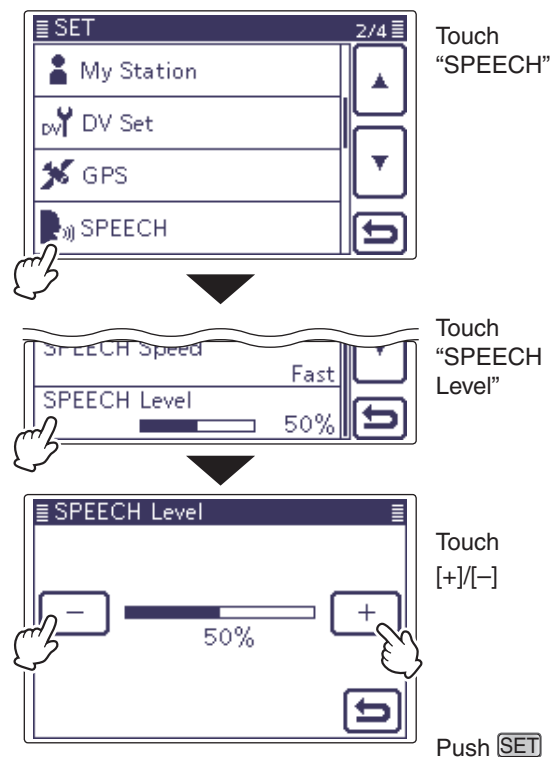

The **L**, **R**, **C** or **D** in the instructions indicate the part of the controller.

- L**: Left side
- R**: Right side
- C**: Center bottom
- D**: Display (Touch screen)

## Digital squelch functions

The digital squelch opens only when receiving a signal addressed to your own **call sign**, or a signal that includes a matching digital code.

You can silently wait for calls from others.

You can independently set the Digital squelch function in the VFO, Memory, CALL channel, or DR modes.

### ◆ The digital call sign squelch setting

- ① Push **[DR]**(**C**) to enter the DR mode.
- ② Push **[MENU]**(**C**) to select the “D-2” screen (D-2 menu).
  - To use the digital call sign squelch function in another mode, push **[MENU]**(**C**) to select the “M-2” screen (M-2 menu).
- ③ Touch **[DSQL]**(**D**) one or more times to set the digital call sign squelch ON, the digital code squelch ON or OFF.
  - “DSQL” appears when the digital call sign squelch is ON.
- ④ When the received signal includes a matching call sign, the squelch opens and the audio is heard.
  - When the received signal’s call sign does not match, digital call sign squelch does not open; however, the S/RF meter shows the received signal level.

**NOTE:**

- **DO NOT** use the digital code squelch function when communicating with two or more stations, because the digital call sign squelch function opens only when receiving a signal addressed to your own call sign. Thus the digital call sign squelch function can be used when communicating with only one station.
- While operating in the low-speed data communication mode, the digital squelch opens even if receiving a signal is not addressed to your own call sign.

### ◆ The digital code squelch setting

- ① Push **[DR]**(**C**) to enter the DR mode.
- ② Push **[MENU]**(**C**) to select the “D-2” screen (D-2 menu).
  - To use the digital code squelch function in another mode, push **[MENU]**(**C**) to select the “M-2” screen (M-2 menu).
- ③ Touch **[DSQL]**(**D**) one or more times to set the digital call sign squelch ON, the digital code squelch ON or OFF.
  - “CSQL” appears when the digital code squelch is ON.
- ④ When the received signal includes a matching code, the squelch opens and the audio is heard.
  - When the received signal’s code does not match, the digital code squelch does not open; however, the S/RF meter shows the received signal strength.

- NOTE:** While operating in the low-speed data communication mode, the digital code squelch opens even if receiving a signal does not match to your digital code.

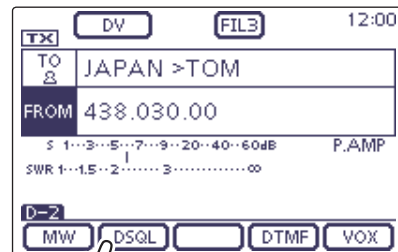

Touch [DSQL] one or more times.

Appears

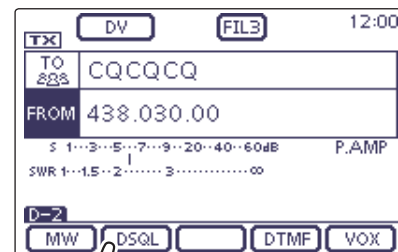
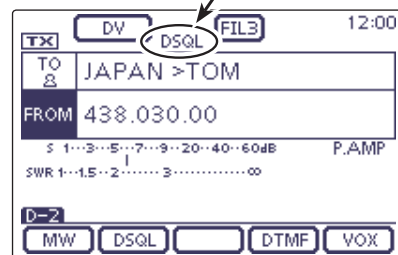

Touch [DSQL] one or more times.

Appears

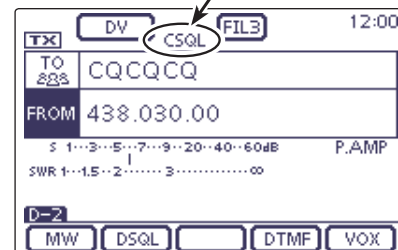

Digital squelch function (Continued)

◆ Digital code setting

- ① Push [DR](C) to enter the DR mode.
- ② Push [MENU](C) to select the “D-2” screen (D-2 menu).
  - To use the digital code squelch function in another mode, push [MENU](C) to select the “M-2” screen (M-2 menu).
- ③ Touch [DSQL](D) for 1 second to display the “DSQL” screen.
- ④ Rotate the Dial to adjust the digital code.
  - If desired, touch [DEF](D) for 1 second to reset to the default setting.
  - When the received signal’s code does not match, the digital code squelch does not open; however, the S/RF meter shows the received signal strength.

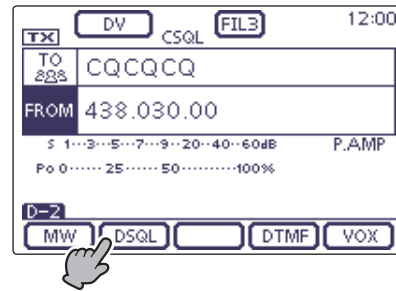

Touch [DSQL] for 1 second.

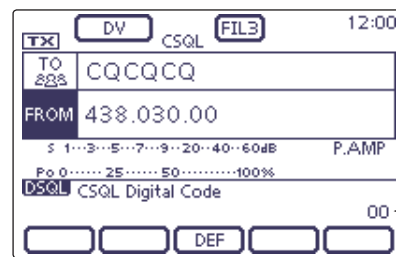

Rotate the Dial.

A total of 100 codes (00–99) are selectable.

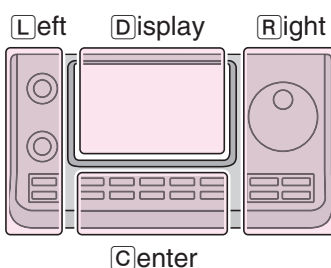

The L, R, C or D in the instructions indicate the part of the controller.

- [L]: Left side
- [R]: Right side
- [C]: Center bottom
- [D]: Display (Touch screen)

## Viewing the call signs

The **Call sign** can be displayed or change in the in the “Call Sign” Set mode.

**SET**(C) > **Call sign**

While in the DV mode, shows the “CALL SIGN” screen in the “D-1” screen (D-1 menu).

- ① Push **DR**(C) to enter the DR mode.
- ② Push **MENU**(C) to select the “D-1” screen (D-1 menu).
  - To use the Call sign setting in another mode, push **MENU**(C) to select the “M-2” screen (M-2 menu).
  - The CALL SIGN screen can be displayed in the DR, VFO, Memory or Call channel modes.
- ③ Touch **[CS]**(D).
- “CALL SIGN” screen appears.
- ④ Push **MENU**(C) to exit the “CALL SIGN” screen.

While in the DR mode



Touch [CS].

Access repeater call sign

Destination call sign

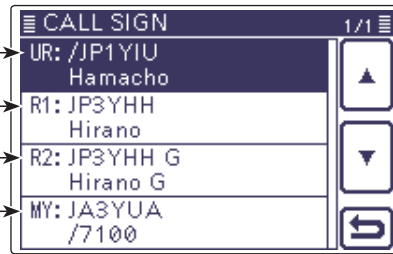

Your own call sign

Gateway repeater call sign

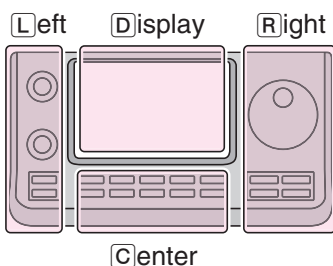

The **L**, **R**, **C** or **D** in the instructions indicate the part of the controller.

- L**: Left side
- R**: Right side
- C**: Center bottom
- D**: Display (Touch screen)

## Changing the Call sign setting

Sets or displays the “UR,” “R1,” “R2” and “MY” call signs to be used for DV operation.

Except for the DR mode, sets the desired call signs to be used for DV operation in this screen.

### ◇ Simplex operation

While in the Simplex operation, the “R1” and “R2” call signs cannot be set. And while in the DR mode, the “UR” call sign cannot be changed.

#### Example :

In this content explains that is operating in the memory mode, and changing the “UR:” call sign.

- ① Select any other than DR mode.  
(Example: Memory mode)
- ② Push **MENU**(C) one or more times to select the “M-2” screen (M-2 menu).
- ③ Touch **[CS]**(D) to enter the “CALL SIGN” screen.
- ④ Touch “UR:” or “MY:.” (Example: UR: CQCQCQ)
  - The “YOUR SELECT” screen is displayed.
  - In the simplex operation, the “R1:” or “R2:” cannot be selected.
- ⑤ Touch a desired selection. (Example: Your Call Sign)
  - The “YOUR CALL SIGN” screen is displayed.
- ⑥ Touch a desired station. (Example: ICOM 01)
  - The selected call sign is displayed in the “CALL SIGN” screen.
- ⑦ Push **MENU**(C) to exit the “CALL SIGN” screen.
- ⑧ If you want to memorize this setting, touch **[MW]**(D) for 1 second in the “M-1” screen (M-1 menu).

Example: When changing “UR:” in the 438.03 MHz, DV mode

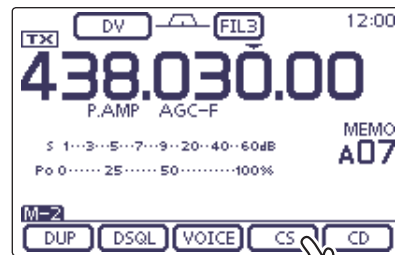

Touch [CS]

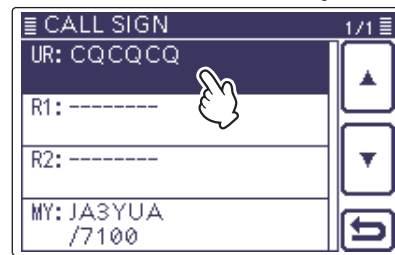

Touch the desired call sign to be changed (Example : UR:CQCQCQ)

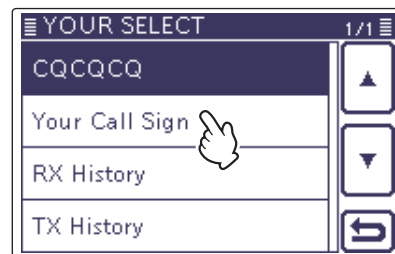

Touch the selection (Example: Your Call Sign)



Touch the station (Example: ICOM 01)

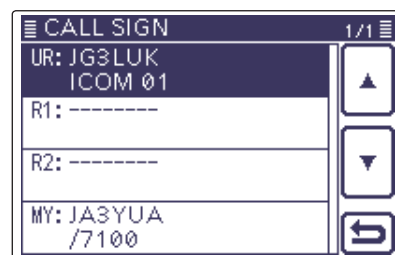

#### NOTE

In the “CALL SIGN” screen, touch “UR:” for 1 second to open the function window. The function window displays the “Edit,” “Clear” and “Add To Your Memory” items, and then touch the desired item.

- Touch “Edit” to enter the Call sign edit screen.
- Touch “Clear” to delete the “UR:” setting.
- Touch “Add To Your Memory” to enter the “YOUR CALL SIGN EDIT” screen.



**Changing the Call sign setting (Continued)**

**◇ For Duplex (repeater) operation**

While in the DR mode, only “MY” call sign can be set.

**Example :**

While in the DV mode, Making a Gateway call Making a gateway CQ call to Hamacho repeater (JP1Y-IU B) from the Hirano repeater (JP3YHH B)\*, while in the DV mode.

\*Before starting to set the call sign, set the frequency of your access repeater or duplex setting. (See Section 3.)

**1. Call sign “R1” setting**

- ① Select any other than DR mode. (Example: Memory mode)
- ② Push **[MENU]**(C) one or more times to select the “M-2” screen (M-2 menu).
- ③ Touch **[CS]**(D) to enter the “CALL SIGN” screen.
- ④ Touch “R1:” for 1 second.
  - The function window is displayed.
  - Rotate the Dial to select “R1:,” and then push **[QUICK]**(C) also opens the function window.
- ⑤ Touch “Edit” to enter the “RPT1 CALL SIGN” (Edit) screen.
- ⑥ Touch the desired block one or more times to select the desired character or symbol. (Example: J)

Selectable characters and symbols
A to Z, 0 to 9, /and (space)

- Touch “AB↔12” to toggle between the Alphabet input and Number input mode.
  - Touch **[CLR]**(D) to delete the selected character, symbol or number.
  - Touch “\_” to input a space.
- ⑦ Touch **[←]**(D) to move the cursor backwards, or touch **[→]**(D) to move the cursor forwards.
  - ⑧ Repeat steps ⑥ and ⑦ to enter up to 8 characters, including spaces, and then touch **[ENT]**(D). (Example: First, J, then P, then 3, then Y, then H, then H.)
    - The display returns to the “CALL SIGN” screen.

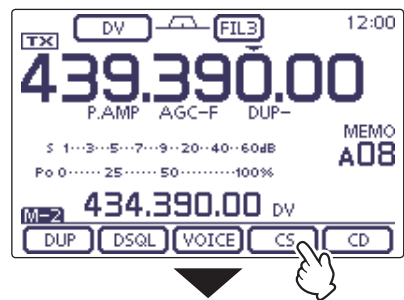

Touch [CS]

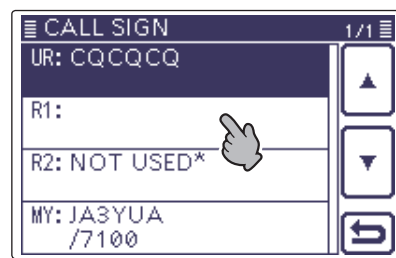

Touch “R1:” for 1 second

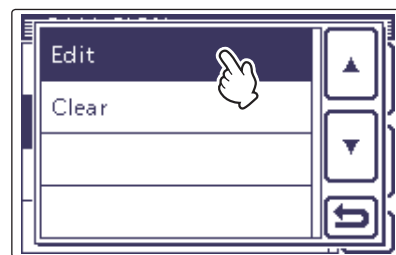

Touch “Edit”



Edit the Call sign, then touch [ENT].

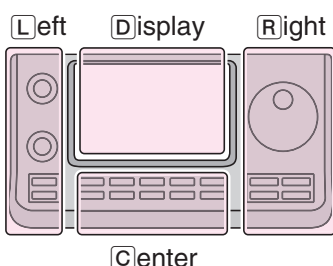
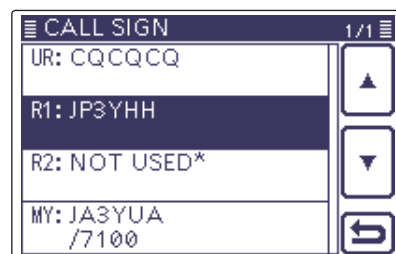

The L, R, C or D in the instructions indicate the part of the controller.

- L: Left side
- R: Right side
- C: Center bottom
- D: Display (Touch screen)



**Changing the Call sign setting (Continued)**

**2. Gateway “R2” setting**

- ⑨ Touch “R2:.”
  - The “RPT2 SELECT” screen is displayed.
- ⑩ Touch “GW.”
  - The display returns to the “CALL SIGN” screen.

• When you manually enter the call sign, touch “R2:” for 1 second in step ⑩.

NOT USED*	For local area call
GW	To select the gateway call sign from the repeater list.
Repeater name	To select the repeater that has the same gateway as the “R1”repeater.

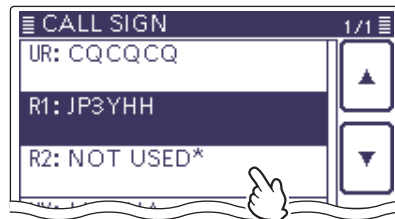

Touch “R2:”

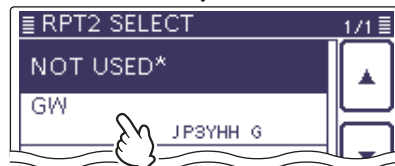

Touch “GW”

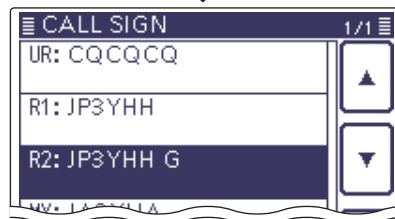

**3. Destination “UR” setting**

- ⑪ Touch “UR:.”
  - The “YOUR SELECT” screen is displayed.
- ⑫ Touch “Gateway CQ.”
  - The “REPEATER GROUP” screen is displayed.
- ⑬ Touch the desired Repeater group. (Example: USA Midwest)
  - The “RPT LIST GRP” screen is displayed.
- ⑭ Touch the desired Repeater. (Example: Dallas)
  - The display returns to the “CALL SIGN” screen.
- ⑮ Push **[MENU](C)** to exit the “CALL SIGN” screen.

• When you manually enter the call sign, touch “UR:” for 1 second in step ⑪.  
 • If you want to memorizes this setting, touch **[MW](D)** for 1 second in the “M-1” screen (M-1 menu).



Touch “UR:”



Touch “Gate-  
way CQ”

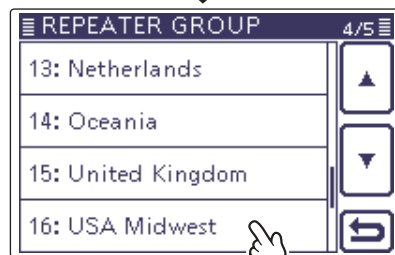

Touch “USA  
Midwest”



Touch  
“Dallas”

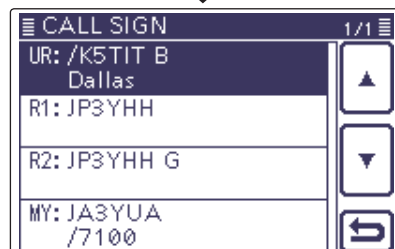

## Repeater list

You can store repeater information for quick and simple communication in up to 900 repeater memory channels (Repeater list) in up to 25 Groups. Programming the repeater list is required for DR mode operation.

**NOTE:** For easy operation, the repeater list is pre-loaded into your transceiver. However, if the CPU clears all programmed contents (All Reset), the repeater list is also cleared. We recommend that memory data be backed up externally or be saved to a PC using the optional CS-7100 CLONING SOFTWARE.

**About the repeater list:**

The repeater list can be downloaded from the Icom website.  
<http://www.icom.co.jp/world/support/download/firm/index.html>

### ◇ Repeater list contents

The following contents are included in the repeater list:

- NAME (Repeater name) (p. 9-30)
- SUB NAME (Repeater sub name) (p. 9-31)
- CALL SIGN (Repeater call sign and port letter) (p. 9-32)
- GW CALL SIGN (Gateway repeater's call sign and port "G") (p. 9-33)
- GROUP (Repeater group) (p. 9-33)
- USE(FROM) (Access repeater use) (p. 9-34)
- FREQUENCY (Access repeater's input frequency)\* (p. 9-34)
- DUP (Duplex direction)\* (p. 9-35)
- OFFSET FREQ (Frequency offset)\* (p. 9-35)
- POSITION (Position data accuracy level) (p. 9-36)
- LATITUDE (Latitude position of the repeater) (p. 9-36)
- LONGITUDE (Longitude position of the repeater) (p. 9-36)
- UTC OFFSET (UTC Offset) (p. 9-37)

\* Appears only when USE(FROM) is selected as YES.

**Example:** "Hirano" repeater information

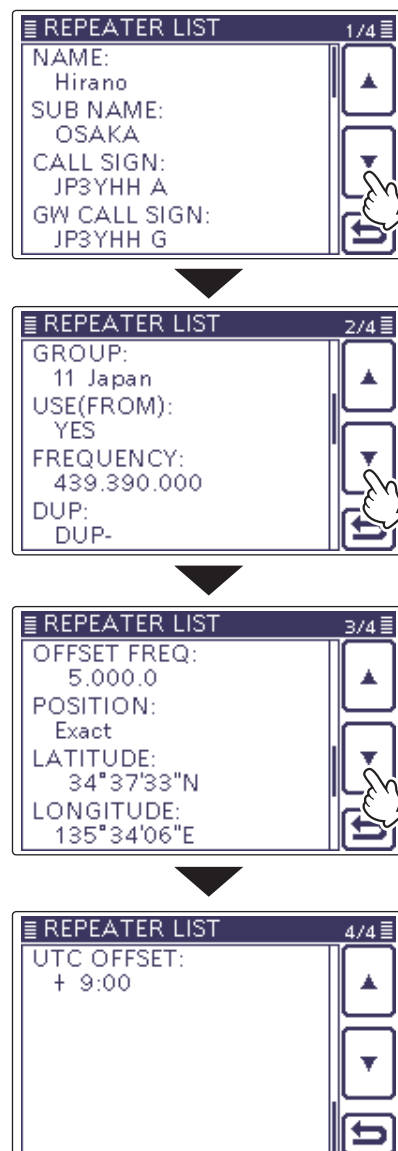

## Repeater list programming

This section describes how to manually program new repeater into the repeater list.

The required setting items differ, depending on the repeater use. Be sure to confirm the required items, as shown to the right.

**NOTE:** To program a repeater into the repeater list, the repeater's **call sign** MUST be entered.

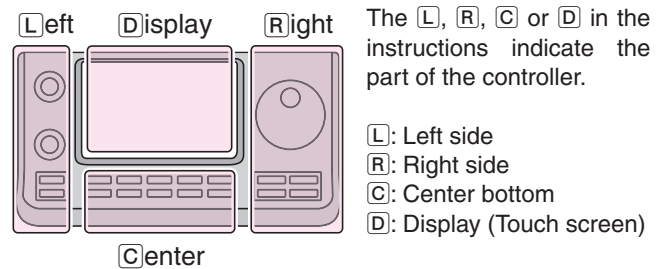

### Required items for the communication cases

Repeater list contents	Used as an access repeater	Used as a destination repeater	Used for a simplex communication
NAME	–	–	–
SUB NAME	–	–	–
CALL SIGN	✓	✓	This item MUST be blank.
GW CALL SIGN	✓ (For Gateway call)	✓	–
GROUP	–	–	–
USE(FROM)	✓	–	✓
FREQUENCY	✓	–	✓
DUP	✓	–	This item MUST be set to "OFF"
OFFSET FREQ	✓	–	–
POSITION	–	–	–
LATITUDE	–	–	–
LONGITUDE	–	–	–
UTC OFFSET	–	–	–

### New repeater programming

#### 1. Repeater group selection

- Push **SET**(**C**) to enter the Set mode.
- Touch the "Repeater List" item of the "DV Memory" Set mode.  
 DV Memory > **Repeater List**
  - If the specified item is not displayed, touch **▲** or **▼**(**D**) one or more times to select the page.
  - The repeater groups are displayed.
- Touch **▲** or **▼**(**D**) to select the desired repeater group to be programmed.
  - The repeater list of the selected repeater group is displayed.
- Push **QUICK**(**C**).
- Touch **[Add]**(**D**).
  - The "REPEATER LIST EDIT" screen is displayed.

\*When you want to add a new repeater by editing a programmed repeater memory contents, select "Edit." In this case, after programming, be sure to select "<<Add Write>>." If you select "<<Overwrite>>," the original repeater programmed contents are overwritten.

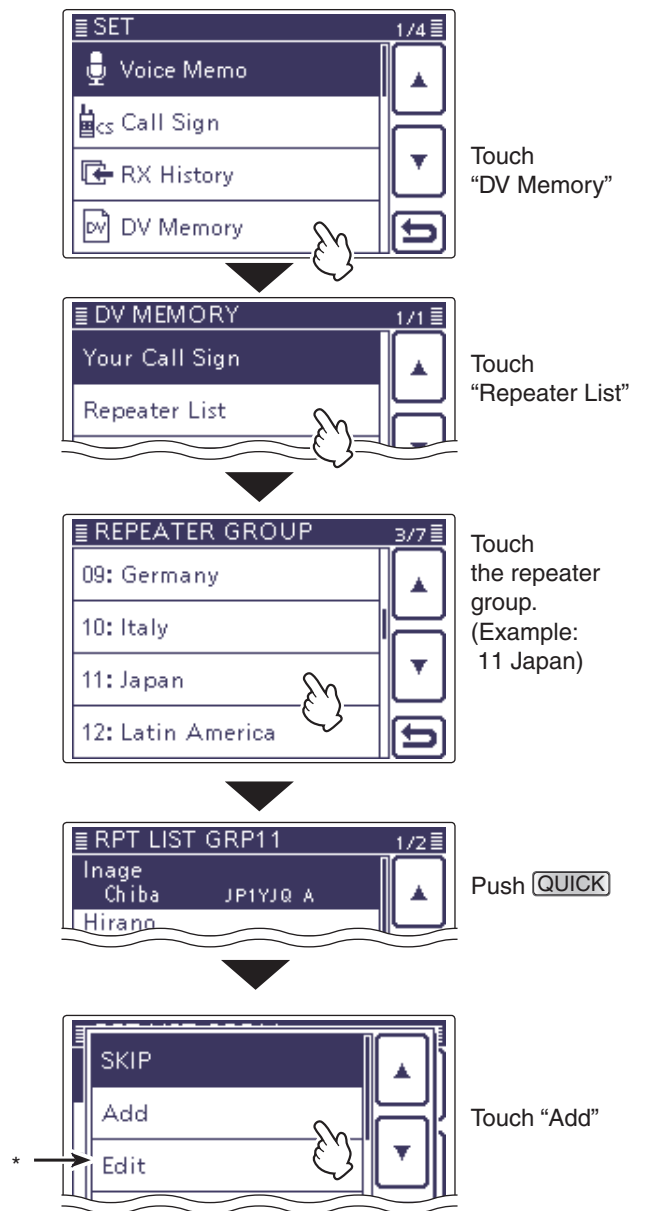

Continued on the next page.

**Repeater list programming (Continued)**

**2. Repeater name programming**

- ⑥ Touch "NAME" to enter the repeater name edit mode.
  - A cursor appears and blinks.
- ⑦ Touch the desired block one or more times to select the desired character or symbol.

Selectable characters and symbols
A to Z, a to z, 0 to 9, ! # \$ % & \ ? " ' ` ^
+ - * / . , : ; = < > ( ) [ ] { }   _ ` @ (space)

- Touch "AB↔12" to toggle between the Alphabet input and Number input mode.
- Touch [CLR](D) to delete the selected character, symbol or number.
- Touch [ [AB] ](D) to open the input mode selection window.
- Touch " \_ " to input a space.
- ⑧ Touch [←](D) to move the cursor backwards, or touch [→](D) to move the cursor forwards.
- ⑨ Repeat steps ⑦ and ⑧ to enter a name of up to 16 characters, including spaces.
- ⑩ After entering the name, touch [ENT](D).

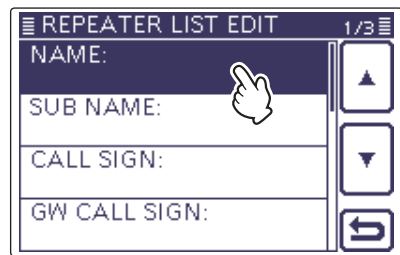

Touch "NAME"

**Name edit screen**

Move the cursor

Input mode selection window

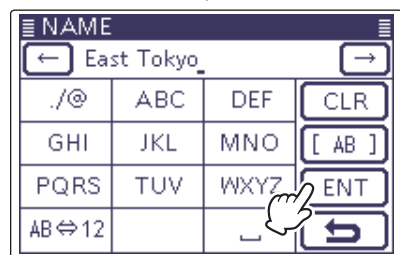

**Example:**  
"East Tokyo"

Touch [ENT]

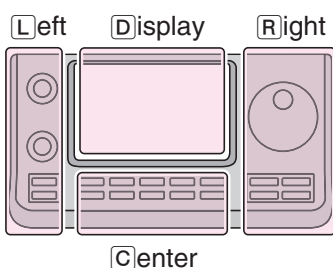

The L, R, C or D in the instructions indicate the part of the controller.

- L: Left side
- R: Right side
- C: Center bottom
- D: Display (Touch screen)

Continued on the next page.

Repeater list programming (Continued)

3. Repeater sub name programming

- ⑪ Touch "SUB NAME" to enter the repeater sub name edit mode.
  - A cursor appears and blinks.
- ⑫ Touch the desired block one or more times to select the desired character or symbol.

Selectable characters and symbols
A to Z, a to z, 0 to 9, ! # \$ % & \ ? " ' ` ^
+ - * / . , : ; = < > ( ) [ ] { }   _ ` @ (space)

- Touch "AB↔12" to toggle between the Alphabet input and Number input mode.
- Touch [CLR](D) to delete the selected character, symbol or number.
- Touch [ [AB] ](D) to open the Input mode selection window.
- Touch " " to input a space.
- ⑬ Touch [←](D) to move the cursor backwards, or touch [→](D) to move the cursor forwards.
- ⑭ Repeat steps ⑫ and ⑬ to enter a sub name of up to 8 characters, including spaces.
- ⑮ After entering the name, touch [ENT](D).



Touch "SUB NAME"

Sub name edit screen

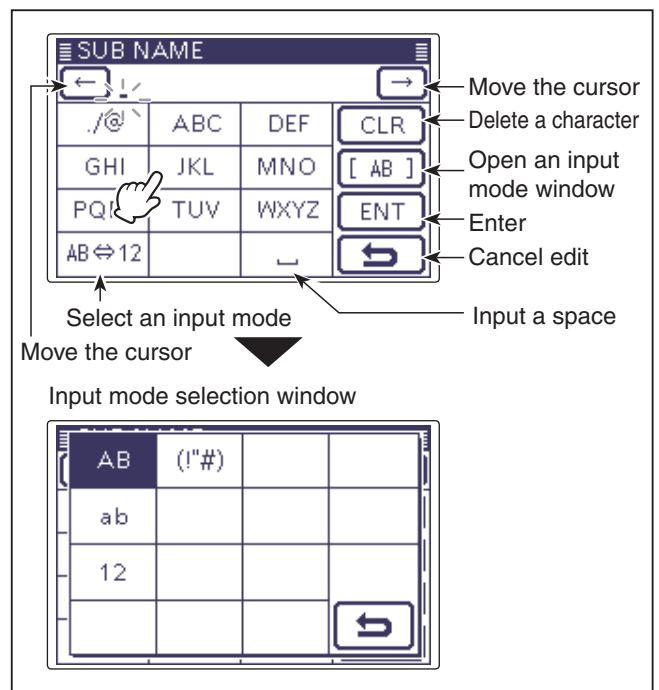

Move the cursor

Input mode selection window

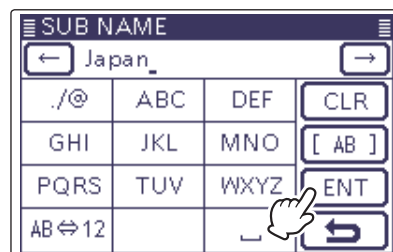
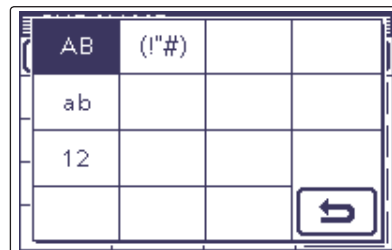

Example: "Japan"

Touch [ENT]

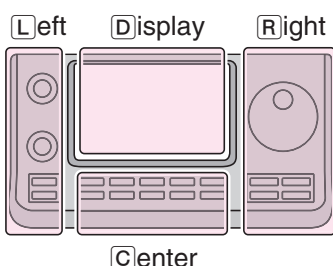

The L, R, C or D in the instructions indicate the part of the controller.

- L: Left side
- R: Right side
- C: Center bottom
- D: Display (Touch screen)

Continued on the next page.

Repeater list programming (Continued)

4. Repeater call sign programming

When used for simplex communication, go to [7. Access repeater setting].

- ⑩ Touch "CALL SIGN" to enter the repeater call sign edit mode.
  - A cursor appears and blinks.
- ⑪ Touch the desired block one or more times to select the desired character or symbol.
  - A to Z, 0 to 9, / and a space can be selected.
  - Touch "AB↔12" to toggle between the Alphabet input and Number input mode.
  - Touch [CLR](D) to delete the selected character, symbol or number.
  - Touch " " to input a space.
- ⑫ Touch [←](D) to move the cursor backwards, or touch [→](D) to move the cursor forwards.
- ⑬ Repeat steps ⑪ and ⑫ to enter a call sign of up to 8 characters, including spaces.
- ⑭ After entering the call sign, touch [ENT](D).

✓ Information

Be sure to add a repeater node (port) letter as the 8th digit in the call sign field after a repeater call sign, according to the repeater frequency band, as shown below.

- Note that Japanese repeater node letters are different.
- 1200 MHz: A (B in Japan)
- 430 MHz: B (A in Japan)
- 144 MHz: C (no **D-STAR** repeaters in Japan)

Cross band operation between different nodes at the same repeater site can be made.



Touch "CALL SIGN"

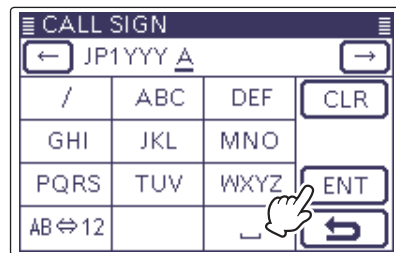

Example: "JP1YYY A"

Touch [ENT]

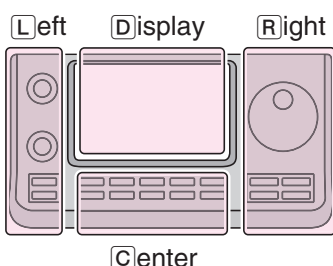

The L, R, C or D in the instructions indicate the part of the controller.

- L: Left side
- R: Right side
- C: Center bottom
- D: Display (Touch screen)

Continued on the next page.

Repeater list programming (Continued)

5. Gateway repeater call sign programming

The 8th digit in the call sign, programmed in '4. Repeater call sign programming' as described above, is automatically set to "G" as the gateway port. And you can skip this setting and go to the next item. If you need to change it, follow the steps, as described below.

- ① Touch "GW CALL SIGN" to enter the gateway repeater call sign edit mode.
  - A cursor appears and blinks.
- ② Touch the desired block one or more times to select the desired character or symbol.
  - A to Z, 0 to 9, / and a space can be selected.
  - Touch "AB↔12" to toggle between the Alphabet input and Number input mode.
  - Touch [CLR](D) to delete the selected character, symbol or number.
  - Touch " " to input a space.
- ③ Touch [←](D) to move the cursor backwards, or touch [→](D) to move the cursor forwards.
- ④ Repeat steps ② and ③ to enter a call sign of up to 8 characters, including spaces.
  - The 8th digit in the gateway repeater call sign is set to only "G" or a space.
- ⑤ After entering the gateway repeater call sign, touch [ENT](D).



Touch "GW CALL SIGN"

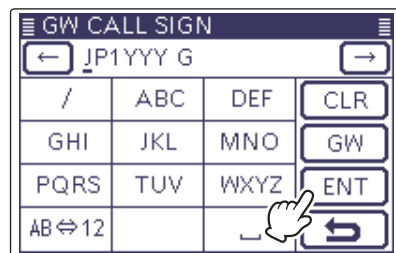

Example: "JP1YYY G"

Touch [ENT]

6. Repeater group viewing

In this item, you can view the repeater group that is selected in [1. Repeater group selection]. And you can skip this setting and go to the next item. If necessary, you can change the repeater group.

- ⑥ Touch [▼](D).
- ⑦ Touch "GROUP" to enter the repeater group selection mode.
- ⑧ Touch [▲] or [▼](D) to select the desired repeater group (01 to 25).
  - The selected repeater group is displayed on the REPEATER LIST EDIT screen.



Touch "GROUP"



Example: "Japan"

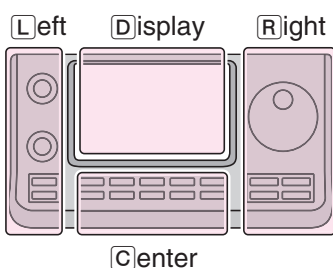

The L, R, C or D in the instructions indicate the part of the controller.

- L: Left side
- R: Right side
- C: Center bottom
- D: Display (Touch screen)

Continued on the next page.



Repeater list programming (Continued)

7. Access repeater setting

The programmed repeaters can be used as an access repeaters in the DR mode.  
 For simplex operation, or when the programmed repeater is not used as an access repeater, select "NO." In this case, the programmed repeater does not appear in the "FROM" selection.

- 29 Touch "USE(FROM)."
- The "USE(FROM)" screen appears.
- 30 Touch "YES."
- You can select the programmed repeater as an access repeater (FROM).



Touch "USE(FROM)"

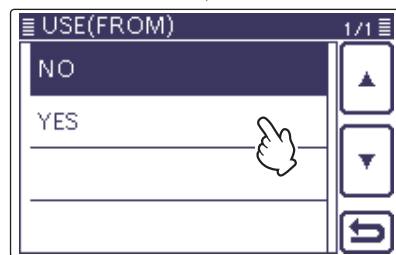

Touch "YES"

8. Access repeater frequency programming

This item appears only when "YES" is selected in '7. Access repeater setting.'

- 31 Touch "FREQUENCY" to enter the frequency edit mode.
- A cursor appears and blinks.
- 32 Touch the desired number to enter the desired frequency shift.
- Touch [CE](D) to delete the selected number.
- Touch [←](D) to move the cursor backwards, or touch [→](D) to move the cursor forwards.
- \*If desired, touch the frequency for 1 second to open the Function set window, and then touch the "Frequency Clear" to delete the frequency.
- 33 After entering, touch [ENT](D).

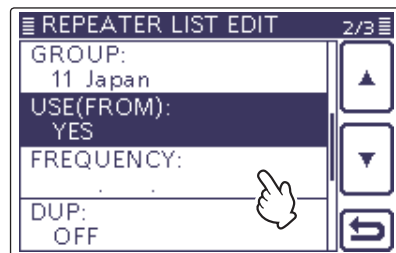

Touch "FREQUENCY"

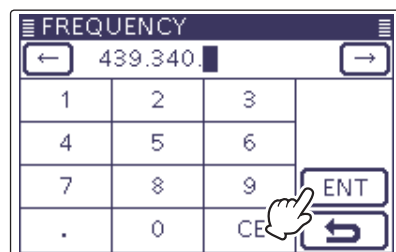
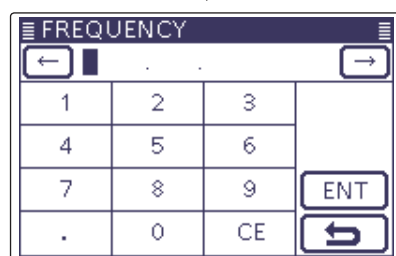

Example: "439.340"

Touch [ENT]

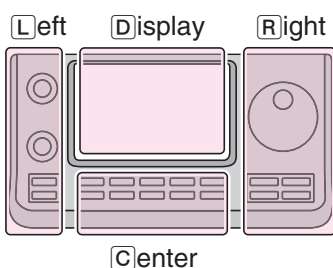

The L, R, C or D in the instructions indicate the part of the controller.

- L: Left side
- R: Right side
- C: Center bottom
- D: Display (Touch screen)

Continued on the next page.

Repeater list programming (Continued)

9. Duplex direction setting

- This item appears only when “YES” is selected in ‘7. Access repeater setting.’
- “DUP-” is automatically set when the access repeater frequency is programmed in ‘8. Access repeater frequency programming.’
- If necessary, you can change the **duplex** direction.

- Touch “DUP:.”
- Touch a desired duplex direction item.
  - OFF: Turn the duplex function OFF. For a simplex operation, this item MUST be set to “OFF.”
  - DUP-: The transmit frequency shifts down from the receive frequency by the offset amount.
  - DUP+: The transmit frequency shifts up from the receive frequency by the offset amount.

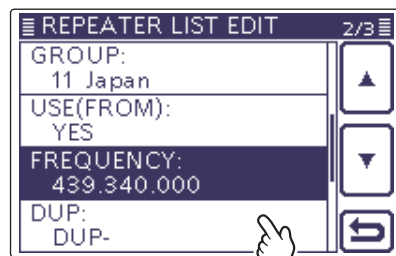

Touch “DUP”

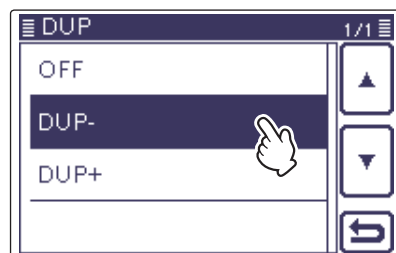

Touch “DUP-”

10. Frequency offset programming

- This item appears only when “YES” is selected in ‘7. Access repeater setting.’
- The offset value\* is automatically set when the access repeater frequency is programmed in ‘8. Access repeater frequency programming.’
- \*The default value differs, depending on the version.
- If necessary, you can change the frequency offset.

- Touch [▼](D).
- Touch “OFFSET FREQ” to enter the frequency offset edit mode.
  - A cursor appears and blinks.
- Touch the desired number to input the frequency offset.
  - Touch [CE](D) to delete the selected number.
  - Touch [←](D) to move the cursor backwards, or touch [→](D) to move the cursor forwards.
  - \*If desired, touch the frequency offset for 1 second to open the Function set window, and then touch the “Frequency Clear” to delete the frequency.
- After entering, touch [ENT](D).



Touch “OFFSET FREQ”

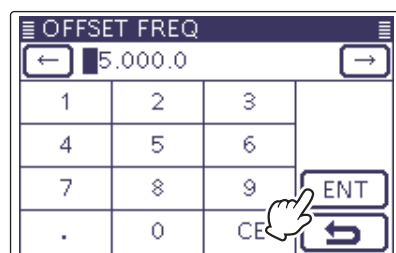

Example: “5.000.0”

Touch [ENT]

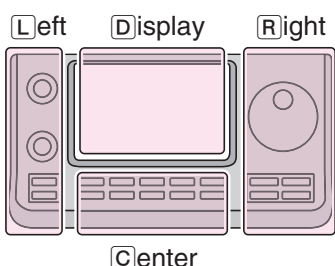

The L, R, C or D in the instructions indicate the part of the controller.

- L: Left side
- R: Right side
- C: Center bottom
- D: Display (Touch screen)

Continued on the next page.

**Repeater list programming (Continued)**

**11. Position data accuracy level setting**

When the Repeater Search function is not used, or the distance between your position and a repeater is not displayed, select "OFF."

- ④① Touch "POSITION".
- ④① Touch the position data accuracy level.
  - None: Select when the repeater has no position data.
  - Approximate: Select when the programmed position data is approximate.
  - Exact: Select when the programmed position data is exactly correct.



Touch "POSITION"

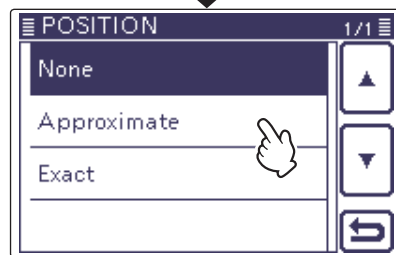

Example: "Approximate"

**12. Latitude programming**

This item appears only when "Approximate" or "Exact" is selected in '11. Position data accuracy level setting'.

- ④② Touch "LATITUDE," to enter the latitude data edit mode.
  - A cursor appears and blinks.
- ④③ Touch the desired number to input the latitude.
  - Touch [CE](D) to delete the selected number.
  - Touch [←](D) to move the cursor backwards, or touch [→](D) to move the cursor forwards.
  - Touch [N/S](D) to toggle between N and S modes.
- ④④ After entering, touch [ENT](D).

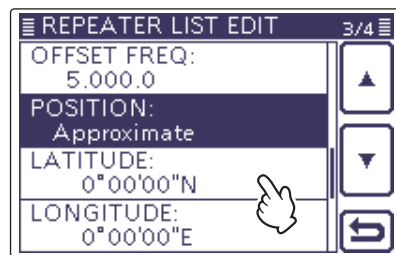

Touch "LATITUDE"

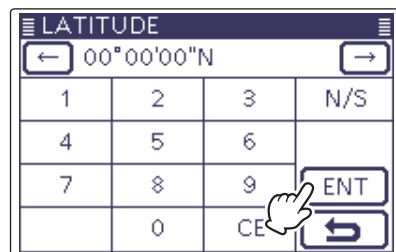

Touch [ENT]

**13. Longitude programming**

This item appears only when "Approximate" or "Exact" is selected in '11. Position data accuracy level setting'.

- ④⑤ Touch "LONGITUDE," to enter the longitude data edit mode.
  - A cursor appears and blinks.
- ④⑥ Touch the desired number to input the longitude.
  - Touch [CE](D) to delete the selected number.
  - Touch [←](D) to move the cursor backwards, or touch [→](D) to move the cursor forwards.
  - Touch [E/W](D) to toggle between E and W modes.
- ④⑦ After entering, touch [ENT](D).

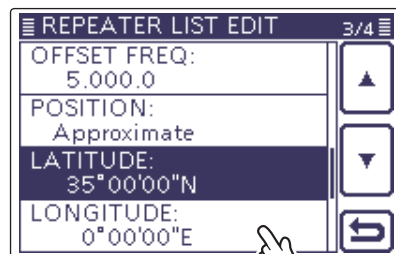

Touch "LONGITUDE"

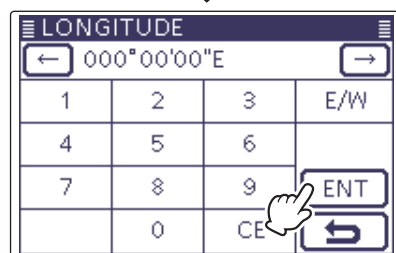

Touch [ENT]

Continued on the next page.

Repeater list programming (Continued)

14. UTC Offset programming

**UTC** (Universal Time Coordinated) offset is the time difference between UTC and repeater local time. This item enables you to check the destination repeater's time when you make a gateway call. (p. 9-44)

- 48 Touch [▼](D).
- 49 Touch "UTC OFFSET" to enter the UTC offset edit mode.
- 50 Touch [+] or [-](D) one or more times to input the time difference between UTC and the local time.
  - If desired, touch the UTC offset for 1 second to open the Function set window, and then touch the "Clear" to delete the UTC offset.
- 51 After entering, touch [↵](D).

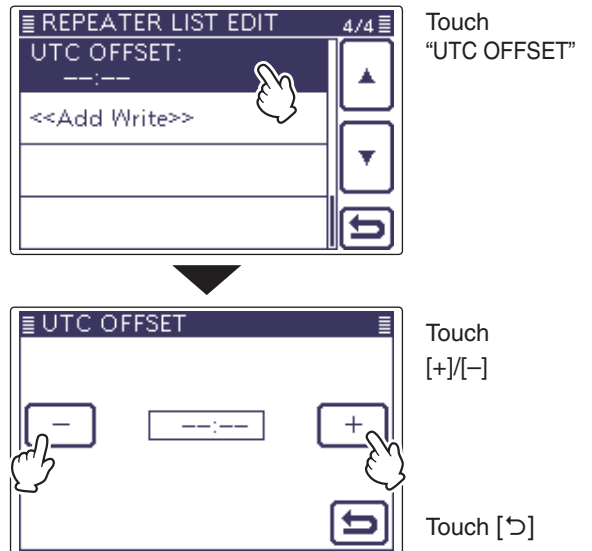

15. Storing the repeater list

- 52 Touch "<<Add Write>>".
- 53 Touch [YES](D).
  - The programmed contents are stored to the repeater list, and the display returns to the RPT LIST screen.

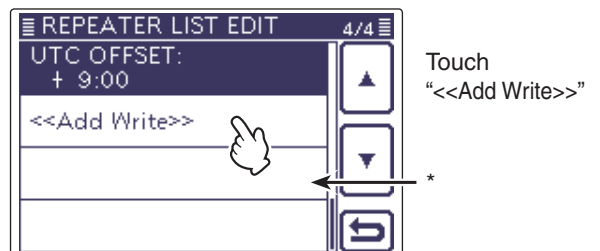

To cancel the programmed data:

To cancel the programmed data, push MENU(C) to display "Cancel edit?." Touch [YES](D) to cancel programming and the display returns the RPT LIST screen.

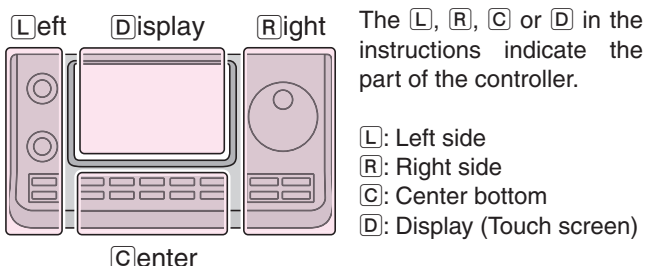
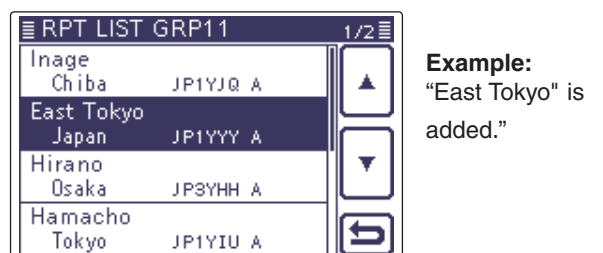
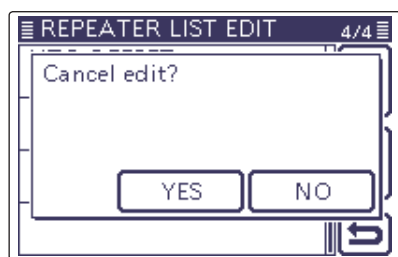

\* "<<Overwrite>>" appears when "Edit" is selected in [1. Repeater group selection].

## Editing a repeater list

This function reprograms a repeater's data. This is useful when already-programmed data is incorrect, has changed or some data should be added to the list.

- ① Push **SET**(C) to enter the Set mode.
- ② Touch the "Repeater List" item of the "DV Memory" Set mode.
  - DV Memory > **Repeater List**
  - If the specified item is not displayed, touch **[▲]** or **[▼]**(D) one or more times to select the page.
  - The repeater groups are displayed.
- ③ Touch **[▲]** or **[▼]**(D) to select the desired repeater group to be programmed.
  - The repeater list of the selected repeater group is displayed.
- ④ Push **QUICK**(C).
- ⑤ Touch **[Edit]**(D).
  - The "REPEATER LIST EDIT" screen is displayed.
  - See pages 9-30 to 9-37 for programming details.
- ⑥ Touch "<<Overwrite>>."
- ⑦ Touch **[YES]**(D).
  - The programmed contents are stored to the repeater list, and the display returns to the RPT LIST screen.



Touch "<<Over Write>>"

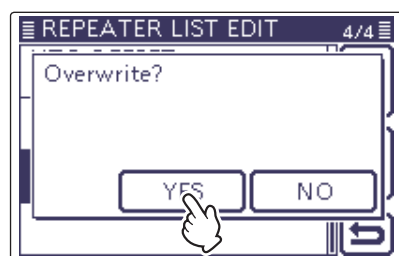

Touch [YES]



**Example:** "East Tokyo" is edited.

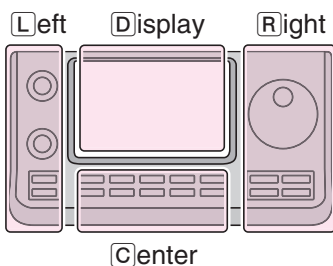

The L, R, C or D in the instructions indicate the part of the controller.

- L: Left side
- R: Right side
- C: Center bottom
- D: Display (Touch screen)

## Deleting a repeater list

The programmed repeater contents can be deleted from the repeater list.

- ① Push **SET**(C) to enter the Set mode.
- ② Touch the "Repeater List" item of the "DV Memory" Set mode.  
 DV Memory > **Repeater List**
  - If the specified item is not displayed, touch [▲] or [▼](D) one or more times to select the page.
  - The repeater groups are displayed.
- ③ Touch the repeater group that includes the repeater you want to delete.
  - If the specified repeater group is not displayed, touch [▲] or [▼](D) one or more times to select the page.
  - The repeater list of the selected repeater group is displayed.
- ④ Touch the repeater to be deleted for 1 second.
- ⑤ Touch [▼](D).
- ⑥ Touch "Delete."
- ⑦ Touch [YES](D).
  - The programmed repeater contents are deleted from the repeater list, and the display returns to the RPT LIST screen.

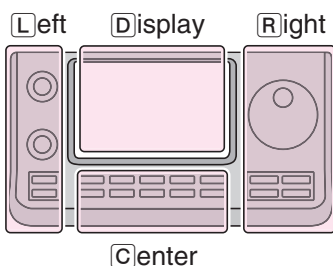
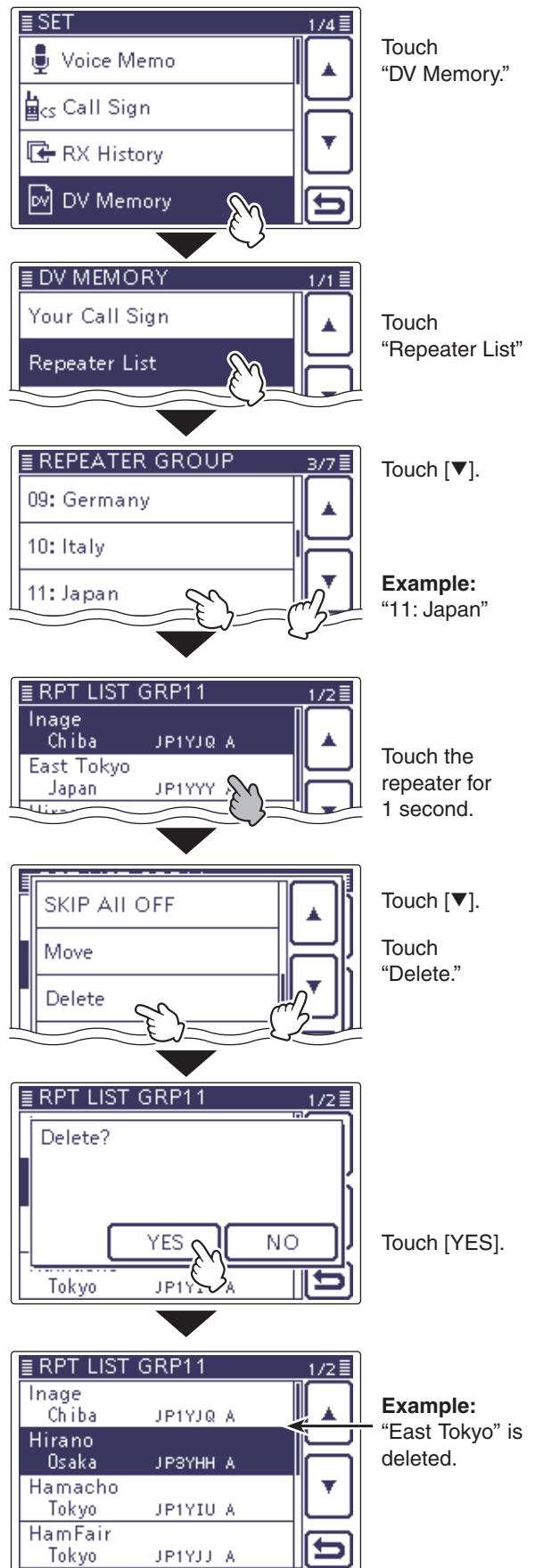

The L, R, C or D in the instructions indicate the part of the controller.

- L: Left side
- R: Right side
- C: Center bottom
- D: Display (Touch screen)

## Rearrange the display order of the repeater

You can move the programmed repeaters to rearrange their display order in the selected repeater group. The programmed repeater cannot be moved out of their assigned repeater group.

- ① Push **SET**(**C**) to enter the Set mode.
- ② Touch the "Repeater List" item of the "DV Memory" Set mode.
  - DV Memory > **Repeater List**
  - If the specified item is not displayed, touch [**▲**] or [**▼**](**D**) one or more times to select the page.
  - The repeater groups are displayed.
- ③ Touch the repeater group that includes the repeater you want to move.
  - If the specified repeater group is not displayed, touch [**▲**] or [**▼**](**D**) one or more times to select the page.
  - The repeater list of the selected repeater group is displayed.
- ④ Touch the repeater to be moved for 1 second.
- ⑤ Touch [**▼**](**D**).
- ⑥ Touch "Move."
  - "DESTINATION" blinks on the upper left of the LCD.
- ⑦ Touch the location to insert the repeater you want to move, which will be above the memory name selected in this screen.
  - The selected repeater is inserted to above the destination repeater name.
  - When "<<Move End>>" is selected, the selected repeater is moved to the bottom of the repeater group.

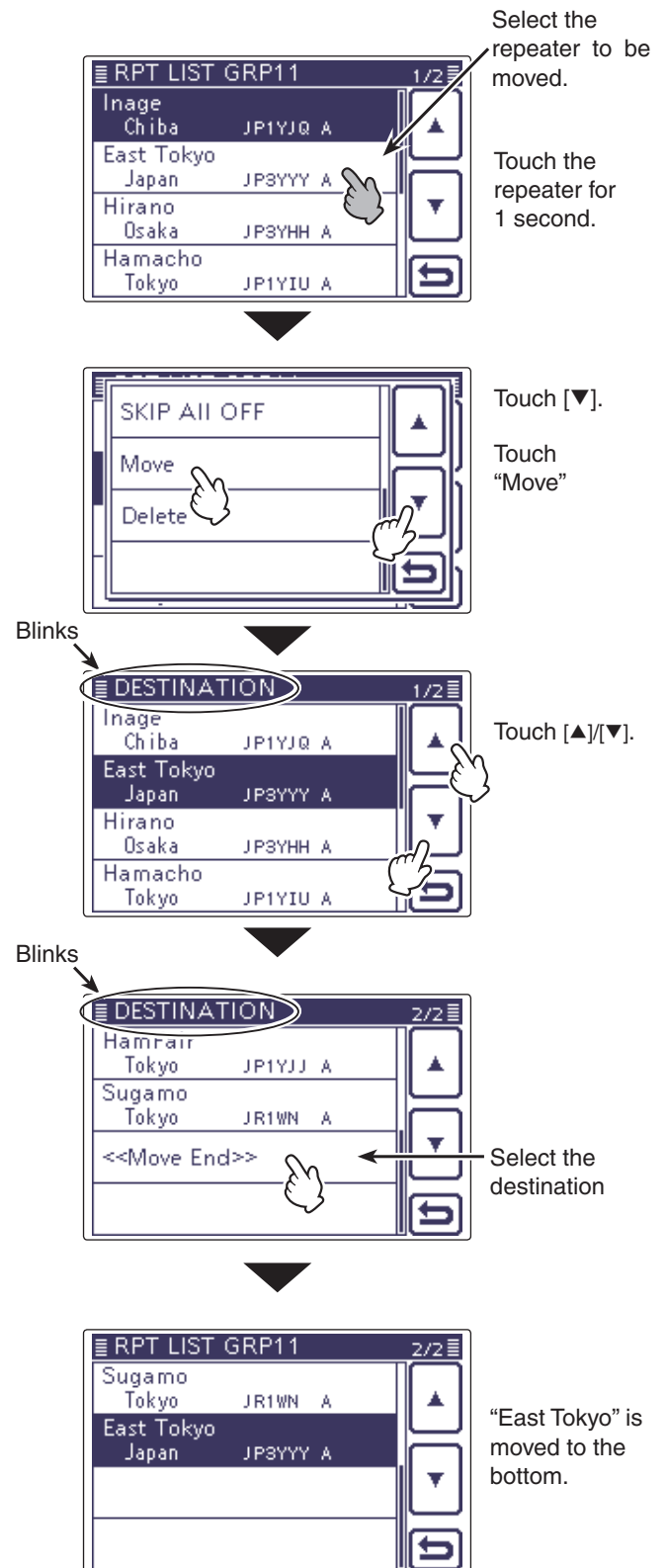



## Adding the Repeater information using the RX History

This section describes how to add a new repeater information to the repeater list using the RX history.

- ① Push **[DR]**(**[C]**) to enter the DR mode.
- ② Touch **[CD]**(**[D]**).
  - The “RX HISTORY” screen are displayed.
- ③ Touch **[▲]** or **[▼]**(**[D]**) to select the root item (“RX HISTORY”).
- ④ Touch the desired repeater you want to add to the repeater list.
  - The RX history detail screen is displayed.
- ⑤ Touch **[▲]** or **[▼]**(**[D]**) to display “RXRPT1” and “RXRPT2.”
- ⑥ Push **[QUICK]**(**[C]**).
- ⑦ Touch “Add To RPT List”.
- ⑧ Touch the repeater **call sign** that you want to add to the repeater list.
  - The “REPEATER LIST EDIT” screen is displayed. The selected repeater call sign is automatically programmed.
  - If necessary, edit the contents. (pp. 9-30 to 9-37)
- ⑨ Touch “<<Add Write>>.”
- ⑩ Touch “YES.”
  - The programmed contents are added to the repeater list, and the display returns to the RX HISTORY screen.

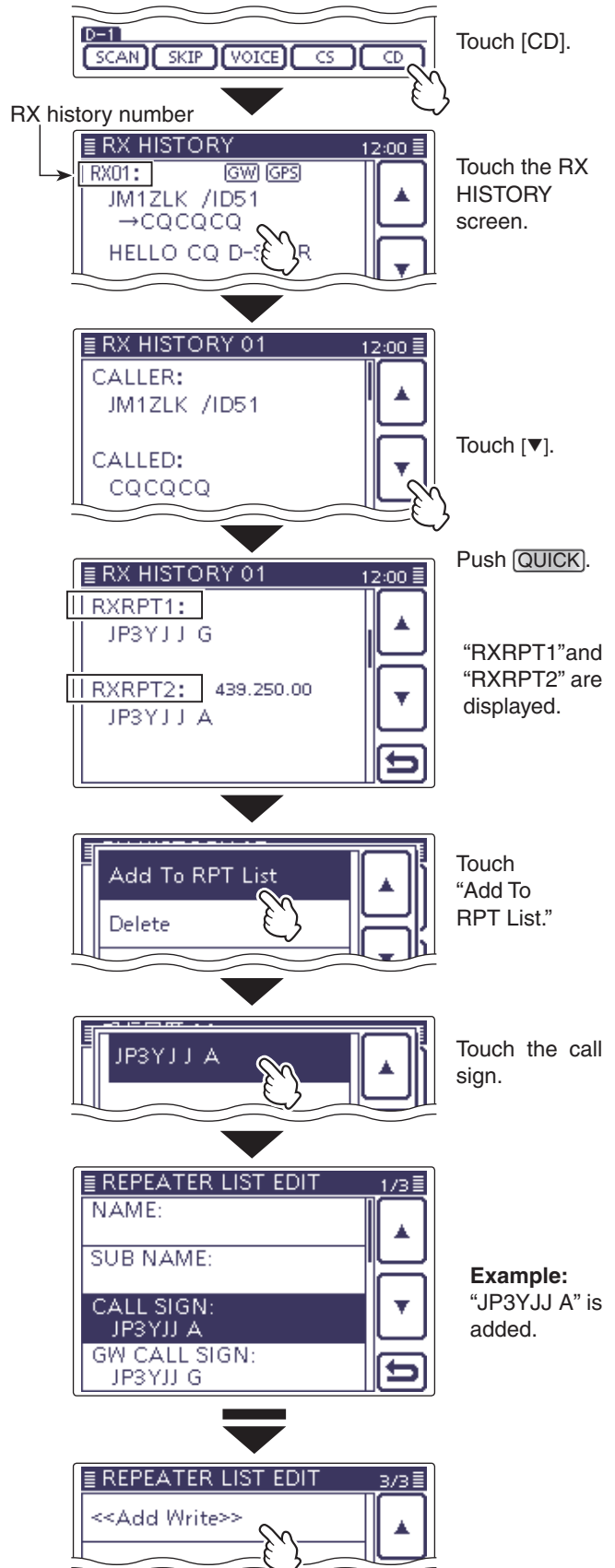

**How to switch the name display:**  
 When the call sign is displayed on the RX HISTORY screen, you can switch the display type to “Name Display.”  
 When the repeater name is not programmed in the repeater list, the display does not switch to the name display. It is convenient that you find a repeater that is not included in the repeater list.

➔ When the RX HISTORY screen is displayed, push **[QUICK]**(**[C]**) to display the Quick menu. Then touch “Name Display.”

## Skip setting for the DR mode scan

You can set unnecessary repeaters as scan skip targets. The selected repeaters are skipped during scanning for faster selection and scanning.  
 You can set the skip setting to all repeaters in the selected repeater group, or the individual repeater.

When a repeater is specified as a skip target, its "USE (FROM)" setting is automatically set to "NO." In this case, the repeater cannot be selected in "FROM" (Access repeater).

### ◆ Individual skip setting

- ① Push **SET**(C) to enter the Set mode.
- ② Touch the "Repeater List" item of the "DV Memory" Set mode.  
 DV Memory > **Repeater List**
  - If the specified item is not displayed, touch [▲] or [▼](D) one or more times to select the page.
  - The repeater groups are displayed.
- ③ Touch the repeater group that includes the repeater you want to set the skip setting on.  
  - If the specified item is not displayed, touch [▲] or [▼](D) one or more times to select the page.
- ④ Touch the repeater to be skipped during the DR mode scan.  
  - If the specified item is not displayed, touch [▲] or [▼](D) one or more times to select the page.
- ⑤ Touch the repeater to be skipped for 1 second.
- ⑥ Touch "SKIP".  
  - "SKIP" appears on the selected repeater.
  - Push **QUICK**(C) and select "SKIP" again to cancel the skip setting.
  - When "SKIP All ON" is selected, touch to set all repeaters in the group as skip targets.

### ◆ Group skip setting

- ① Push **SET**(C) to enter the Set mode.
- ② Touch the "Repeater List" item of the "DV Memory" Set mode.  
 DV Memory > **Repeater List**
  - If the specified item is not displayed, touch [▲] or [▼](D) one or more times to select the page.
  - The repeater groups are displayed.
- ③ Touch the repeater group to be skipped during the DR mode scan for 1 second.
- ④ Touch "SKIP All ON".  
  - "SKIP" appears on the selected repeater group.
  - Push **QUICK**(C) again and select "SKIP All OFF," then touch to cancel the skip setting.

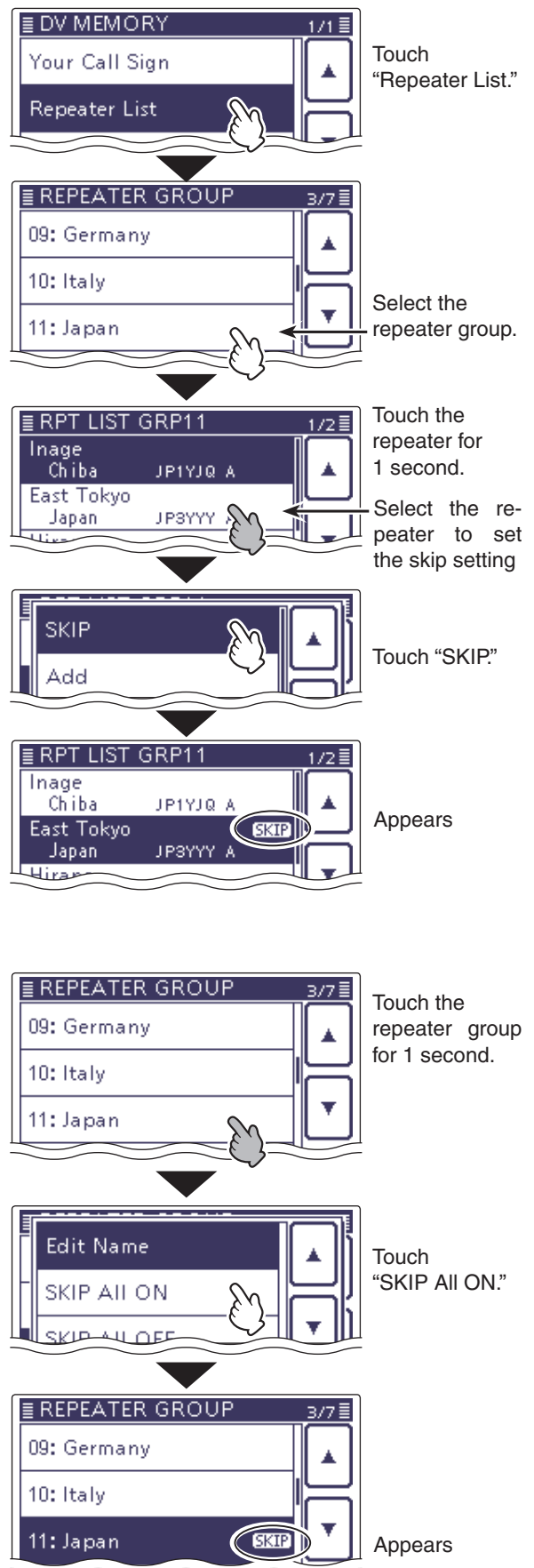

## Repeater group name programming

- ① Push **SET**(**C**) to enter the Set mode.
- ② Touch the "Repeater List" item of the "DV Memory" Set mode.
  - DV Memory > **Repeater List**
  - If the specified item is not displayed, touch **[▲]** or **[▼]**(**D**) one or more times to select the page.
  - The repeater groups are displayed.
- ③ Touch the repeater group for 1 second, you want to program the name.
- ④ Touch "Edit Name" to enter the group name edit mode.
- ⑤ Touch the desired block one or more times to select the desired character or symbol.

Selectable characters and symbols
A to Z, a to z, 0 to 9, ! # \$ % & \ ? " ' ` ^ + - * / . , : ; = < > ( ) [ ] { } ! _ ' @ (space)

- Touch "AB↔12" to toggle between the Alphabet input and Number input mode.
  - Touch **[CLR]**(**D**) to delete the selected character, symbol or number.
  - Touch **[ [AB] ]**(**D**) to open the input mode selection window.
  - Touch " \_ " to input a space.
- ⑥ Touch **[←]**(**D**) to move the cursor backwards, or touch **[→]**(**D**) to move the cursor forwards.
  - ⑦ Repeat steps ⑤ and ⑥ to enter a name of up to 16 characters, including spaces.
  - ⑧ After entering the name, touch **[ENT]**(**D**).



Touch "Repeater List."



Touch the repeater group for 1 second.  
**Example:** "21."



Touch "Edit Name."

### Name edit screen

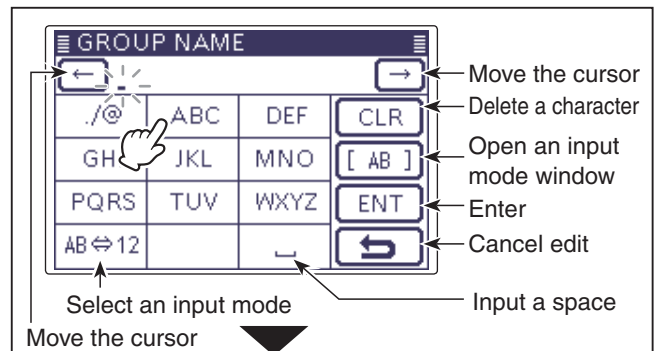

### Input mode selection screen

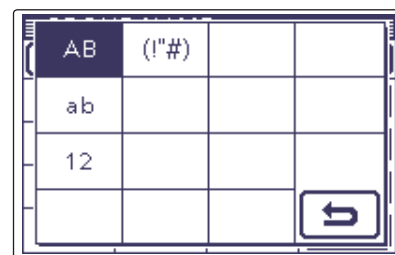

**Example:** "China" is programmed.

Touch **[ENT]**.

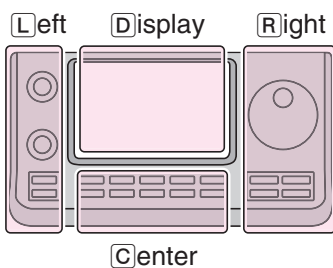

The **L**, **R**, **C** or **D** in the instructions indicate the part of the controller.

- L**: Left side
- R**: Right side
- C**: Center bottom
- D**: Display (Touch screen)

## Repeater detail screen

According to the programmed contents, such as position data, UTC offset, and so on, the distance between your position and the repeater or repeater time can be displayed on the REPEATER DETAIL screen. The Detail screen can also be entered in the “FROM SELECT” screen.

- ① Push **DR**(**C**) to enter the DR mode.
  - The DR mode is selected.
- ② Touch the “TO” field.
- ③ Touch “Gateway CQ.”
- ④ Touch the repeater group.
  - Example: “11: Japan”
- ⑤ Touch the repeater for 1 second.
  - Example: “Hirano”
- ⑥ Touch “Detail.”
- The REPEATER DETAIL screen is displayed.
- ⑦ Touch **[↶]**(**D**) to return to the RPT LIST screen.

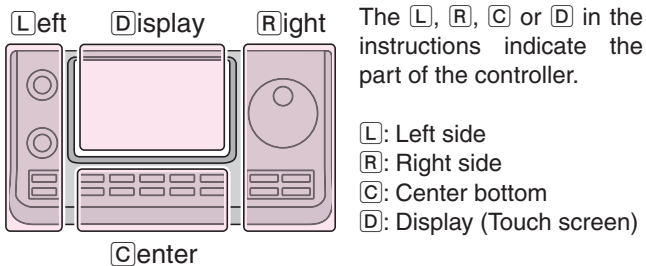

While in the DR mode, and if you set the repeater as shown to the right, the repeater details screen can be displayed.

- ① Touch **QUICK**(**C**) or touch the repeater for 1 second to open the quick menu screen.
- ② Touch “Repeater Detail.”
  - The REPEATER DETAIL screen is displayed.



**Example:** Shows the “Hirano” repeater detail screen

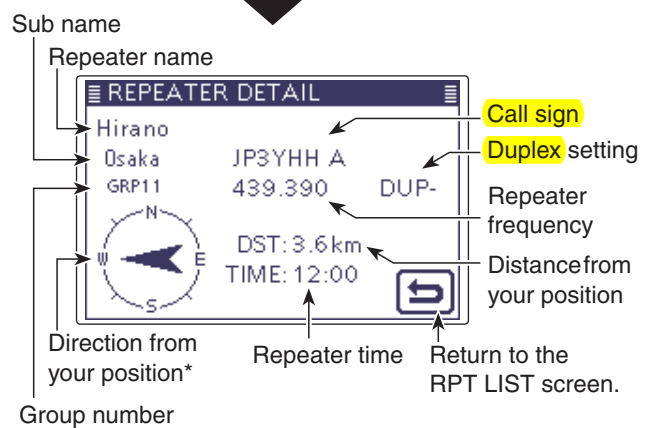
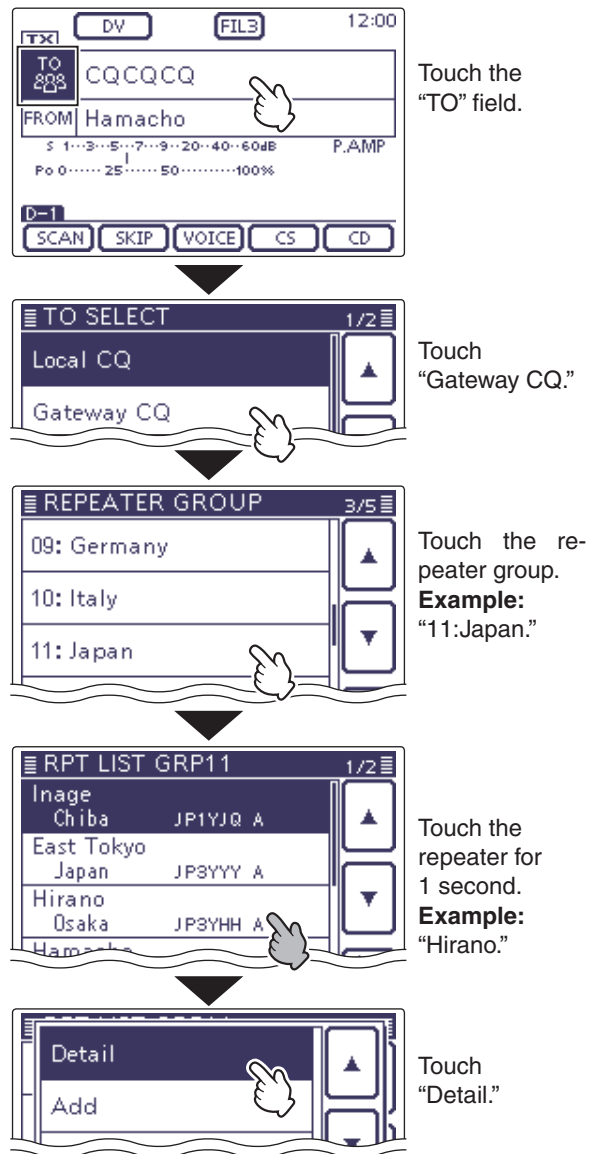

\* When the position data accuracy level is set to “Approximate,” direction data is not displayed if the distance to the repeater is under 5 kilometers.

## Your (destination) call sign programming

A Your (destination) **call sign** can be manually programmed.

The Your (destination) call sign is set to "TO," you can make a call to a station, even if you don't know where the station is currently located.

Up to 200 Your call signs can be programmed.

- ① Push **SET**(**C**) to enter the Set mode.
- ② Touch the "Your Call Sign" item of the "DV Memory" Set mode.
  - DV Memory > **Your Call Sign**
    - If the specified item is not displayed, touch **[▲]** or **[▼]**(**D**) one or more times to select the page.
    - The your call sign list are displayed.
- ③ Touch the list for 1 second.
- ④ Touch "Add" to enter the edit mode.
- ⑤ Touch "NAME" to enter the name edit mode.
  - A cursor appears and blinks.
- ⑥ Touch the desired block one or more times to select the desired character or symbol.
  - (Example: T)

Selectable characters and symbols
A to Z, a to z, 0 to 9, ! # \$ % & \ ? " ' ` ^
+ - * / . , : ; = < > ( ) [ ] { }   _ ` @ (space)

- Touch "AB↔12" to toggle between the Alphabet input and Number input mode.
  - Touch **[CLR]**(**D**) to delete the selected character, symbol or number.
  - Touch **[ [AB] ]**(**D**) to open the Input mode selection window.
  - Touch "\_" to input a space.
- ⑦ Touch **[←]**(**D**) to move the cursor backwards, or touch **[→]**(**D**) to move the cursor forwards.
  - ⑧ Repeat steps ⑥ and ⑦ to enter a name of up to 16 characters, including spaces.
    - (Example: First, T, then O, then M.)
  - ⑨ After entering the name, touch **[ENT]**(**D**).
    - The programmed name are stored to the your call sign list, and the display returns to the YOUR CALL SIGN EDIT screen.

**Example:** Program "TOM/JM1ZLK" to the Your Call Sign memory.

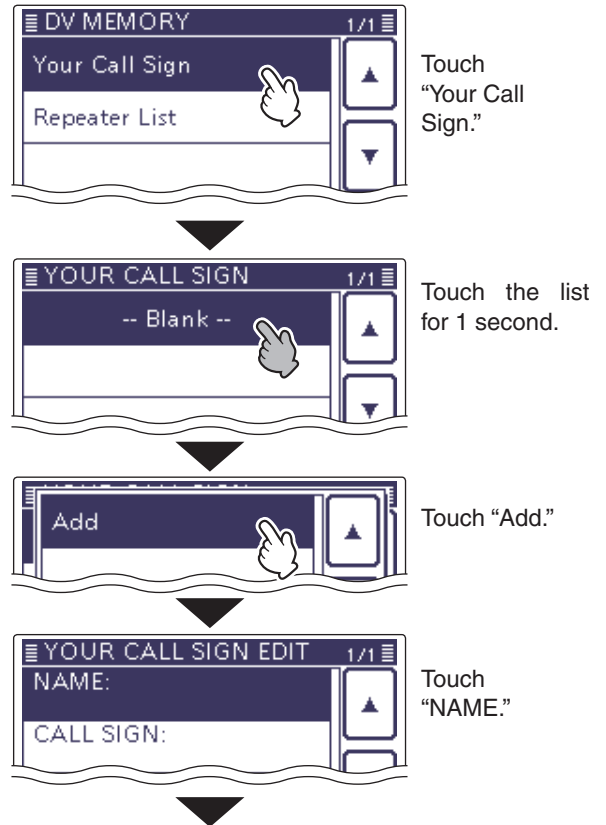

### Name edit screen

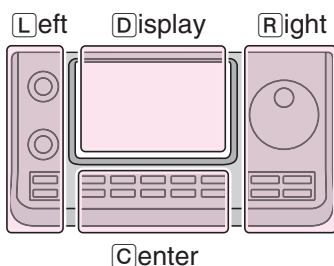
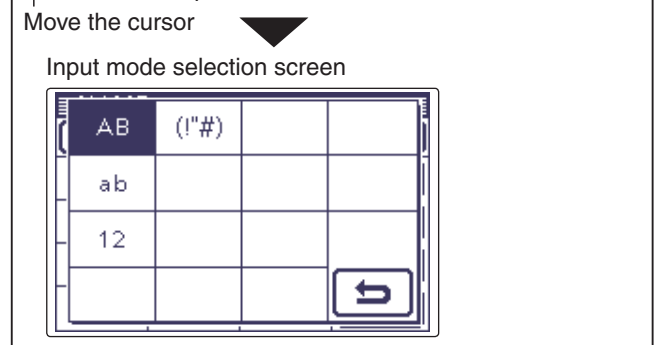
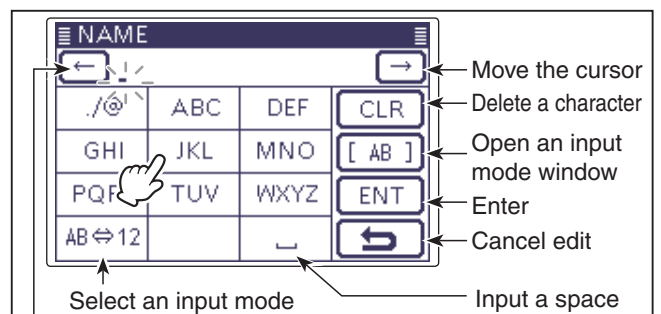

The **L**, **R**, **C** or **D** in the instructions indicate the part of the controller.

- L**: Left side
- R**: Right side
- C**: Center bottom
- D**: Display (Touch screen)

Continued on the next page

**Your (destination) call sign programming (Continued)**

- ⑩ Touch "CALL SIGN" to enter the your call sign edit mode.
  - A cursor appears and blinks.
- ⑪ Touch the desired block one or more times to select the desired character or symbol.
  - (For example: J)
  - A to Z, 0 to 9, / and a space can be selected.
  - Touch "AB↔12" to toggle between the Alphabet input and Number input mode.
  - Touch [CLR](D) to delete the selected character, symbol or number.
  - Touch " " to input a space.
- ⑫ Touch [←](D) to move the cursor backwards, or touch [→](D) to move the cursor forwards.
- ⑬ Repeat steps ⑪ and ⑫ to enter a call sign of up to 8 characters, including spaces.
  - (For example: First, J, then M, then 1, then Z, then L, then K.)
- ⑭ After entering the your call sign, touch [ENT](D).
- ⑮ Touch "<<Add Write>>."
- ⑯ Touch [YES](D).
- ⑰ Push [SET](C) to exit the Set mode.

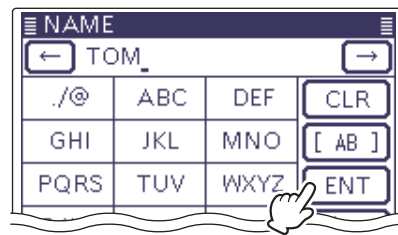

Example: "TOM"

Touch [ENT].



Touch "CALL SIGN."

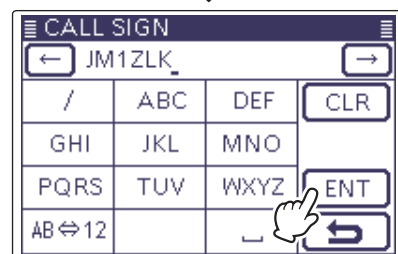

Example: "JM1ZLK"

Touch [ENT].

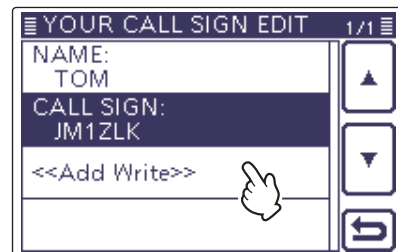

Touch "<<Add Write>>."

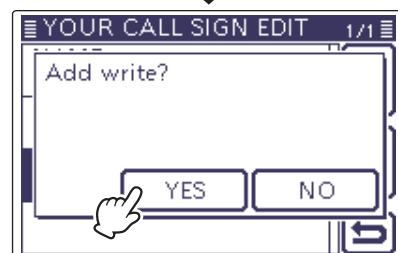

Touch [YES].

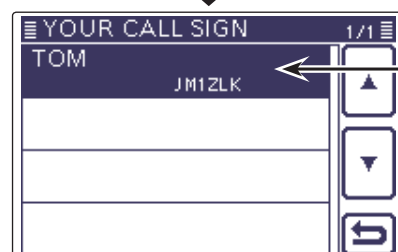

"TOM JM1ZLK" is programmed into the Your Call Sign memory.

**To cancel the programmed data:**  
 To cancel the programmed data, push [MENU](C) to display "Cancel edit?." Touch "YES" to cancel programming and the display returns the YOUR CALL SIGN screen.

## Editing a Your (destination) call sign

This function reprograms a Your (destination) **call sign's** data. This is useful when already-programmed data is incorrect, has changed or some data should be added to the list.

- ① Push **SET**(**C**) to enter the Set mode.
- ② Touch the "Your Call Sign" item of the "DV Memory" Set mode.
  - DV Memory > **Your Call Sign**
  - If the specified item is not displayed, touch [**▲**] or [**▼**](**D**) one or more times to select the page.
  - The your call sign list are displayed.
- ③ Touch the desired your call sign to be programmed for 1 second.
  - If the specified item is not displayed, touch [**▲**] or [**▼**](**D**) one or more times to select the page.
- ④ Touch [**Edit**](**D**).
  - The "YOUR CALL SIGN EDIT" screen is displayed.
  - See pages 9-45 to 9-46 for programming details.
- ⑤ Touch "<<Overwrite>>."
- ⑥ Touch "YES."
  - The programmed contents are stored to the your call sign list, and the display returns to the YOUR CALL SIGN screen.

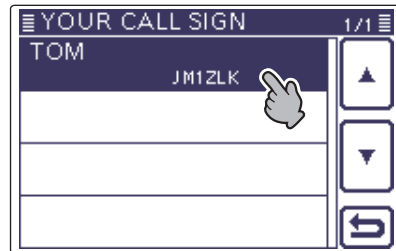

Touch the list for 1 second.



Touch "Edit."



Touch "<<Overwrite>>."

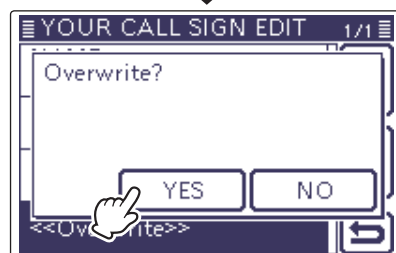

Touch "YES."



"TOM/7100 JM1ZLK" is programmed into the Your Call Sign memory.

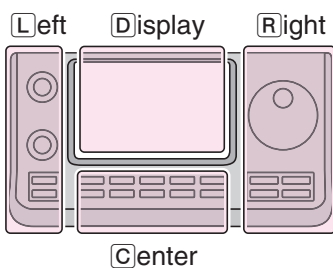

The **L**, **R**, **C** or **D** in the instructions indicate the part of the controller.

- L**: Left side
- R**: Right side
- C**: Center bottom
- D**: Display (Touch screen)



## Rearrange the display order of Your (destination) call sign

You can move Your **call signs** to rearrange their display order.

It is easy to find stations that you often communicate if the stations are moved to the top of the memory.

- ① Push **SET**(**C**) to enter the Set mode.
- ② Touch the "Your Call Sign" item of the "DV Memory" Set mode.
  - DV Memory > **Your Call Sign**
    - If the specified item is not displayed, touch [**▲**] or [**▼**](**D**) one or more times to select the page.
    - The your call sign list are displayed.
- ③ Touch the call sign you want to move for 1 second.
  - If the specified call sign is not displayed, touch [**▲**] or [**▼**](**D**) one or more times to select the page.
- ④ Touch "Move."
  - "DESTINATION" blinks on the upper left of the LCD.
- ⑤ Touch the location to insert the call sign you want to move, which will be above the memory name selected in this screen.
  - The selected call sign is inserted to above the destination.
  - When "<<Move End>>" is selected, the selected call sign is moved to the bottom of the YOUR CALL SIGN screen.

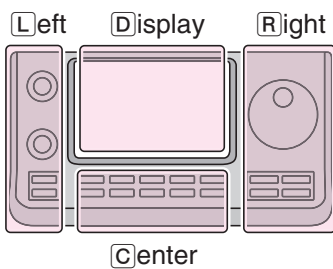

The **L**, **R**, **C** or **D** in the instructions indicate the part of the controller.

- L**: Left side
- R**: Right side
- C**: Center bottom
- D**: Display (Touch screen)

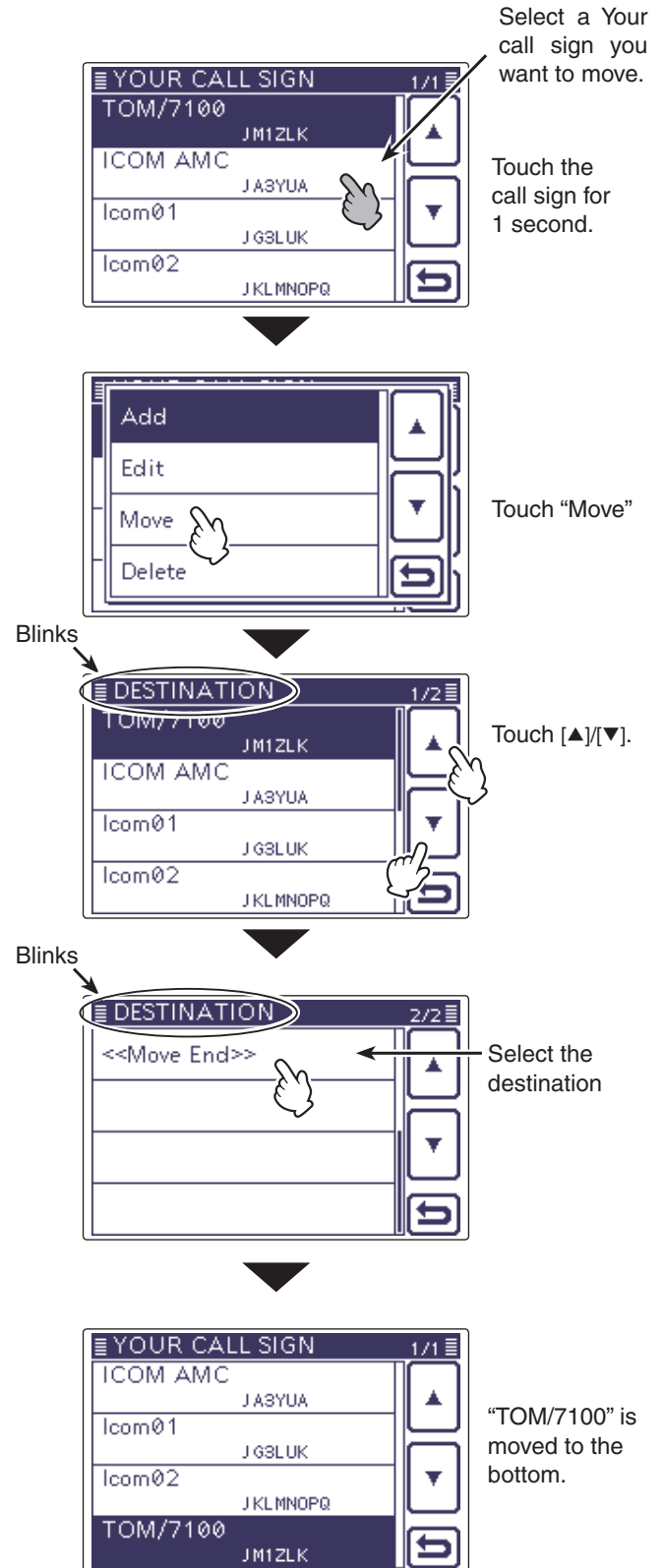

## Deleting Your (destination) call sign

The Your (destination) call signs can be deleted from the Your Call Sign memory.

- ① Push **SET**(**C**) to enter the Set mode.
- ② Touch the "Your Call Sign" item of the "DV Memory" Set mode.
  - DV Memory > **Your Call Sign**
  - If the specified item is not displayed, touch **[▲]** or **[▼]**(**D**) one or more times to select the page.
  - The your call sign list are displayed.
- ③ Touch the call sign you want to delete for 1 second .
  - If the specified call sign is not displayed, touch **[▲]** or **[▼]** (**D**) one or more times to select the page.
- ④ Touch "Delete."
- ⑤ Touch "YES."
  - The programmed call sign contents are deleted from the your call sign list, and the display returns to the YOUR CALL SIGN screen.

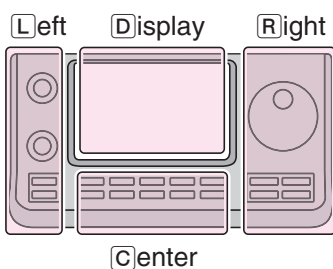
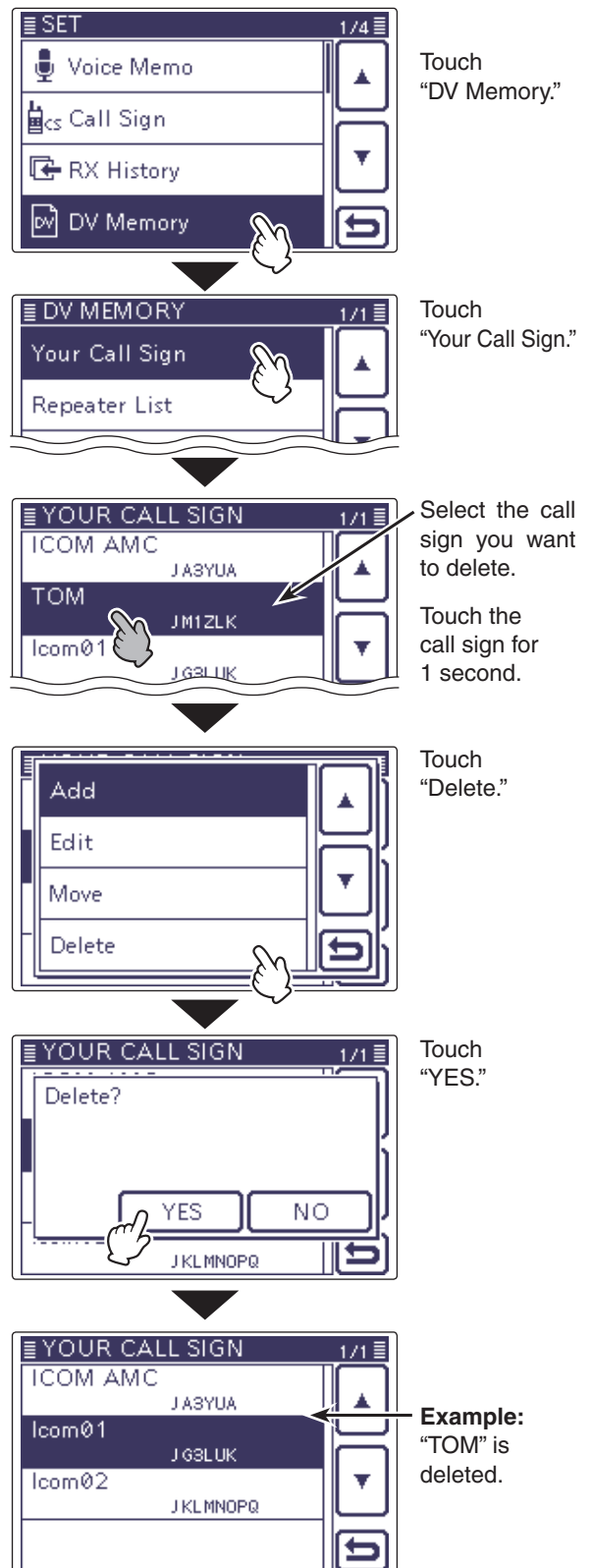

The **L**, **R**, **C** or **D** in the instructions indicate the part of the controller.

- L**: Left side
- R**: Right side
- C**: Center bottom
- D**: Display (Touch screen)

## Your setting is correct?

If you make a Local Area call with the Gateway call setting, the destination repeater, selected in "TO," will be busy while you transmit.

So the station that uses that repeater as their Access repeater cannot access it, as shown below.

**BE SURE** to set CQCQCQ in "TO" when you intend to make a local call, or after you finish a Gateway call.

Example: JM1ZLK wants to make a Local Area call.

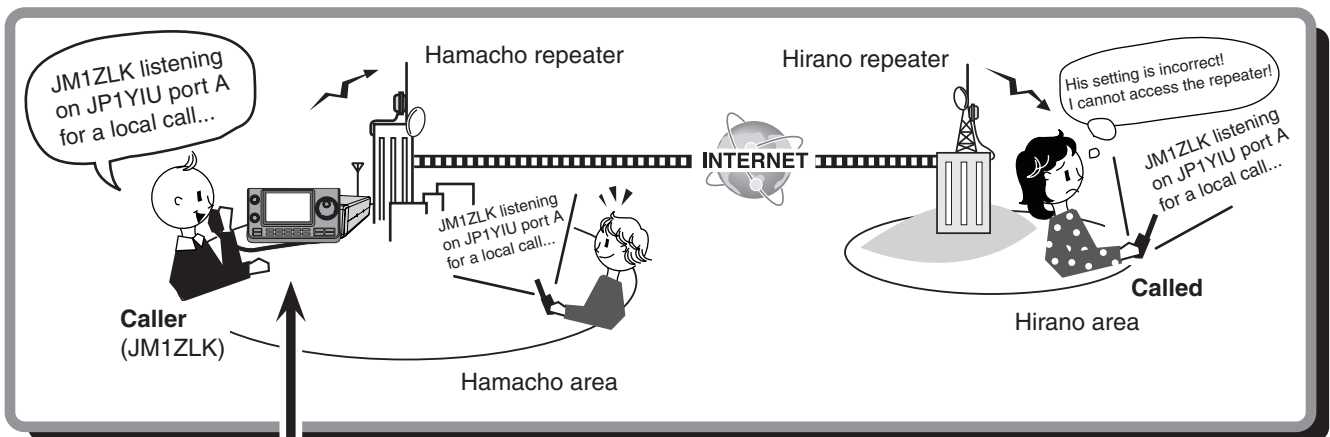

JM1ZLK's setting

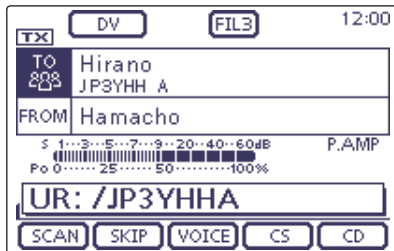

The destination ("TO") setting is incorrect.

**NOTE:** With this setting, the Local Area call can be made, but the destination repeater, selected in "TO," is also busy while you transmit. So the station that uses that repeater as their Access repeater cannot access it.

Correct setting

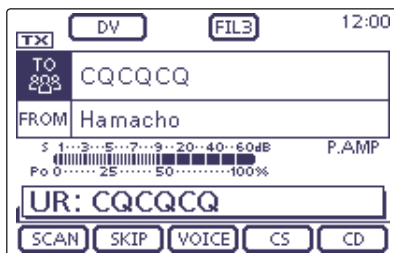

To make a Local Area call, set the destination ("TO") to "CQCQCQ." See page 8-15 for details.

# Section 10      GPS/GPS-A OPERATION

---

<b>GPS operation.....</b>	<b>10-2</b>
◇ GPS receive setting.....	10-2
<b>Checking GPS position.....</b>	<b>10-3</b>
◇ Displaying Position Data.....	10-3
◇ Changing the GPS memory and alarm .....	10-4
◇ About the Grid Locator .....	10-4
◇ Changing the Compass Direction.....	10-4
◇ Saving your own or received position data.....	10-5
<b>Checking GPS information (Sky view screen).....</b>	<b>10-6</b>
<b>Adding or editing GPS memory .....</b>	<b>10-7</b>
◇ GPS memory.....	10-7
◇ Add a GPS memory .....	10-7
◇ GPS group name programming .....	10-11
◇ Clearing a GPS data .....	10-12
◇ Moving a GPS data .....	10-13
◇ GPS alarm setting.....	10-14
<b>Transmitting GPS data.....</b>	<b>10-16</b>
◇ GPS data sentence setting.....	10-16
◇ GPS message programming.....	10-17
<b>Transmitting GPS-A data .....</b>	<b>10-18</b>
◇ D-PRS .....	10-18
◇ Operating GPS-A .....	10-18
◇ Setting GPS-A.....	10-19
◇ Displaying your position using a mapping software.....	10-21
<b>GPS Auto transmission for only Simplex.....</b>	<b>10-22</b>
◇ Setting the GPS automatic transmission.....	10-22

## GPS operation

You can display your own GPS data in all operating modes. You can also transmit GPS data when in the DV mode. To receive GPS data, connect a third-party GPS receiver that has an RS-232C output and NMEA data format.

### ◇ GPS receive setting

The **L**, **R**, **C** or **D** in the instructions indicate the part of the controller.

- L**: Left side, **R**: Right side, **C**: Center bottom
- D**: Display (Touch screen)

- ① Push **SET**(**C**) to enter the Set mode.
- ② Touch the "GPS Select" item of the "GPS Set" Set mode.  
GPS > GPS Set > **GPS Select**
  - If the specified item is not displayed, touch **▲** or **▼**(**D**) one or more times to select the page.

③ Touch "External GPS."

- ④ Push **SET**(**C**) to exit the set mode.
  - The GPS icon blinks when receiving data.
  - If "Manual" was selected, the icon does not appear.
  -  (Disappears)

• The GPS icon stops blinking when valid data is received.



• It may take only a few seconds to receive. But depending on the environment, it may take a few minutes. If you have difficulties receiving, we recommend that you try a different location.

▨ If the "DATA 1" item in the "Connectors" Set mode is set to other than "GPS" (default), set to "GPS." (p. 17-25)

▨ Connectors > USB2/DATA1 Function > **DATA1 Function**

▨ Set the "GPS Receiver Baud rate" item in the "GPS" Set mode, according to your GPS receiver. (Default: 4800)

▨ GPS > GPS Set > **GPS Receiver Baud rate**

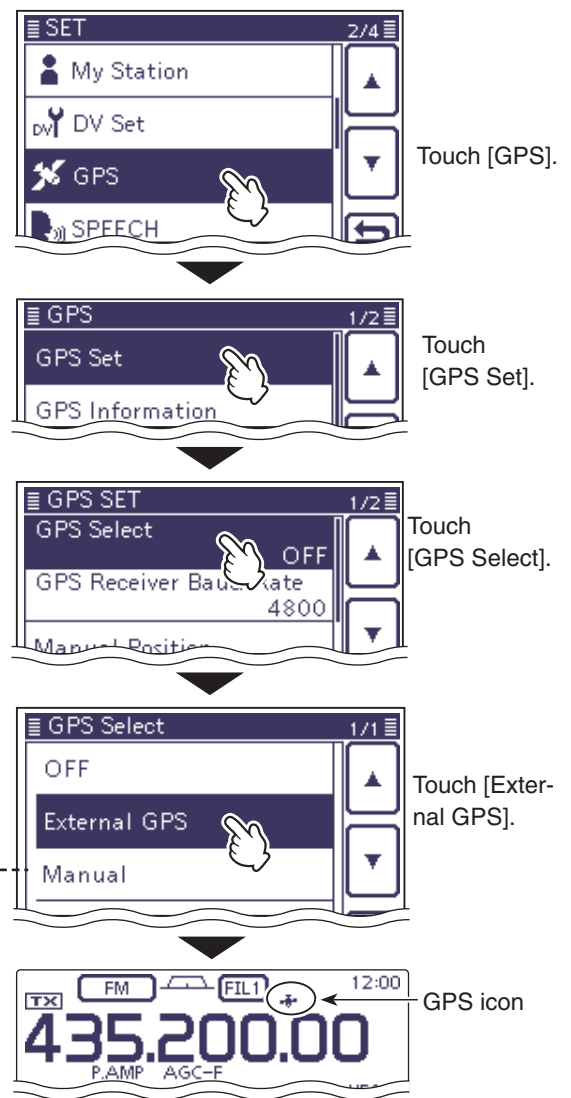
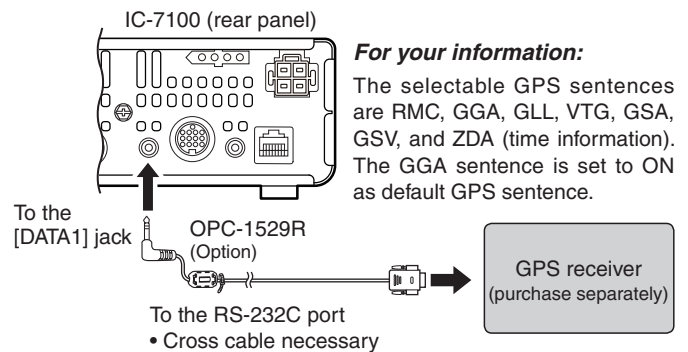

### Manually entering your position data

When operating on a fixed station, and know the longitude and latitude of the operating location, "Manual" can be selected and used.

After selecting [Manual], touch "Manual Position" in the "GPS SET" screen, push **QUICK**(**C**), and then touch "Edit" to enter your position data.

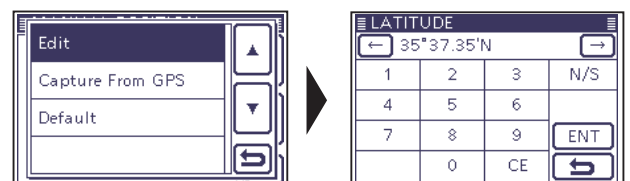

You can capture the data to the Manual Position which received from the external GPS by selecting "Capture From GPS."

## Checking GPS position

You can check your current position.

### ◇ Displaying Position Data

- ① Push **QUICK**(C).
- ② Touch **[▲]/[▼]**(D) one or more times and select "GPS Position."
- ③ Touching **[▲]/[▼]**(D) allows you change between my (MY) screen, the received (RX) screen, the GPS memory (MEM) channel screen, and the GPS alarm (ALM) channel screen.

- **MY:** Displays your latitude, longitude, grid locator, altitude, speed\*, time, compass heading\* and direction\*.
- **RX:** Displays the position of the station you are receiving from in latitude, longitude, grid locator, altitude, the distance from the station to you, SSID, course, speed, GPS symbol, and the direction.
  - Depending on the activity of the station you are receiving from, some data may not be displayed.
- **MEM:** Displays the position of the GPS memory channel in latitude, longitude, grid locator, the distance from the station to you, and the direction.
- **ALM:** Displays the position of the GPS memory channel with the alarm set in latitude, longitude, grid locator, the distance from the station to you, and the direction.

\* If "Manual" is selected, speed, compass heading and direction do not appear. (p. 10-2)

GPS > GPS Set > **GPS Select**

- ④ Push **SET**(C) to exit the "GPS POSITION" screen.

#### NOTE:

- Latitude, longitude, and altitude may differ, depending on your GPS.
- Also, the time may not be displayed, depending on the GPS.

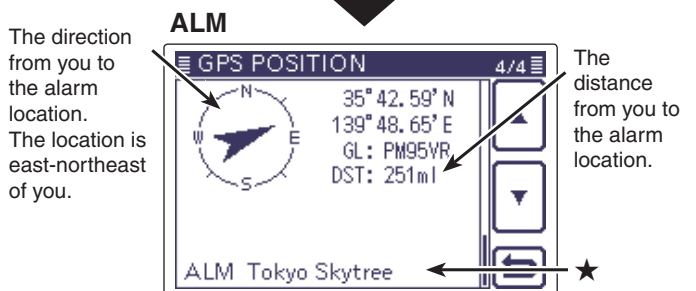
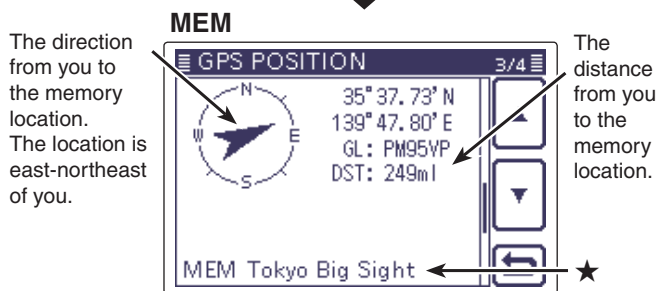
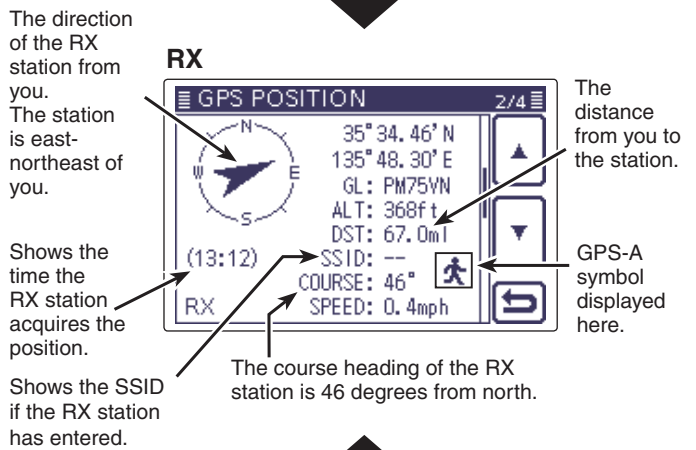
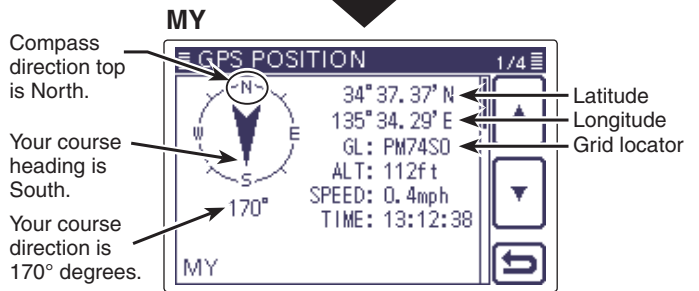
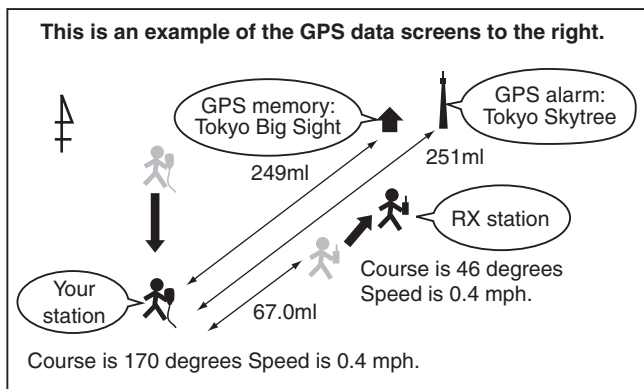

★ When a name is not assigned to the memory channel, Day and Time are displayed instead of the name.

Checking GPS position (Continued)

◇ Changing the GPS memory and alarm

GPS memory and GPS alarm contents can be changed in the “GPS Position” screen.

- ① While displaying the **MEM** or **ALM** screen, push **QUICK**(C).
- ② While displaying the **MEM** screen, touch [GPS Memory Select], and while displaying the **ALM** screen, touch [Alarm Select].
- ③ Touch [▲]/[▼](D) to change the GPS memory and alarm contents.

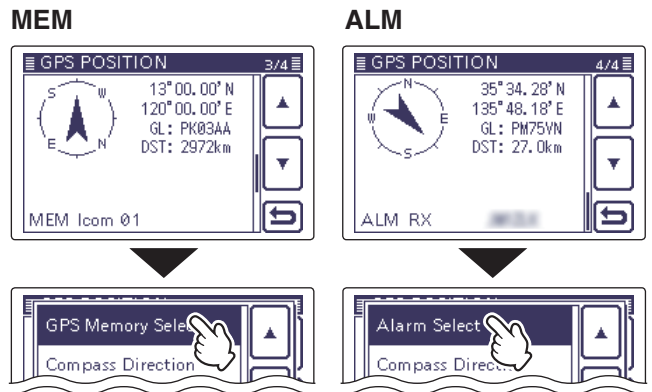

◇ About the Grid Locator

Grid Locator (GL) is a location compressed into a 6 character code, calculated by the longitude and the latitude.

The locator is simply calculated by dividing the earth surface into squares.

It is used to find the location of a radio station.

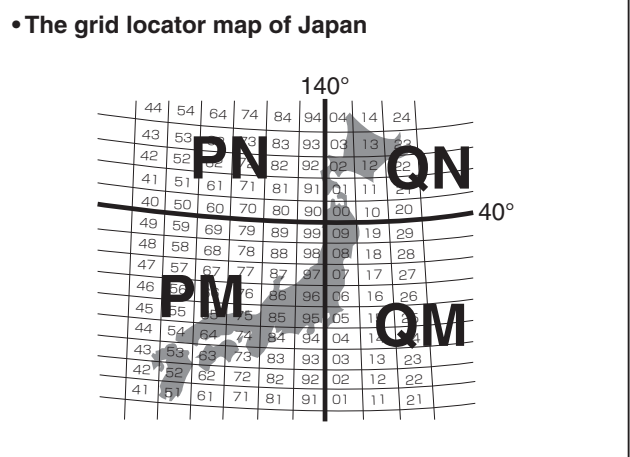
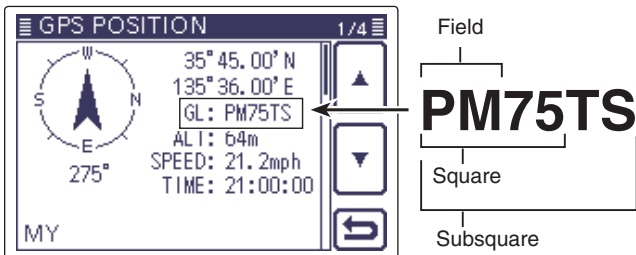

◇ Changing the Compass Direction

You can change the compass direction between Heading Up, North Up and South Up.

- ① While displaying the **MY**, **RX**, **MEM**, or **ALM** screen push **QUICK**(C).
- ② Touch “Compass Direction.”
- ③ Touch to select the compass direction.
  - Heading Up: The compass always pointed to your heading course direction.
  - North Up: The top is always north.
  - South Up: The top is always south.

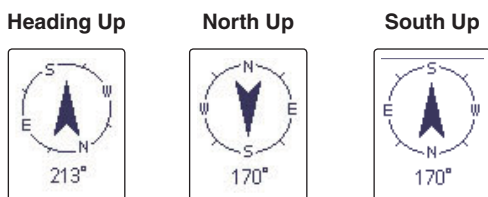

Example; Changing to North Up

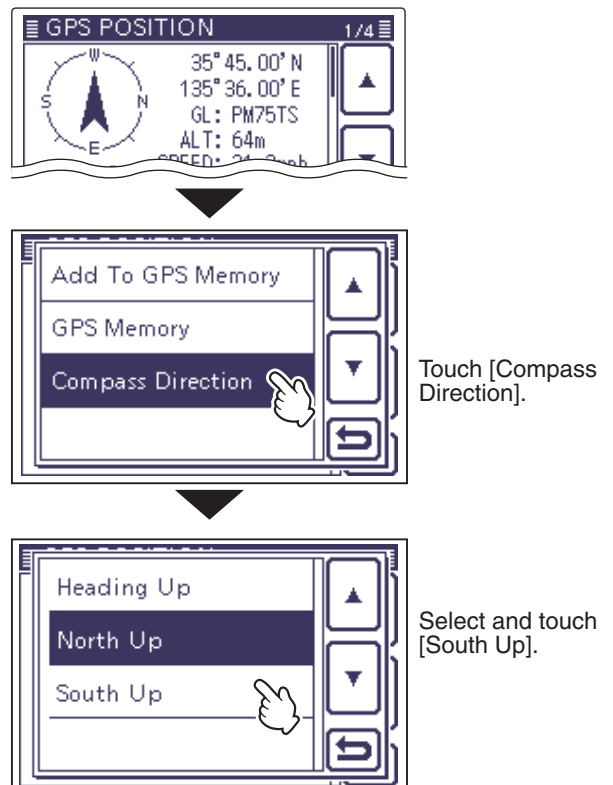



Checking GPS position (Continued)

◇ Saving your own or received position data

With this function, you can save the position information of your station from wherever you are, and also the position information of the station you received it from.

The GPS Memory is capable of storing 100 channels in total, assignable to one of 27 banks, A to Z.

- ① Push **QUICK**(C), and then touch "GPS Position."
- ② Touch **[▲]/[▼]**(D) to display the screen that you want to save between MY and RX.
  - To save the position information of your station, select MY.
  - To save the position information of the station you received from, select RX
- ③ Push **QUICK**(C).
- ④ Touch "Add To GPS Memory."
- ⑤ Touch **[▲]/[▼]**(D) to select <<Add Write>>, and touch "Yes."
  - The data is saved in the GPS memory and returns to the "GPS Position" screen.
  - The position information (Latitude/Longitude) is automatically added.
  - See pages 10-7 and 10-11 for details on editing.
- ⑥ Push **SET**(C) to exit the "GPS Position" screen.

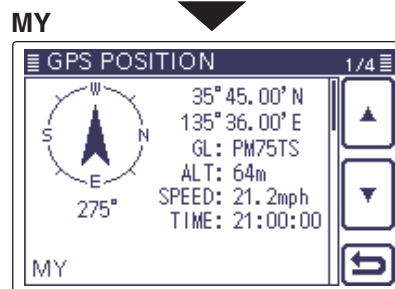
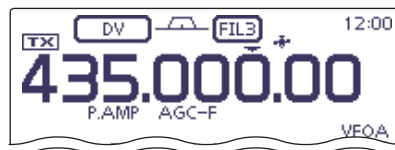

Select the **MY** screen to save your position.

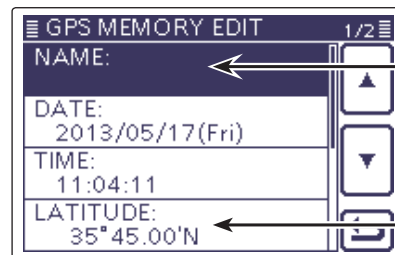

Touch a Memory contents title to edit. (Example: Name)  
GPS MEMORY EDIT screen is displayed, and Latitude/Longitude is added.

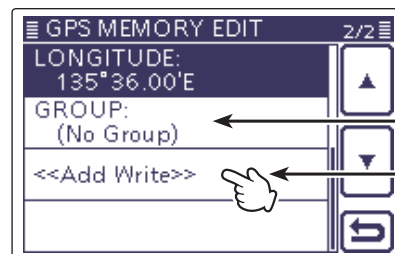

Select a destination group to save.  
Touch to save the edit.

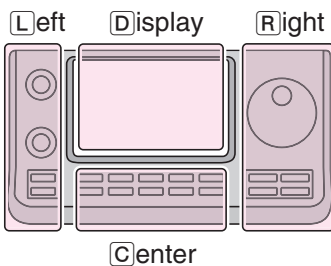
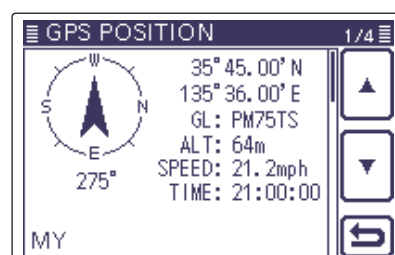

The L, R, C or D in the instructions indicate the part of the controller.

- L: Left side
- R: Right side
- C: Center bottom
- D: Display (Touch screen)

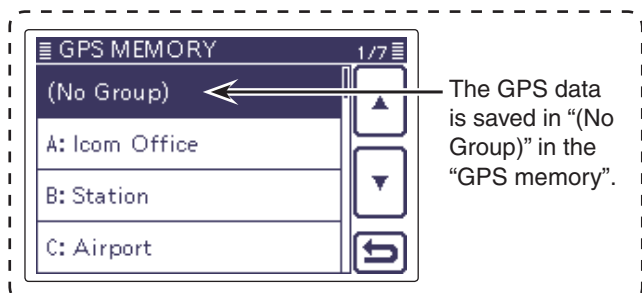

The GPS data is saved in "(No Group)" in the "GPS memory".

## Checking GPS information (Sky view screen)

This screen is used to receive GPS satellite information when the GPS indicator does not stop blinking for a long time.

GPS Information displays the quantity, signal power and position of the GPS satellites.

The sky view screen shows the position of GPS satellites. The screen also shows the direction, elevation angle, satellite numbers and their receiving signal strength status.

- ① Push **QUICK**(C).
- ② Touch **[▲]/[▼]**(D) to select "GPS Information."
  - The "GPS INFORMATION" screen is displayed.

### Meaning of each icon

- (○): Untracking satellite.
- (01): Tracking satellite with a weak signal shown by satellite number.
- (01): Tracking satellite with a strong signal shown by satellite number.
- (SAT): The quantity of tracking satellites.
- Altitude: The altitude of your station. The altitude is only displayed when more than 4 satellites are tracked. When less than 3 satellites are tracked, "-----ft" is displayed.
- Longitude/Latitude: Longitude and Latitude of your station.

- ③ Push **SET**(D) to exit the "GPS Information" screen.

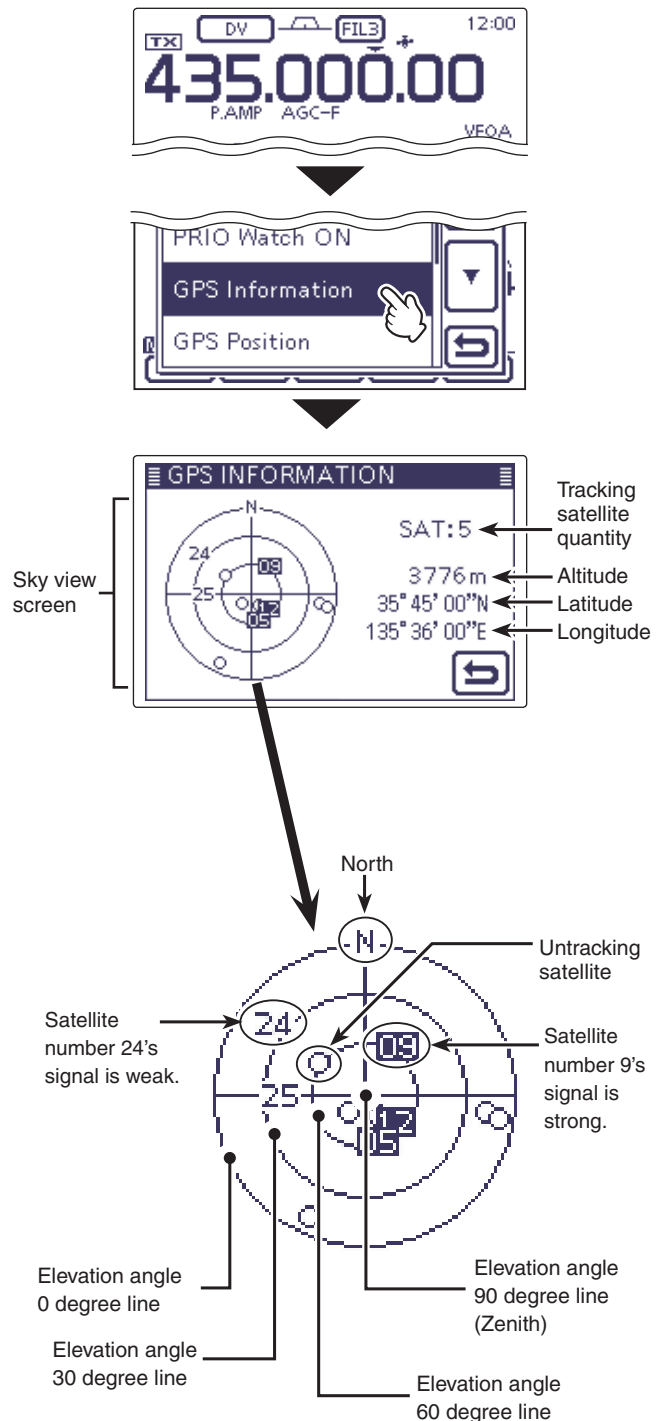
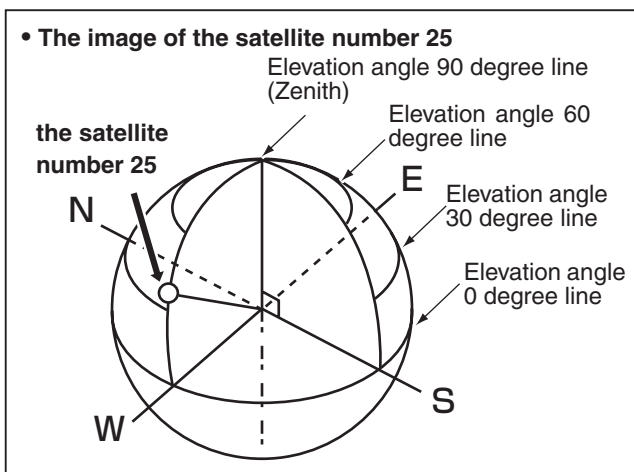

## Adding or editing GPS memory

### ◇ GPS memory

You can add GPS data to GPS Memory.  
You can add your own position, other station's positions or any positions that are manually programmed.

The GPS Memory is capable of storing a total of 100 channels, and conveniently stored in up to 27 groups, from A to Z and "(No Group)." The A to Z groups can also be named.

### ◇ Add a GPS memory

#### 1. Adding GPS Memory and entering the edit mode

- ① Push **SET**(C) to enter the Set mode.
- ② Touch the "GPS MEMORY" item of the "GPS" Set mode.  
GPS > **GPS Memory**
  - If the specified item is not displayed, touch [▲] or [▼](D) one or more times to select the page.
  - All the previously added GPS memories are displayed.
- ③ Touch "(No Group)."
- ④ Push **QUICK**(C).
- ⑤ Touch "Add" to display the "GPS MEMORY EDIT" screen.

(Continued on the next page)

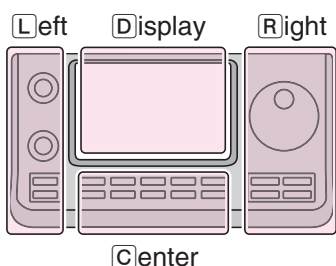
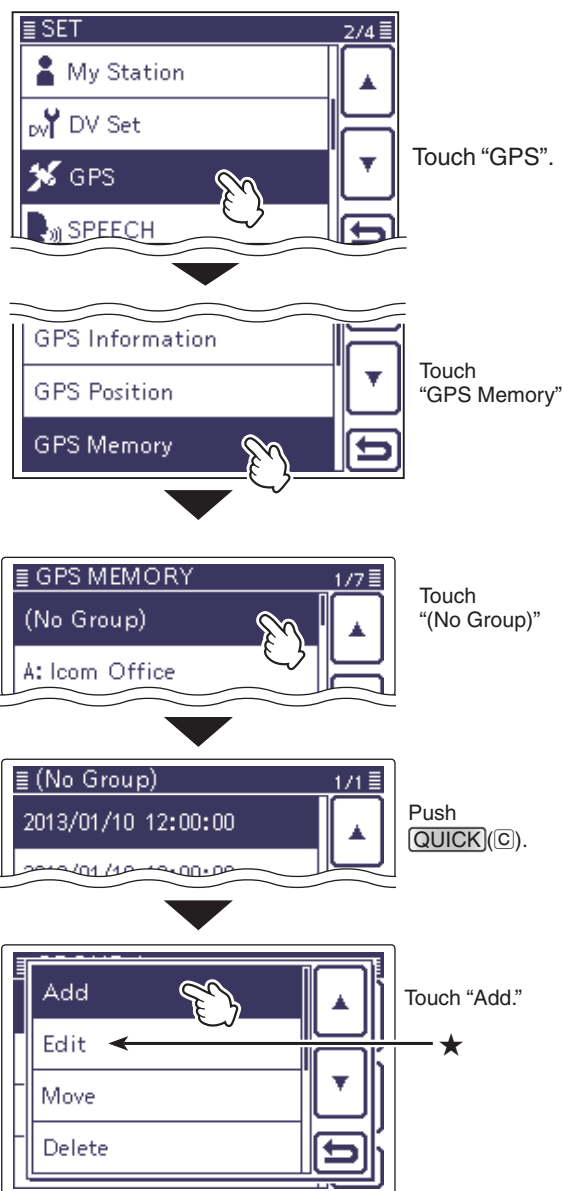
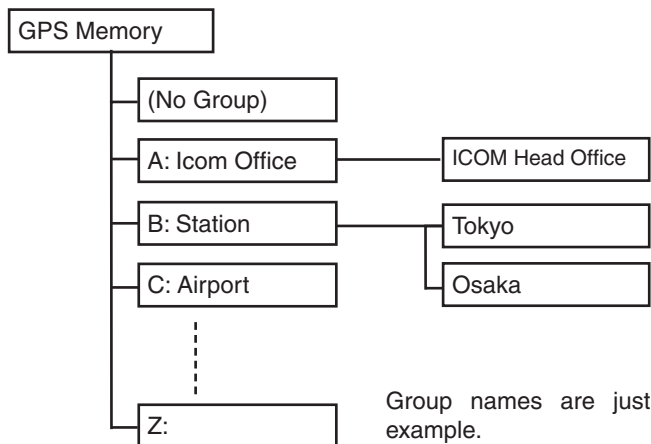

The L, R, C or D in the instructions indicate the part of the controller.

- L: Left side
- R: Right side
- C: Center bottom
- D: Display (Touch screen)

★ "Edit" is selected when you wish to edit the previously stored GPS memory. You enter the Edit mode in the same way as adding.

**Adding or editing GPS memory (Continued)**

◇ Add a GPS memory (Continued)

**2. GPS Memory name programming**

⑥ Touch [NAME:] to enter the name programming mode.

⑦ Enter the name touching the desired block one or more times to select the desired character, number or symbol.

Selectable characters and symbols
A to Z, a to z, 0 to 9, ! # \$ % & \ ? " ' ` ^ + - * / . , ; = < > ( ) [ ] { }   _ ` @ (space)

- Touch "AB↔12" to toggle between the Alphabet input and Number input mode.
- Touch [CLR](D) to delete the selected character, symbol or number.
- Touch [ [AB] ](D) to open the input mode selection window.
- Touch "\_" to input a space.

⑧ Touch [←](D) or [→](D) to move the cursor backward and forward.

⑨ Repeat steps ⑦ and ⑧ to program up to 16 characters of a GPS memory name (space included).

⑩ Touch [ENT](D) when the programming is completed.

- Returns to the "GPS MEMORY EDIT" screen.

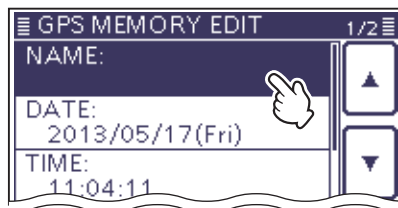

Touch "NAME:"

**Name programming**

- Moves the cursor.
- Clears a character.
- Open an input mode window
- Touch after entering.
- Space
- Cancels and returns to the previous screen.

**Input mode selection window**

Touch "ab" to select the lower case letters.

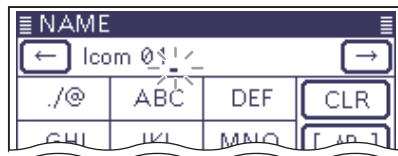

Example; "Icom 01" is entered.

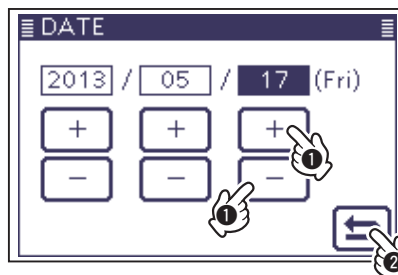

**3. GPS Memory date programming**

⑪ Touch "DATE:" to enter the date programming mode.

⑫ Touch or hold down [+] or [-](D) under the changing subject between Year, Month, and Day to program the date.

- You can also change by using the dial.
- From 2000/01/02 to 2099/12/30 can be programmed.

⑬ When the programming is completed, touch [↵](D) to return to the "GPS MEMORY EDIT" screen.

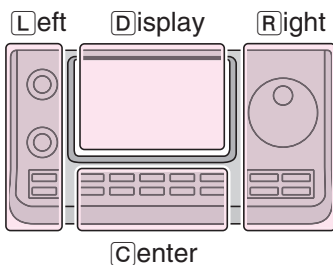

The L, R, C or D in the instructions indicate the part of the controller.

- L: Left side
- R: Right side
- C: Center bottom
- D: Display (Touch screen)

**Adding or editing GPS memory (Continued)**

**4. GPS memory time programming**

- ⑭ Touch "TIME:" to enter the time programming mode.
- ⑮ Touch or hold down [+] or [-] under the changing subject between Hour, Minute, and Second to program the time.
  - You can also change by using the dial.
  - From 00:00:00 to 23:59:59 can be programmed.
- ⑯ When the programming is completed, touch [↵](D) to return to the "GPS MEMORY EDIT" screen.

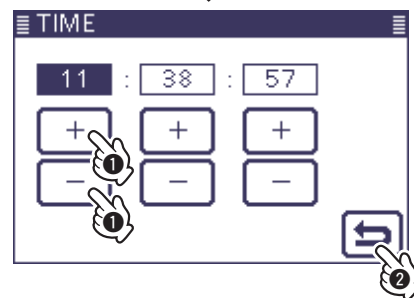
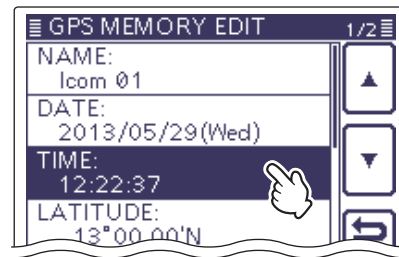

**5. GPS latitude programming**

- ⑰ Touch "LATITUDE:" to enter the latitude programming mode.
- ⑱ Enter the desired latitude using the touch screen
  - From 0°00.00' to 90°00.00' can be programmed.
  - If "ddd° mm' ss'" is selected in "Position Format" screen, between 0°00'00" to 90°00'00" are programmable.

GPS > GPS Set > **Position Format**
- ⑲ Touch [←](D) or [→](D) to move the cursor backward and forward.
  - Touch "N/S" to select "N" to program the north latitude, and "S" to program the South latitude.
- ⑳ Repeat steps ⑱ and ⑲ to program the latitude.
- ㉑ When programming is completed, touch [ENT](D) to return to the "GPS MEMORY EDIT" screen.

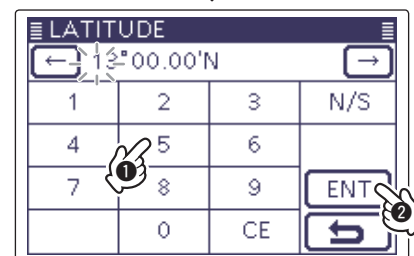
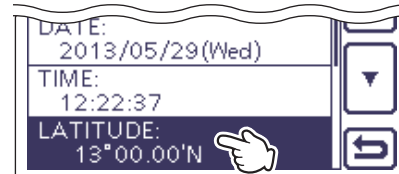

**6. GPS longitude programming**

- ㉒ Touch "LONGITUDE:" to enter the longitude programming mode.
- ㉓ Enter the desired longitude using the touch screen.
  - From 0°00.00' to 180°00.00' can be programmed.
  - If "ddd° mm' ss'" is selected in "Position Format" screen, between 0°00'00" to 180°00'00" are programmable.

GPS > GPS Set > **Position Format**
- ㉔ Touch [←](D) or [→](D) to move the cursor backward and forward.
  - Touch "E/W" to select "E" to program the East longitude, and "W" to program the West longitude.
- ㉕ Repeat steps ㉓ and ㉔ to program the longitude.
- ㉖ When programming is completed, touch [ENT](D) to return to the "GPS MEMORY EDIT" screen.

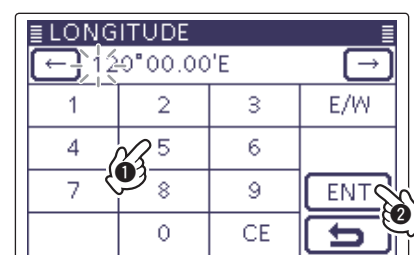
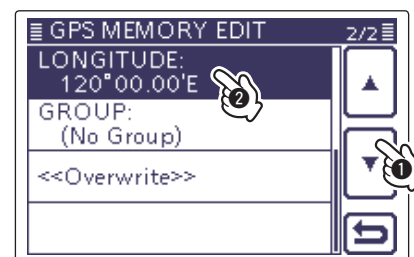

**Adding or editing GPS memory (Continued)**

**7. GPS memory group programming**

- ⑳ Touch "GROUP:" to enter the group programming mode.
- ㉑ Touch the desired group between (No Group) or A to Z.
  - When the group is selected, automatically returns to the "GPS MEMORY EDIT" screen.
  - A total of up to 100 memories can be stored.

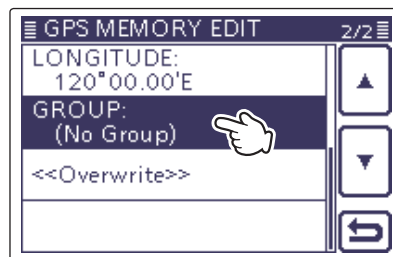

**8. Writing GPS memory**

- ㉒ Touch "<<Add Write>>," and then touch [YES](D) to write the programmed GPS memory.
  - If a previously added GPS memory is edited, select "<<Overwrite>>."
  - The data is added to the GPS memory, and then displays its data screen.

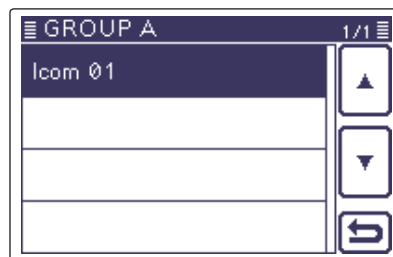
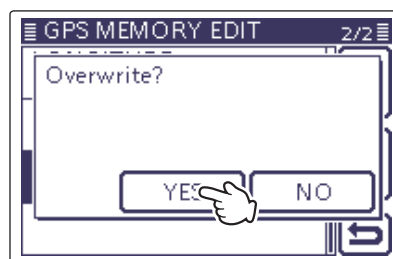
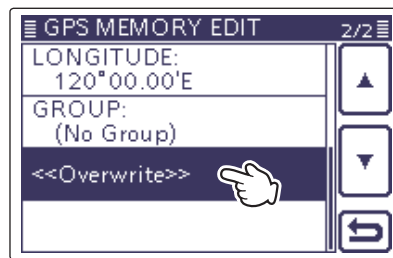
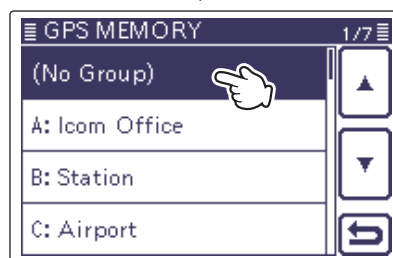

**To cancel the programming data:**

To cancel the programmed data, push [SET](C) to display the "Cancel edit?" screen.

Touch [YES](D) to cancel programming and the display returns to the GPS Memory channel screen.

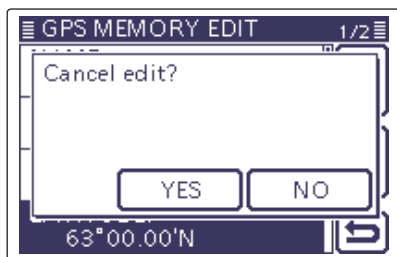

**Adding or editing GPS memory (Continued)**

**◇ GPS group name programming**

You can register the name of each GPS group.

- ① Push **SET**(C) to enter the Set mode.
- ② Touch the "GPS MEMORY" item of the "GPS" Set mode.  
GPS > **GPS Memory**
  - If the specified item is not displayed, touch **▲** or **▼**(D) one or more times to select the page.
- ③ Touch the desired group for 1 second to edit between group "A" to "Z."
- ④ Touch "Edit Name."  
• The "GROUP NAME" screen is displayed to edit the group name.
- ⑤ Enter the name touching the desired block one or more times to select the desired character, number or symbol.
  - Touch "AB↔12" to toggle between the Alphabet input and number input mode.
  - Touch [ **AB** ] and select "ab" to enter the lower case letters.
  - Touch **CLR**(D) to delete the selected character, symbol or number.
  - Touch " " to input a space.
- ⑥ Touch **←**(D) or **→**(D) to move the cursor backward and forward.
- ⑦ Repeat steps ⑤ and ⑥ to program up to 16 characters of a GPS group name (space included).
- ⑧ Touch **ENT**(D) when the programming is completed.
  - Returns to the "GPS MEMORY" screen.

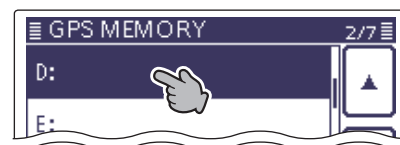

Touch for 1 second.



**Name programming**

- ← Moves the cursor.
- ← Clears a character.
- ← Character type selection.
- ← Touch after entering.
- ← Cancels and returns to the previous screen.
- ← Space

**Character type selection screen**

Touch [ab] to select the lower case letters.

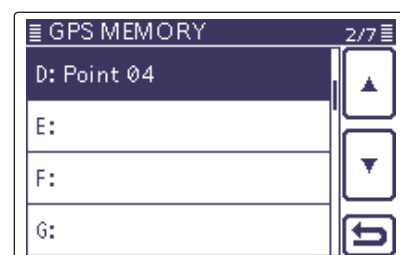

Example; "Point 04" is entered.

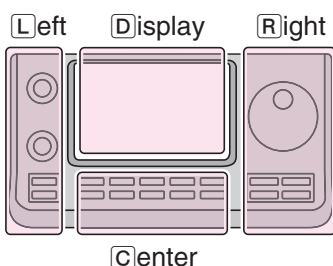

The **L**, **R**, **C** or **D** in the instructions indicate the part of the controller.

- L**: Left side
- R**: Right side
- C**: Center bottom
- D**: Display (Touch screen)



**Adding or editing GPS memory (Continued)**

**◇ Clearing a GPS data**

GPS memories can be cleared (erased). Please note that erased GPS memories cannot be restored.

There are two ways to clear the memories;

- Erasing all GPS memory in a group.
- Erasing a specific memory channel.

**Example:  
Erasing all in the “(No Group).”**

- ① Push **SET**(C) to enter the Set mode.
- ② Touch the “GPS MEMORY” item of the “GPS” Set mode.  
GPS > **GPS Memory**
  - If the specified item is not displayed, touch [▲] or [▼](D) one or more times to select the page.
- ③ Touch the desired group for 1 second to select.
- ④ Touch “Delete All In Group.”
  - The confirm screen “Delete all in group?” appears.
  - Touch [YES](D) to clear.
  - The selected GPS memory is cleared, and then returns to the “GPS MEMORY” screen.

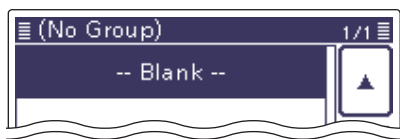

All GPS memory in the group is cleared.

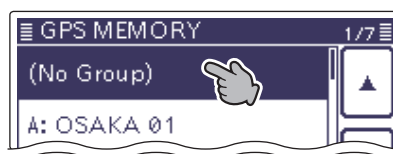
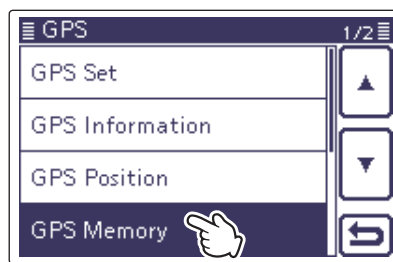

Touch for 1 second.

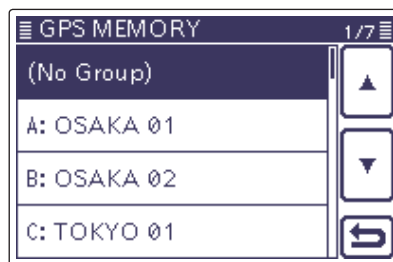

**Deleting a specific GPS memory channel**

GPS memories can be deleted.

- ① Touch to select the memory group where the desired GPS memory to delete is located, as illustrated below. (Example: B: OSAKA 02)

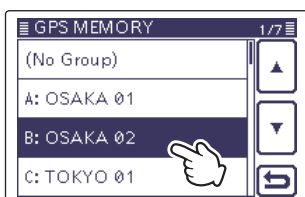

Touch to select the memory group.

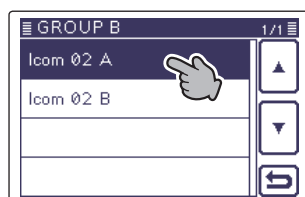

Touch for 1 second to select the memory channel.

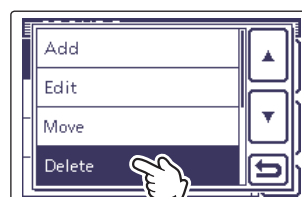

Touch “Delete.”

- ② Touch the desired GPS memory for 1 second. (Example: Icom 02 A)
- ③ Touch “Delete,” and then [YES](D) to delete.
  - The selected GPS memory channel is deleted.

**Adding or editing GPS memory (Continued)**

**◇ Moving a GPS data**

You can move programmed GPS memories to rearrange their display order in the selected GPS memory group.  
 In order to move the GPS memory out of their assigned memory group, edit and move, and then save.

- ① Push **SET**(**C**) to enter the Set mode.
- ② Touch the "GPS MEMORY" item of the "GPS" Set mode.  
**GPS > GPS Memory**
  - If the specified item is not displayed, touch [**▲**] or [**▼**](**D**) one or more times to select the page.
- ③ Touch the group where the desired GPS memory to move is stored.
- ④ Touch the desired GPS memory for 1 second to move.  
 Example: Icom 02
- ⑤ Touch "Move" and the "DESTINATION" screen displays.
- ⑥ Select and touch between a GPS memory destination or "<<Move End>>".
  - If a GPS memory is touched, the desired memory is moved up one position.
  - If "<<Move End>>" is touched, the desired memory is moved to the bottom of the group.

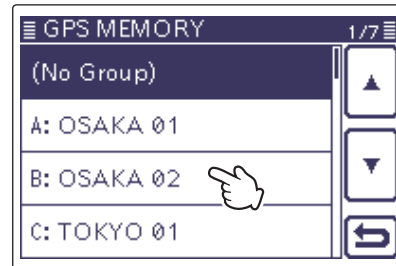
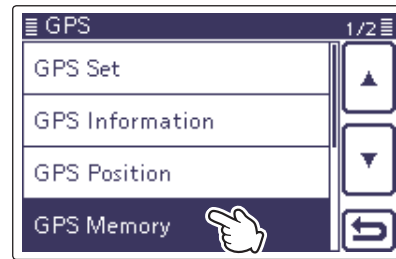

Touch to select the memory group.



Hold down the memory to move.

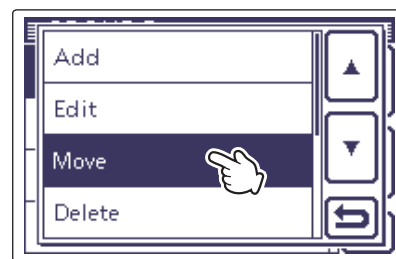

Touch "Move."

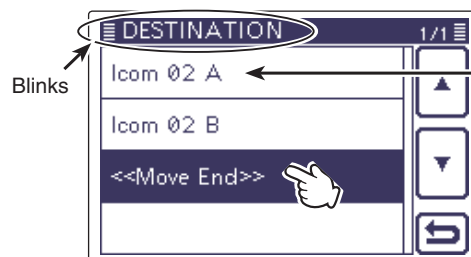

Before the move.

Select the destination.

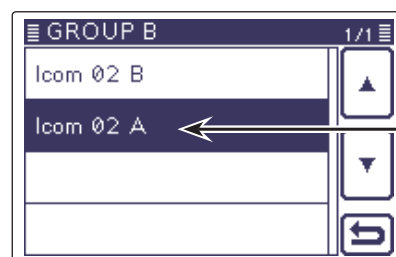

After the move.

"Icom 02 A" is moved to the bottom.

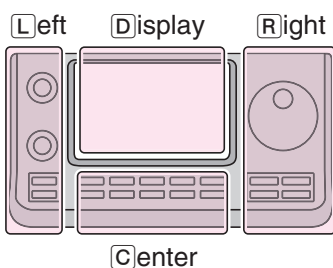

The **L**, **R**, **C** or **D** in the instructions indicate the part of the controller.

- L**: Left side
- R**: Right side
- C**: Center bottom
- D**: Display (Touch screen)

Adding or editing GPS memory (Continued)

◇ GPS alarm setting

A GPS alarm can sound when a target position comes into the alarm area.

This function can be set to the caller station, all GPS Memory channels, a specified Memory group or a specified Memory channel.

**Alarm area 1 (Setting plural stations)**

When all channels or group is selected:

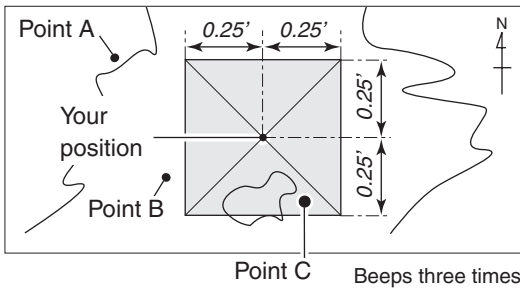

**Alarm area 2 (Setting specific station)**

When a specified memory is selected:

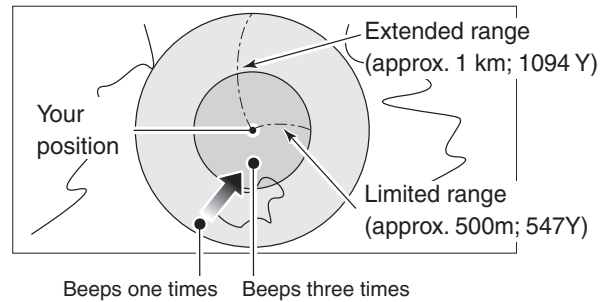

**Example: Alarm area (Group)**

- ① Push **SET**(**C**) to enter the Set mode.
- ② Touch the "GPS ALARM" item of the "GPS" Set mode.  
GPS > **GPS Alarm**
  - If the specified item is not displayed, touch **▲** or **▼**(**D**) one or more times to select the page.
- ③ Touch "Alarm Select."
- ④ Touch "Group," and then "All Memories."  
  - If you want to set the alarm to a GPS memory group, touch "(No Group)" or "A" to "Z."
- ⑤ Push **SET**(**C**) to exit the Set mode.
  - When either one of the stations in a specified group enters the set range, the beep sounds three times.
  - When the GPS alarm beeps, "GPS ALARM" pops up on the screen and then the "📶" icon blinks.
  - To cancel the GPS alarm, repeat step ④ and select "Alarm OFF."

**NOTE:** When "All Memories", "A" to "Z" or "(No Group)" is selected, the alarm sounds depend on the "Alarm Area (Group)" setting in the Set mode.

GPS > GPS Alarm > **Alarm Area (Group)**

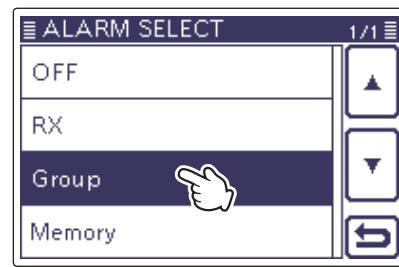

Touch "Group."



Touch "All Memories."

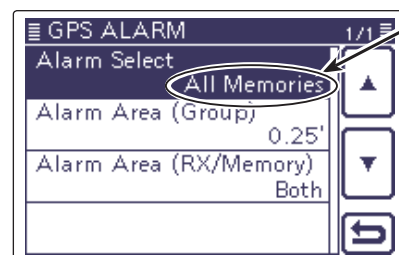

"All Memories" is displayed

**GPS beeping screen**

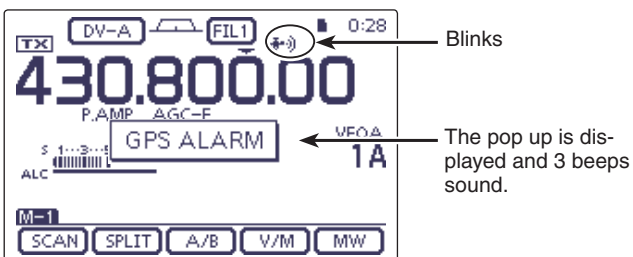

**Adding or editing GPS memory (Continued)**

◇ GPS alarm setting (Continued)

**Example:** Alarm area (RX/Memory)  
Alarm Setting is set to RX.

- ① Push **SET**(**C**) to enter the Set mode.
- ② Touch the “GPS ALARM” item of the “GPS” Set mode.  
GPS > **GPS Alarm**
  - If the specified item is not displayed, touch **[▲]** or **[▼]**(**D**) one or more times to select the page.
- ③ Touch “Alarm Select.”
- ④ Touch “RX.”
  - If you want to set the alarm to a GPS memory channel, touch “Memory,” and then touch “(No Group)” or “A” to “Z.”
- ⑤ Push **SET**(**C**) to exit the Set mode.
  - When a station with its GPS alarm set enters within an approximate 1 kilometer (1093 yard) range, the beep sounds once. When it enters within an approximate 500 meter (546 yard) range, a beep sounds three times.
  - When the GPS alarm beeps, “GPS ALARM” pops up on the screen and then the “

**NOTE:**

- When “RX” or a GPS memory channel is selected, the alarm sounds depending on the “Alarm Area (RX/Memory)” setting in the Set mode.  
GPS > GPS Alarm > **Alarm Area (RX/Memory)**
- Even if “RX” is selected in step ④, and the received signal has no position, the GPS alarm does not sound.

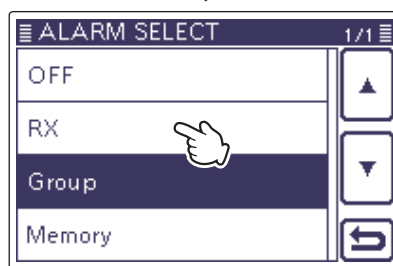
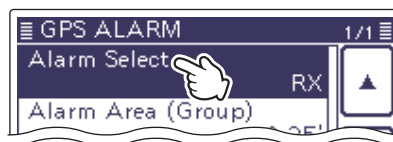

Touch “RX.”

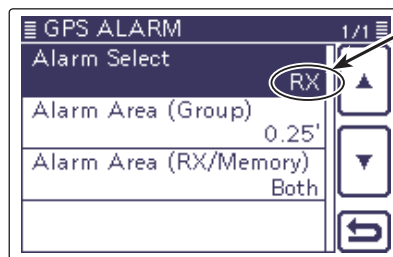

“RX” is displayed.

**GPS beeping screen**

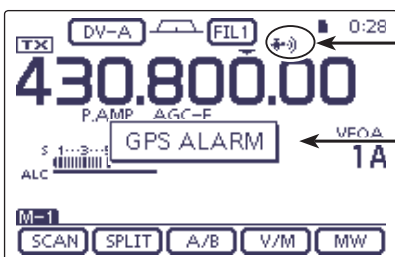

Blinks

The pop up is displayed and beeps sound, depending on the setting of the alarm area.

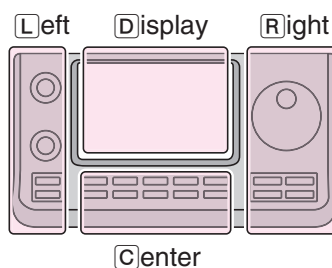

The **L**, **R**, **C** or **D** in the instructions indicate the part of the controller.

- L**: Left side
- R**: Right side
- C**: Center bottom
- D**: Display (Touch screen)

## Transmitting GPS data

Set a GPS sentence to transmit GPS data in the DV mode.

### ◇ GPS data sentence setting

- ① Push **SET**(**C**) to enter the Set mode.
- ② Touch the “GPS TX Mode” item of the “GPS” Set mode.  
GPS > **GPS TX Mode**
  - If the specified item is not displayed, touch [**▲**] or [**▼**](**D**) one or more times to select the page.
- ③ Touch “GPS(DV-G).”
- ④ Touch “GPS Sentence” to display the “GPS Sentence” screen.
- ⑤ Touch the desired GPS sentence.
  - Touching “✓” cancels the setting.
  - The selectable GPS sentences are RMC, GGA, GLL, VTG, GSA and GSV. The GGA sentence is set to ON as the default GPS sentence.
  - Push **QUICK**(**C**), and then touch [Default] to set the GPS sentence as the default.
- ⑥ Repeat step ⑤ to set the GPS sentence.
  - A maximum of 4 GPS sentences can be set at a time.
- ⑦ Push **SET**(**C**) to exit the Set mode.

### NOTE:

- Set the GSV sentence to OFF when sending the GPS message to conventional digital transceivers (IC-2820H, IC-E2820, ID-800H, IC-91AD, IC-E91, IC-V82, IC-U82, IC-2200H, ID-1).  
The GSV sentence is incompatible with them.
- If “Manual” is selected in the GPS select, the GPS sentence is artificially selected and transmitted, according to the manually set position data in “Manual Position.”  
GPS > GPS Set > **Manual Position**
- Please note that if “GPS Auto TX” is set to any other setting than “OFF,” the data is automatically transmitted according to the set time.  
GPS > **GPS Auto TX**

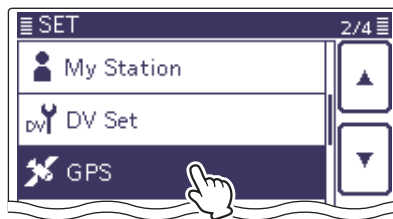

Touch [GPS].

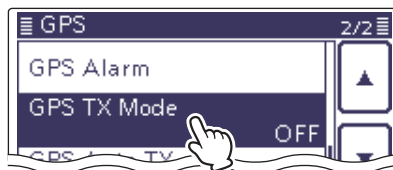

Touch “GPS TX Mode.”

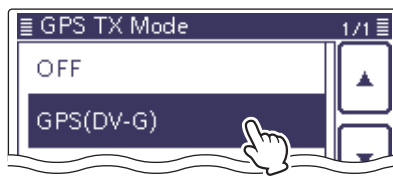

Touch “GPS(DV-G).”

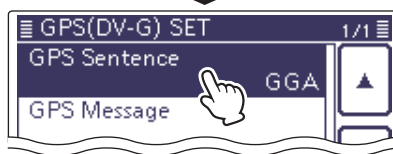

Touch “GPS Sentence.”

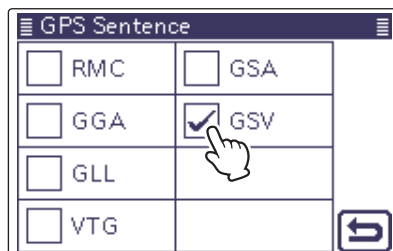

Touch the desired sentence to set.

### • The display while transmitting GPS (DV-G)

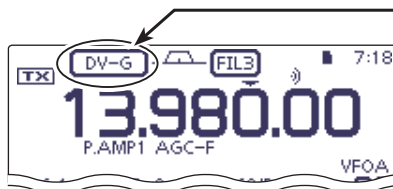

“DV-G” appears if “GPS (DV-G)” is selected in the DV Mode.

When transmitted, the set GPS sentence is transmitted.

### • Contents of GPS sentence

Sentence	Lon /Lat	Alt	UTC	Date (UTC)	Status	2D /3D	COG (True)	SOG (knot)	Others
RMC	✓		✓	✓	✓				Mode Indicator,
GGA	✓	✓	✓		✓				Number of satellites in use, HDOP, Geoidal separation, Age of Differential GPS data
GLL	✓		✓		✓				Mode Indicator
VTG							✓	✓	COG (Magnetic north), SOG (km/h), Mode Indicator
GSA					✓	✓			ID numbers of satellites used in solution, PDOP, HDOP, VDOP
GSV									Total number of sentences, Sentence number, Total number of satellites in view, Satellite information (ID, Elevation, Azimuth, S/N)

GPS transmitting data (Continued)

◇ GPS message programming

Enter a GPS message of up to 20 characters to be transmitted with the position data.

**Example:** Adding “HELLO HOW ARE YOU?”

- ① Push **SET**(C) to enter the Set mode.
- ② Touch the “GPS TX Mode” item of the “GPS” Set mode.  
GPS > **GPS TX Mode**
  - If the specified item is not displayed, touch [▲] or [▼](D) one or more times to select the page.
- ③ Touch “GPS(DV-G).”
- ④ Touch “GPS Message” to display the “GPS Message” screen.
- ⑤ Touch and hold the “GPS Message” screen for 1 second to display the “Edit” and “Clear” selecting screen.
  - Pushing **QUICK**(C) also displays the screen.
- ⑥ Touch “Edit” to display the GPS message editing screen.
- ⑦ Enter the name touching the desired block one or more times to select the desired character, number or symbol.
  - Touch “AB⇄12” to toggle between the Alphabet input and number input mode.
  - Touch [ [AB] ] and select “ab” to enter the lower case letters.
  - Touch **CLR**(D) to delete the selected character, symbol or number.
  - Touch “\_” to input a space.
- ⑧ Touch [←](D) or [→](D) to move the cursor backward and forward.
- ⑨ Repeat steps ⑦ and ⑧ to program up to 20 characters of a GPS message (space included).
- ⑩ Touch **ENT**(D) when the programming is completed.
  - Returns to the “GPS Message” screen.
- ⑪ Push **SET**(C) to exit the Set mode.

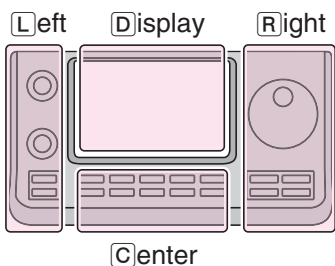
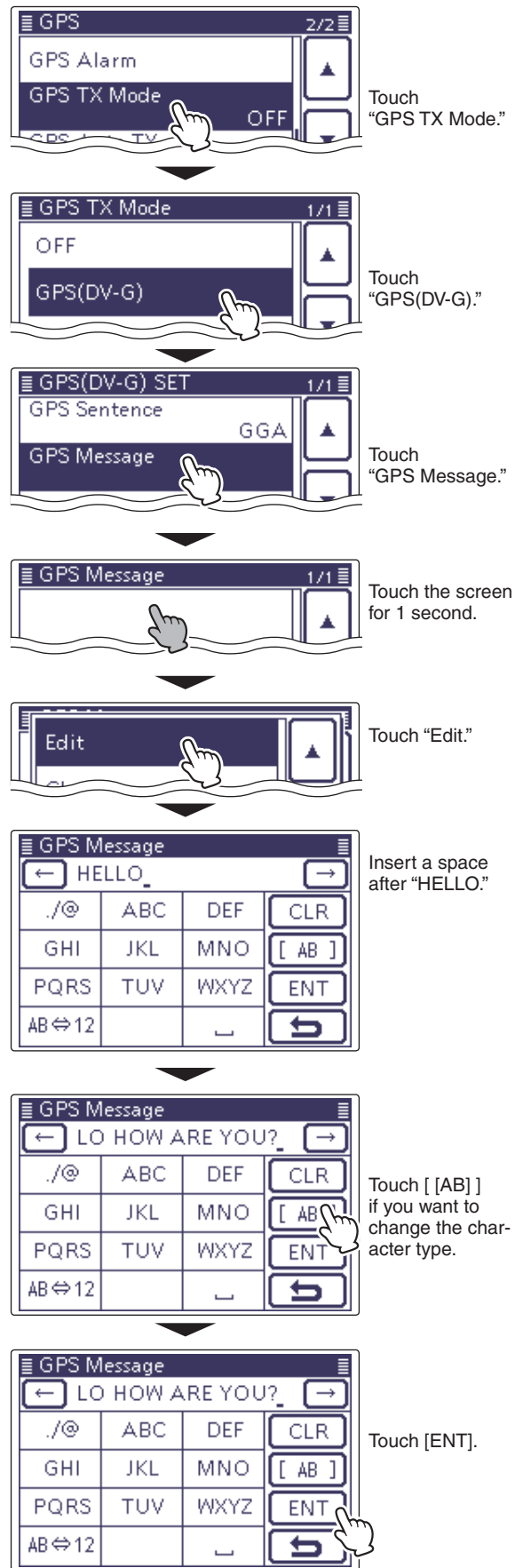

The L, R, C or D in the instructions indicate the part of the controller.

- L: Left side
- R: Right side
- C: Center bottom
- D: Display (Touch screen)

## Transmitting GPS-A data

GPS-A mode is an operating mode supported with the D-PRS to transmit position data.

In GPS-A operation, the following codes are transmitted to the PC connected to the IC-7100.

GPS-A code is based on APRS® code.

(APRS® : Automatic Packet Reporting System).

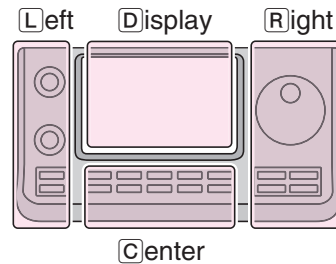

The L, R, C or D in the instructions indicate the part of the controller.

- L: Left side
- R: Right side
- C: Center bottom
- D: Display (Touch screen)

### About GPS-A data

GPS-A data is formatted as shown below.

(e.g.) JA3YUA>API710,DSTAR\*/002338h3437.38N/13534.29E>000/000/A=000000Who are you?

- |                      |               |                      |                          |
|----------------------|---------------|----------------------|--------------------------|
| ① Your own call sign | ③ Time stamp* | ⑤ GPS-A symbol (Car) | ⑦ Data extension         |
| ② Unproto address    | ④ Latitude    | ⑥ Longitude          | ⑧ GPS-A comment/Altitude |

\*h: "hhmmss", z: "ddhhmm"

- The UTC time is used.
- The data from the internal or external GPS is used.

### ◇ D-PRS

D-PRS is a function which simultaneously sends position data received from the internal or external GPS receiver, using the slow speed data packet space, along with voice in the DV mode.

In the analog format you can transmit or receive only voice or data at one time. However a D-PRS capable radio can transmit or receive message data or GPS position data at the same time voice is been transmitted or received.

#### • The image of D-PRS

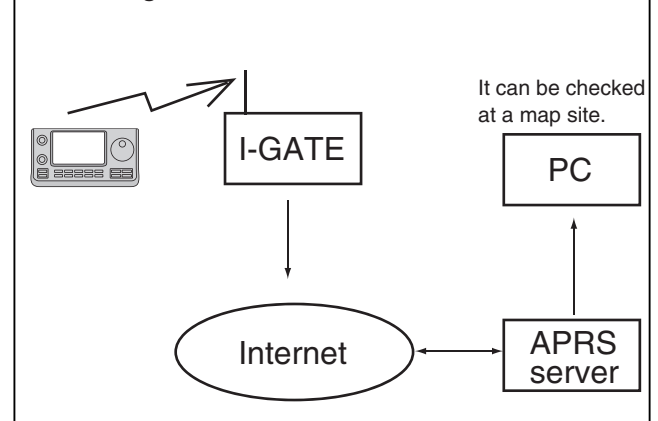

### ◇ Operating GPS-A

To transmit in GPS-A, follow the steps below, and for more details, see the pages listed along with the steps.

1. "MY"(Your own call sign) programming (p. 7-2)
2. Receiving GPS data (p. 10-2)
3. Set GPS TX MODE to GPS-A (p. 10-16)
4. Transmitting GPS-A data setting (pp. 10-18 to 10-22)



Setting is completed.  
(Transmission is enabled in GPS-A)

#### NOTE:

• If "Manual" is selected in the GPS select screen, the processed GPS-A code is transmitted according to the manually set position data in "Manual Position." (p. 10-2)

GPS > GPS Set > **Manual Position**

• Please note that if "GPS Auto TX" is set to any other setting than "OFF," the data is transmitted according to the setting time. (p. 10-22)

GPS > **GPS Auto TX**



Transmitting GPS-A data (Continued)

◇ **Setting GPS-A**

Set to transmit in the GPS-A mode.

**1. Setting GPS-A in the GPS TX Mode**

- ① Push **SET**(**C**) to enter the Set mode.
- ② Touch the "GPS TX Mode" item of the "GPS" Set mode.  
GPS > **GPS TX Mode**
  - If the specified item is not displayed, touch **[▲]** or **[▼]**(**D**) one or more times to select the page.
- ③ Touch "GPS-A(DV-A)."

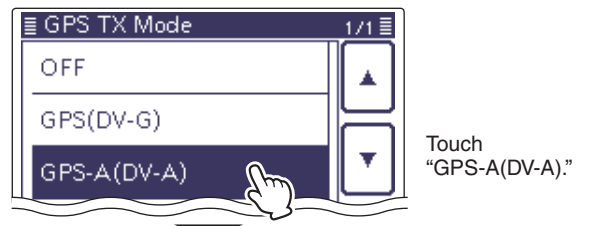
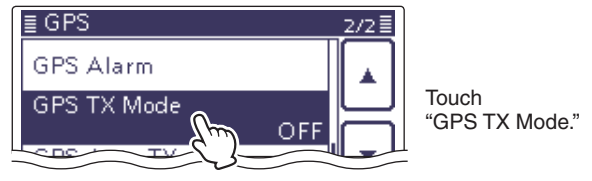

**2. Unproto Address Display**

The default address should be used, and editing is not recommended.

- ④ Touch "Unproto Address."  
• The default setting is "API710,DSTAR\*"
- ⑤ Touch **[↵]**(**D**) to return to the previous screen.



**3. Setting Data Extension**

Set the data extension of your station's course direction and speed information.

- ⑥ Touch "Data Extension."
- ⑦ Touch "Course/Speed."



**4. Setting Time Stamp**

Set the time stamp function to transmit the received time data in UTC (Universal Time Coordinated) time.

- ⑧ Touch "Time Stamp."
- ⑨ Select and touch the desired time stamp to set.
  - OFF** : Does not transmit the time information.
  - DHM** : Transmits the time stamp in the Day, Hour, and Minute format.
  - HMS** : Transmits the time stamp in the Hour, Minute, and Second format.



**5. Setting Altitude**

Set the altitude data transmission.

- ⑩ Touch "Altitude."
- ⑪ Touch "ON."

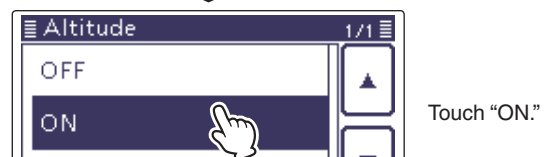

**NOTE:**

If you transmit with the altitude setting ON, to those products that are not capable of displaying the altitude (IC-9100, IC-80AD, IC-E80D, ID-880H, ID-E880, IC-92AD, IC-E92D), the characters appear as a comment.

(Continued on the next page)

Transmitting GPS-A data (Continued)

**6. Setting GPS-A Symbol**

Select the desired GPS-A symbol that represents your operating situation.

The selected GPS-A symbol channel's symbols (1~4) are transmitted along with the position data.

- ⑫ Touch [▲]/[▼](D) to change the GPS-A (DV-A) setting page.
- ⑬ Touch "GPS-A Symbol."
- ⑭ Select and touch the desired symbol between 1:House, 2: Car, 3: Van, and 4:Truck.
  - If you wish to use any GPS-A symbol or previously saved symbol, touch the desired symbol for 1 second.
  - Pushing QUICK(C) also displays the screen.
  - Touch "Edit Symbol," then [▲]/[▼](D) and the desired symbol to edit.
  - Touch a symbol for 1 second to select the [Direct Input] mode, and other symbols are also selectable.



Touch "GPS-A Symbol."

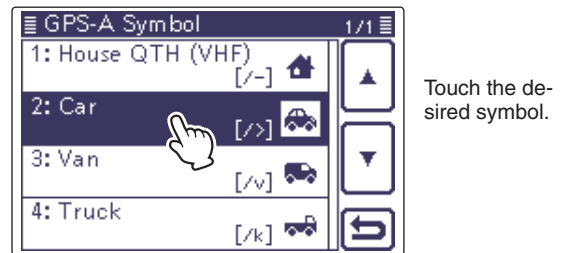

Touch the desired symbol.

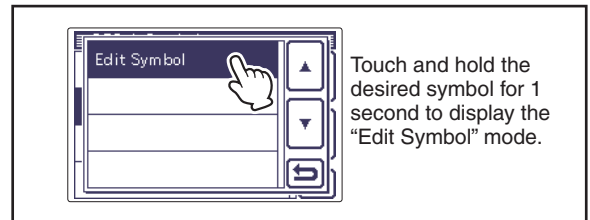

Touch and hold the desired symbol for 1 second to display the "Edit Symbol" mode.

**7. Setting SSID**

To assist in identifying a station's type, the displayed APRS® (Automatic Packet Reporting System) based SSID is added after the GPS-A data call sign.

The way to add SSID's differs, depending on whether if you enter a space in your call signs or not.

- ⑮ Touch "SSID."
- ⑯ Touch the desired SSID to set.
  - [▲]/[▼](D) changes the SSID setting page.
  - ---: Change the space in call sign to "-". If the space is the last character, delete the space instead of changing it to a "-".  
Example: JA3YUA A > JA3YUA-A
  - (-0): No SSID. If you use a capital letter, it will be deleted.
  - -1~-15: Adds an SSID of -1 to -15 to your call sign.  
Example: "-9" is entered  
JA3YUA A > JA3YUA-9
  - -A~-Z: Adds an SSID of -A to -Z to your call sign.  
Example: "-Z" is entered  
JA3YUA A > JA3YUA-Z



Touch "SSID."

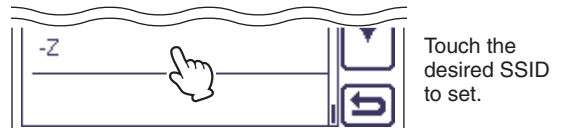

Touch the desired SSID to set.

**About SSID**  
 To assist in identifying a station's type, designated call sign SSIDs are used in D-PRS (APRS®), according to the common guideline.  
 The guideline may be changed when the infrastructure environment, such as a product or network, is changed.  
 Please check the latest guideline in the web site related on the D-PRS or APRS®, and correctly set.

(Continued on the next page)

Transmitting GPS-A data (Continued)

8. Comment programming

Program your comment and transmit it with the GPS-A position data.

The number of characters you can enter differs, depending on the settings of data extension and altitude (p. 10-19).

Data Extension	Altitude	The number of characters
OFF	OFF	less than 43 (Default)
OFF	ON	less than 35
Course/Speed	OFF	less than 36
Course/Speed	ON	less than 28

- ⑰ Touch "Comment."
- ⑱ Touch the displayed screen for 1 second.
  - Pushing **QUICK**(C) also displays the screen.
- ⑲ Touch "Edit" to display the "Comment" (Comment editing mode) screen.
- ⑳ Enter the name by touching the desired block one or more times to select the desired character, number or symbol.
  - Touch "AB↔12" to toggle between the Alphabet input and number input mode.
  - Touch [ [AB] ] and select "ab" to enter the lower-case letters.
  - Touch [CLR](D) to delete the selected character, symbol or number.
  - Touch " \_ " to enter a space.
- ㉑ Touch [←](D) or [→](D) to move the cursor backward and forward.
- ㉒ Repeat steps ⑳ and ㉑ to program a comment.
- ㉓ Touch [ENT](D) when the programming is completed.
  - Returns to the "Comment" screen.
- ㉔ Touch [↵](D) to return to the previous screen.

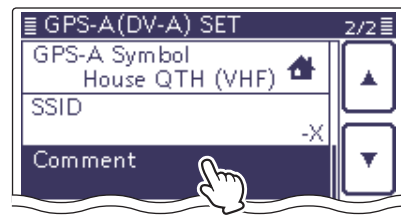

Touch "Comment."

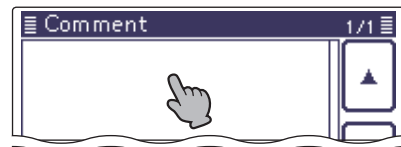

Touch the "Comment" screen for 1 second.

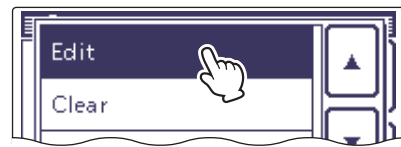

Touch "Edit."

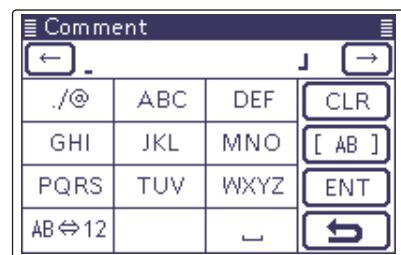

Enter a comment.

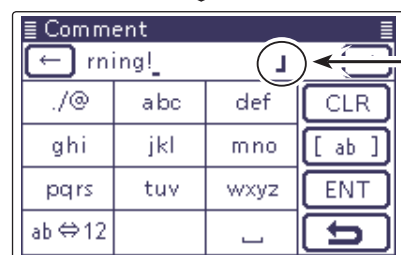

Ending icon

◇ Displaying your position using a mapping software

If you transmit to an I-GATE station, then enter the **call sign** information on the internet map website, the set GPS-A symbol is displayed.



## GPS Auto transmission for only Simplex

In the DV mode, this function automatically transmits the GPS receiver's current position data, at a selected interval, and should only be used in Simplex transmission.

**NOTE:**

- Your own **call sign** must be entered to activate the GPS automatic transmission.
  - When the "GPS Select" item on page 10-2 is set to "OFF" or "Manual," this function is disabled.
- GPS > GPS Set > **GPS Select**

### ◇ Setting the GPS automatic transmission

- ① Push **SET**(C) to enter the Set mode.
- ② Touch the "GPS Auto TX" item of the "GPS" Set mode.  
GPS > **GPS Auto TX**
  - If the specified item is not displayed, touch [▲] or [▼](D) one or more times to select the page.
- ③ Touch to select the desired position transmit interval between OFF, 5\*, 10, 30 seconds, or 1, 3, 5, 10, and 30 minutes.
  - If four GPS sentences are selected in GPS Sentence menu on page 10-16, "5sec" cannot be selected.
  - Selecting "OFF" cancels the GPS automatic transmission.
  - The GPS message is also transmitted, if programmed.
- ④ Push **SET**(C) to exit the Set mode.

**NOTE:**

- Use GPS automatic transmission in only the simplex mode.
- GPS automatic transmission through a repeater may interfere with other communications. When a GPS message is programmed, the transceiver transmits it along with the position data. See page 10-17 for the GPS message programming.

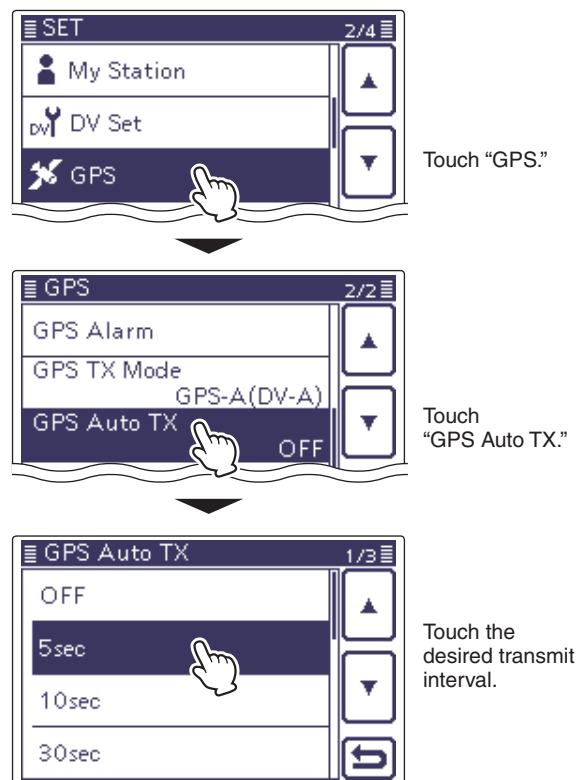
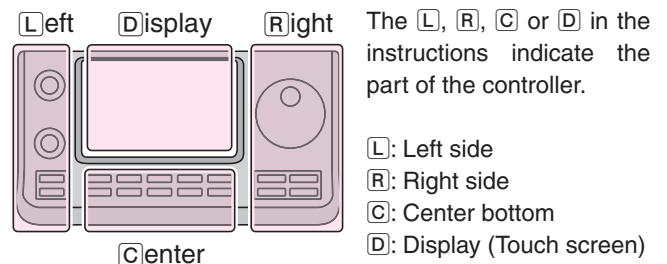

# Section 11 MEMORY OPERATION

---

<b>General description.....</b>	<b>11-2</b>
◇ Memory channel contents .....	11-2
<b>Selecting a Memory channel .....</b>	<b>11-3</b>
◇ Selecting in the VFO mode .....	11-3
◇ Selecting in the Memory mode.....	11-3
<b>Selecting a Call channel .....</b>	<b>11-4</b>
<b>Programming a Memory channel .....</b>	<b>11-5</b>
◇ Programming in the VFO mode.....	11-5
◇ Programming in the Memory mode.....	11-5
◇ Programming the Call channels .....	11-5
◇ Programming in the DR mode.....	11-6
◇ Checking the programmed Memory contents .....	11-7
◇ Checking the Memory contents programmed in the DR mode .....	11-7
<b>Clearing a Memory channel.....</b>	<b>11-8</b>
<b>Copying Memory contents .....</b>	<b>11-9</b>
◇ Copying in the Memory mode .....	11-9
◇ Copying in the VFO mode .....	11-9
<b>Programming a Memory name .....</b>	<b>11-10</b>
<b>Selecting a Memory display type .....</b>	<b>11-12</b>
<b>Memo pad function.....</b>	<b>11-13</b>
◇ Writing the displayed contents into the Memo pads.....	11-13
◇ Calling up the Memo pads.....	11-14

## General description

The transceiver has a total of 495 Memory channels (99 channels in each of 5 memory banks, A to E), 6 Scan Edge channels (3 pairs) and two Call channels (C1/C2) each for the 144 and 430 MHz frequency bands. The Memory mode is useful to quickly select often-used frequencies.

While in the memory mode, all 505 Memory channels are tunable, which means the programmed frequency can be temporarily tuned with the Dial.

When you tune a Memory channel without storing, and then go back to the channel again, the original stored frequency is displayed.

In the Memory mode, touch just above MHz area on the display, and then select the desired band. Then rotate the Dial to select the frequency to be stored.

Memory Channels	Descriptions
1–99 (Total of 495)	Regular Memory channels with split frequency capability.
1A/1B–3A/3B	Program Scan Edge Memory channels with only simplex capability. Stores the Scan Edge frequencies for programmed scans.
C1/C2	Two Call channels (C1/C2) each for the 144 and 430 MHz frequency bands. Call channel with split frequency capability. Instantly recalls a specified frequency.

### ◇ Memory channel contents

The following information can be programmed into Memory channels:

- Operating frequency (p. 3-7)
- Operating mode (p. 3-17)
- IF filter number (p. 5-6)
- Split data (p. 6-8)  
(Usable only on the regular Memory channels and Call channels.)
- Memory name (p. 11-10)
- Duplex direction (DUP+ or DUP–) and frequency offset (p. 4-25)
- Subaudible tone encoder (p. 4-26), tone squelch or DTCS squelch ON/OFF (pp. 4-22, 4-23)
- Subaudible tone frequency (p. 4-26), tone squelch frequency or DTCS code with polarity (pp. 4-22, 4-23)
- Destination call sign (p. 9-45)
- R1/R2 call signs (p. 9-26)
- Call sign squelch or Digital code squelch ON/OFF (p. 9-22)
- Digital code (p. 9-22)

#### NOTE:

Memory content can be erased by static electricity, electric transients, and other causes. In addition, they can be erased by a malfunction or during repairs. Therefore, we recommend that you backup the memory content or save it to an SD card or to a PC.

- The SD card is not available from Icom. Purchase an SD card to meet your needs.
- The optional CS-7100 CLONING SOFTWARE can also be used to backup your memory data.

## Selecting a Memory channel

### ◇ Selecting in the VFO mode

- ① Touch the Memory channel number indication once or twice to select the VFO mode. (p. 3-4)
  - ② Rotate [BANK](L) to select a Memory bank that contains the channel you want to select.
  - ③ Rotate [M-CH](L) to select a Memory channel number.
    - Rotate clockwise to select a higher Memory channel number; rotate counterclockwise to select a lower Memory channel number.
    - All Memory channels, including blank channels, can be selected.
    - “BLANK” appears when no information has been programmed into the Memory channel. (Blank channel)
    - You can do either step ② or ③ first.
- NOTE:** When the **PBT** indicator lights green, or the RIT indicator lights orange, push [M-CH](L) to turn OFF the indicator first, and then rotate it.
- ④ Touch the Memory channel number indication to select the Memory mode.
    - “MEMO” and the Memory channel contents appear.

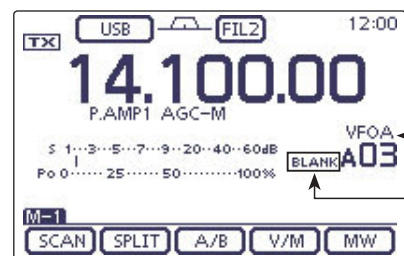
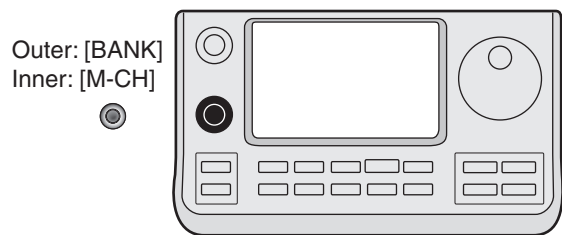
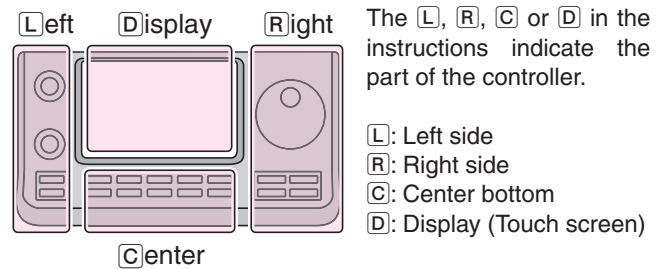

While in the VFO mode

### ◇ Selecting in the Memory mode

- ① Touch the Memory channel number indication once or twice to select the Memory mode. (p. 3-4)
- ② Rotate [BANK](L) to select a Memory bank that contains the channel you want to select.
- ③ Rotate [M-CH](L) to select a Memory channel number.
  - Rotate clockwise to select a higher Memory channel number; rotate counterclockwise to select a lower Memory channel number.
  - All Memory channels, including blank channels, can be selected.
  - “BLANK” appears when no content has been programmed into the Memory channel. (Blank channel)
  - Memory channels can also be selected using the microphone [UP]/[DN] keys. In such case, the blank channels are skipped.

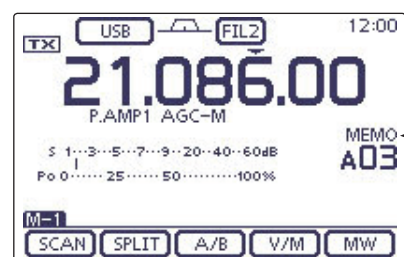

While in the Memory mode



## Selecting a Call channel

Two Call channels (C1/C2) are selectable in each of the 144 and 430 MHz frequency bands.

Factory default frequencies and operating modes are programmed into the Call channels. Change these to suit your operating needs.

- ① Select the 144 or 430 MHz frequency band. (p. 3-6)
- ② Push **TUNER/CALL**(L) to select the Call channel of the selected frequency band.
  - “CALL1” appears.
  - Rotate [M-CH] to select “CALL2.”
- ③ Push **TUNER/CALL**(L) again to return to the previous screen display.

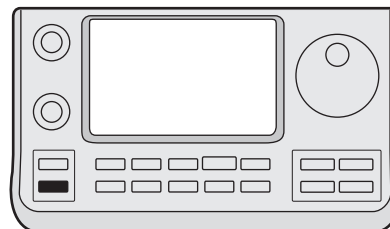

TUNER/CALL



← Appears

While in the Call channel mode

## Programming a Memory channel

Memory channels can be programmed in either the VFO mode or the Memory mode.

**NOTE:** If you perform the operations as described below in a pre-programmed channel, the previous channel content will be overwritten.

### Programming in the VFO mode

- ① Touch the Memory channel number indication once or twice to select the VFO mode. (p. 3-4)
- ② Set the desired contents into VFO A or VFO B.
- ③ Rotate [BANK](L) or [M-CH](L) to select the Memory channel to be programmed.
  - “BLANK” appears when no content has been programmed into the Memory channel. (Blank channel)
- ④ Touch [MW](D) for 1 second to program the contents into the Memory channel.

### Programming in the Memory mode

- ① Touch the Memory channel number indication once or twice to select the Memory mode. (p. 3-4)
- ② Rotate [M-CH](L) to select the Memory channel to be programmed.
  - The contents of the Memory channel appear in the display.
  - “BLANK” appears if the selected Memory channel is a blank channel.
- ③ Set the desired contents into the Memory channel.
  - When a blank channel is selected, touch just above MHz area on the display, and then select the desired **band**. Rotate the Dial to select the frequency. (p. 3-4)
- ④ Touch [MW](D) for 1 second to program the contents into the Memory channel.

### Programming the Call channels

It is convenient to program often-used frequencies into the Call channels for quick recall.

- ① Rotate [M-CH](L) to select a Call channel.
  - A capital “C” appears.
- ② Set the desired contents into the channel.
- ③ Touch [MW](D) for 1 second to program the contents into the Call channel.

#### IMPORTANT!

When a Call channel is selected by pushing **TUNER/CALL** (L), you cannot change the memory contents. However, when a Call channel is selected using [M-CH] in the VFO or Memory mode, the memory contents can be changed.

The 144 MHz frequency band can be programmed into the 144 “C1” or C2,” and the 430 MHz frequency band can be programmed into the 430 “C1” or C2.”

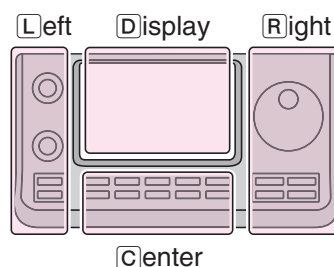

The L, R, C or D in the instructions indicate the part of the controller.

- L: Left side
- R: Right side
- C: Center bottom
- D: Display (Touch screen)

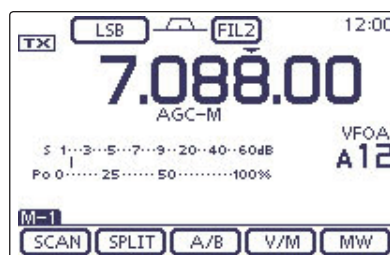

**[Example]:** Programming 7.088 MHz/LSB into Memory channel 12 while in the VFO mode.

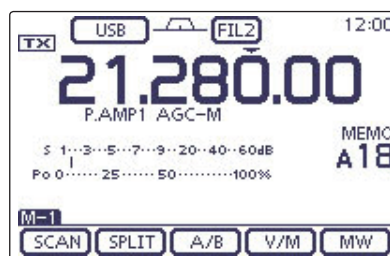

**[Example]:** Programming 21.280 MHz/USB into Memory channel 18 while in the Memory mode.

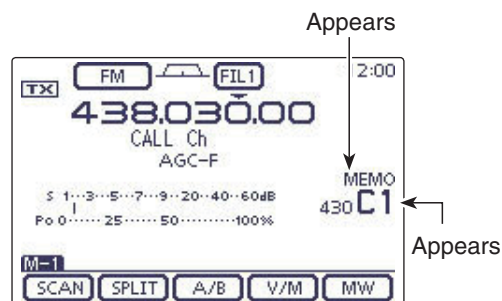

While in the Memory mode

## Programming a Memory channel (Continued)

### ◇ Programming in the DR mode

- ① Push **[DR]** to select the DR mode. (Section 8)
- ② Set the desired contents. (Section 8)
- ③ Push **[MENU]**(**C**) one or more times to select the “D-2” screen.
- ④ Touch **[MW]**(**D**).
  - The “MW” screen appears.
- ⑤ Rotate **[BANK]**(**L**) or **[M-CH]**(**L**) to select the Memory channel to be programmed.
  - “-----” appears when no content has been programmed into the Memory channel. (Blank channel)
- ⑥ Touch **[MW]**(**D**) for 1 second to program the contents into the Memory channel.
- ⑦ Check the programmed contents on the Memory mode. (p. 11-3)

#### ✓ For your reference

The Memory channel contents, programmed in the DR mode, can also be copied to the VFO. (p. 11-9)

The **[L]**, **[R]**, **[C]** or **[D]** in the instructions indicate the part of the controller.

**[L]**: Left side, **[R]**: Right side, **[C]**: Center bottom  
**[D]**: Display (Touch screen)

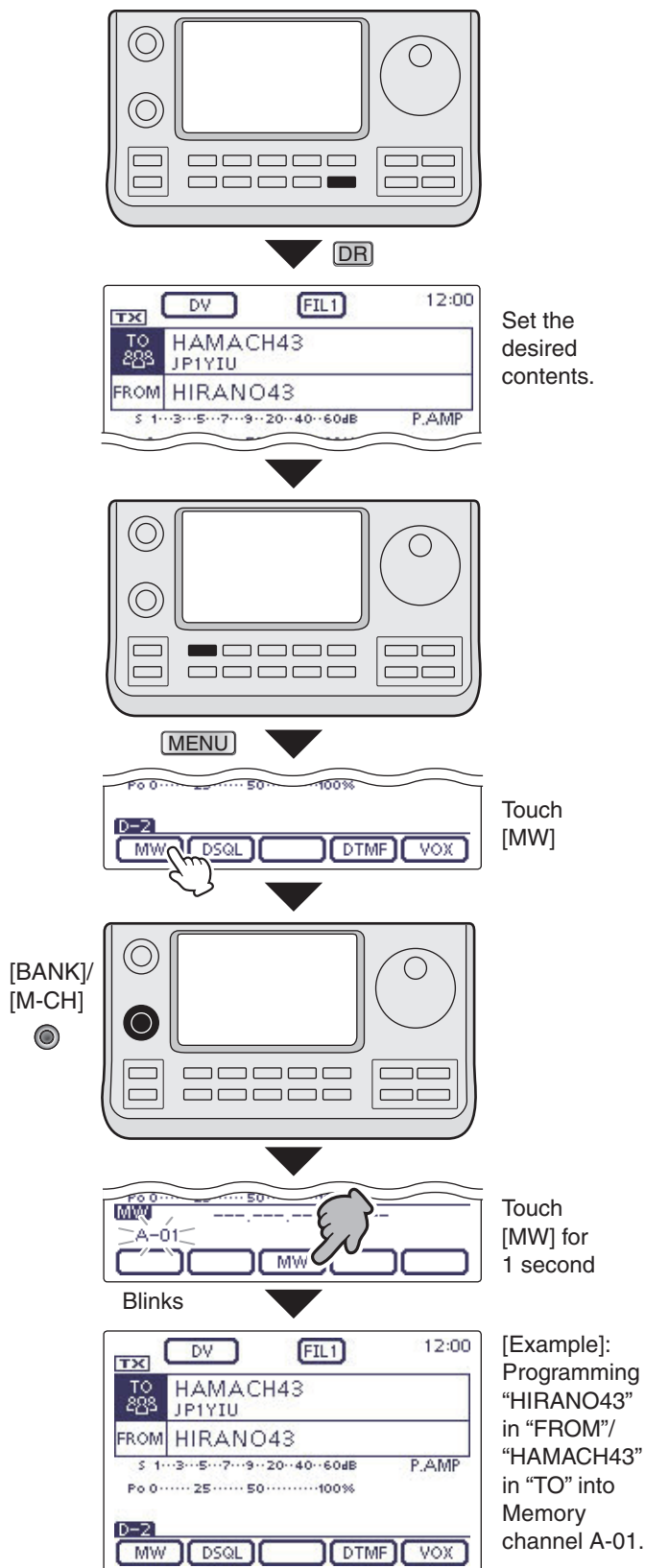

## Programming a Memory channel (Continued)

### ◇ Checking the programmed Memory contents

The programmed Memory channels can be checked on the "MEMORY LIST" screen.

- ① When the "M-3" (Menu 3) screen is selected, touch [MEMO](D) to display the "MEMO" (Memory) screen.
- ② Rotate [BANK](L) to select the Memory bank (A to E) to be checked.
- ③ Touch [LIST](D) to display the "MEMORY LIST" screen.
  - Touch [▲] or [▼](D) to select the displayed page.
  - The Program Scan Edge Memory channels can be checked on any band screen.

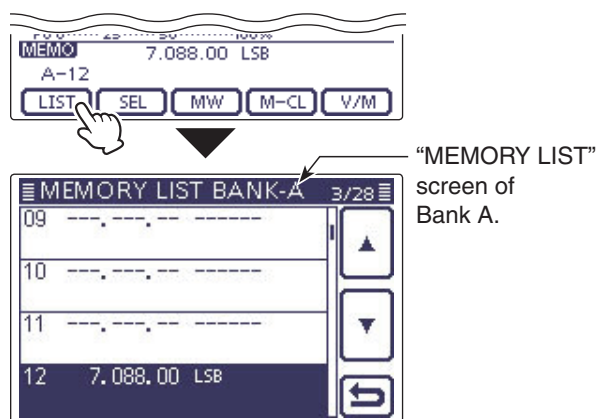
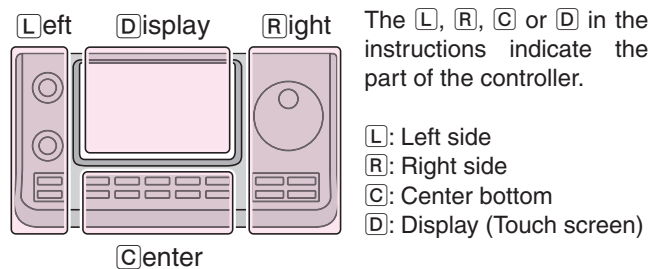

### ◇ Checking the Memory contents programmed in the DR mode

- ① Push [DR] one or more times to cancel the DR mode.
- ② Touch the Memory channel number indication once or twice to select the Memory mode. (p. 3-4)
  - The access repeater call sign and the destination call sign appear.

When the "M-2" (Menu 2) screen is selected, touch [CS](D) to display the call sign programmed in the selected channel.

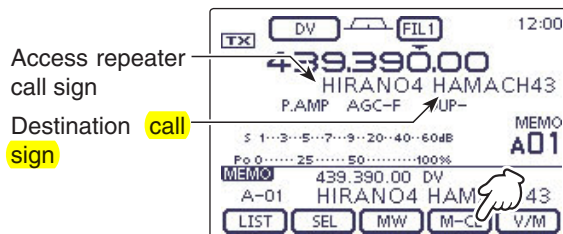

### ✓ For your reference

"FROM" and "TO" names are automatically programmed as the Memory name.

- The Memory name is not overwritten when the memory contents are programmed into the preprogrammed channel.

## Clearing a Memory channel

Any no longer used regular Memory channels can be cleared, and then become blank channels.

- ① Touch the Memory channel number indication once or twice to select the Memory mode. (p. 3-4)
- ② Rotate [BANK](L) or [M-CH](L) to select the Memory channel to be cleared.
- ③ Push [MENU](C) one or more times to select the “M-3” screen (Menu 3).
- ④ Touch [MEMO](D).
- ⑤ Touch [M-CL](D) for 1 second to clear the contents.
  - The programmed contents disappear.
  - “BLANK” appears.

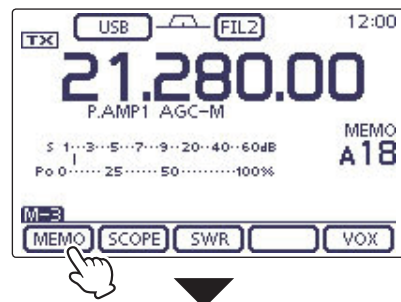
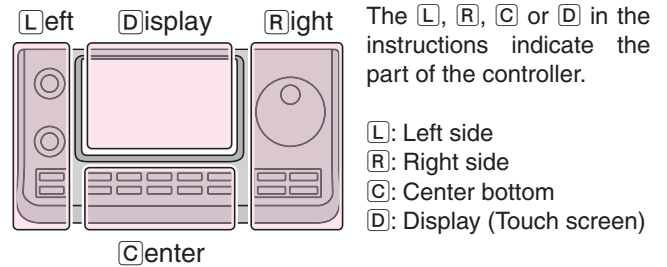

Touch [MEMO].

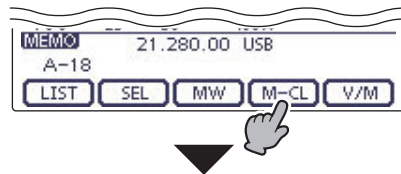

Touch [M-CL] for 1 second.

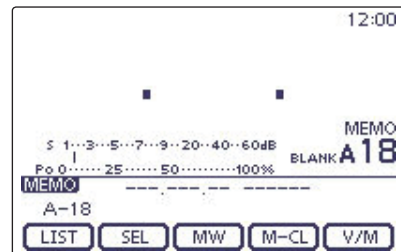

## Copying Memory contents

The Memory channel contents (frequency, operating mode, and so on.) can be copied to the VFO.

### ◇ Copying in the Memory mode

- ① Touch the Memory channel number indication once or twice to select the Memory mode. (p. 3-4)
- ② Rotate [BANK](L) or [M-CH](L) to select the Memory channel to be copied.
  - “BLANK” appears if the selected Memory channel is a blank channel. In this case nothing can be copied.
- ③ Touch [V/M](D) for 1 second to copy the Memory channel contents into the VFO.
- ④ Touch the Memory channel number indication to select the VFO mode. (p. 3-4)

### ◇ Copying in the VFO mode

- In the VFO mode, select the Memory channel number to be copied. And then, touch [V/M] for 1 second to copy the Memory channel contents into the selected VFO.
  - “BLANK” appears if the selected Memory channel is a blank channel. In this case nothing can be copied.

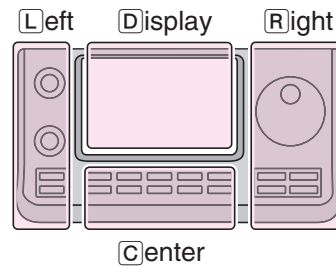

The [L], [R], [C] or [D] in the instructions indicate the part of the controller.

- [L]: Left side
- [R]: Right side
- [C]: Center bottom
- [D]: Display (Touch screen)

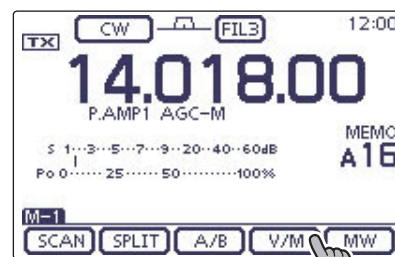

Touch [V/M] for 1 second.

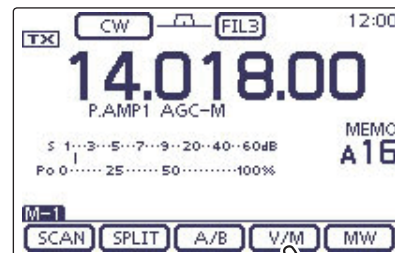

The Memory channel contents are transferred into the selected VFO. (The display does not change.)

Touch [V/M].



## Programming a Memory name

All Memory channels, including Scan Edges and Call channels, can be tagged with alphanumeric names of up to 16 characters each.

**[EXAMPLE]:** Programming a memory name into Memory channel 99 of Bank A.

- ① Touch the Memory channel number indication once or twice to select the Memory mode. (p. 3-4)
- ② Rotate [BANK] to select Bank A.
- ③ Rotate [M-CH] to select the Memory channel 99.
- ④ Push **MENU**(C) one or more times to select the “M-3” screen (Menu 3).
- ⑤ Touch [MEMO](D) to display the “MEMO” screen (Memory Menu).
- ⑥ Touch [LIST](D) to display the “MEMORY LIST” screen.
- ⑦ Push **QUICK**(C), and then touch [Edit Name] to enter the “MEMORY NAME” screen (Memory name edit screen).
  - A cursor appears and blinks.
  - If the channel you selected is a blank channel, [Edit Name] does not appear.
- ⑧ Touch the desired block one or more times to select the desired character or symbol.

Selectable characters and symbols
A to Z, a to z, 0 to 9, ! # \$ % & \ ? " ' ` ^
+ - * / . , : ; = < > ( ) [ ] { }   _ ` @ (space)

- Touch “AB↔12” to toggle between the Alphabet input and Number input mode.
- Touch [CLR](D) to delete the selected character, symbol or number.
- Touch [ [AB] ](D) to open the input mode selection window.
- Touch “\_” to input a space.

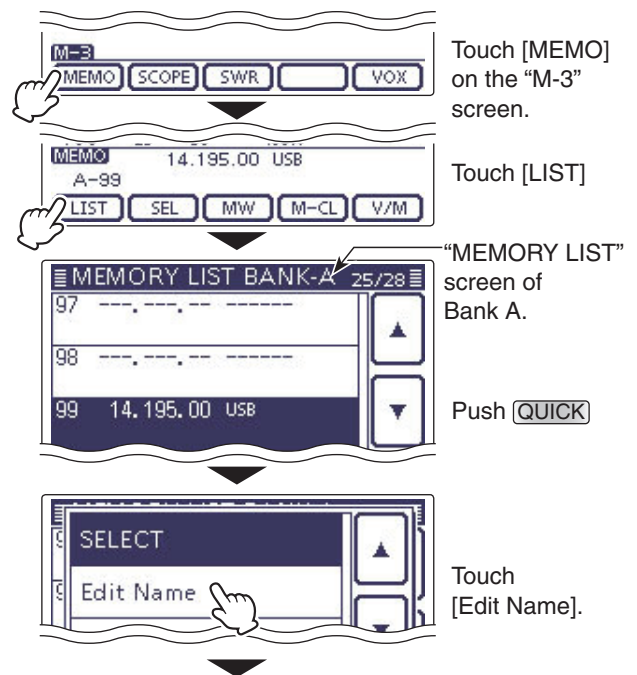
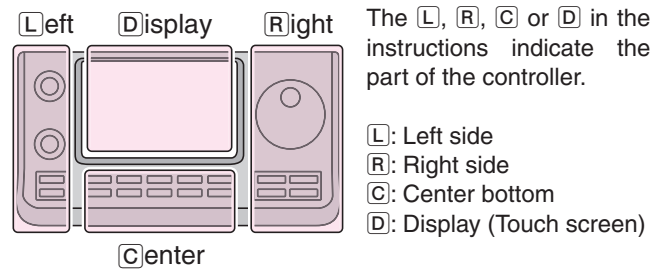

### Memory name edit screen

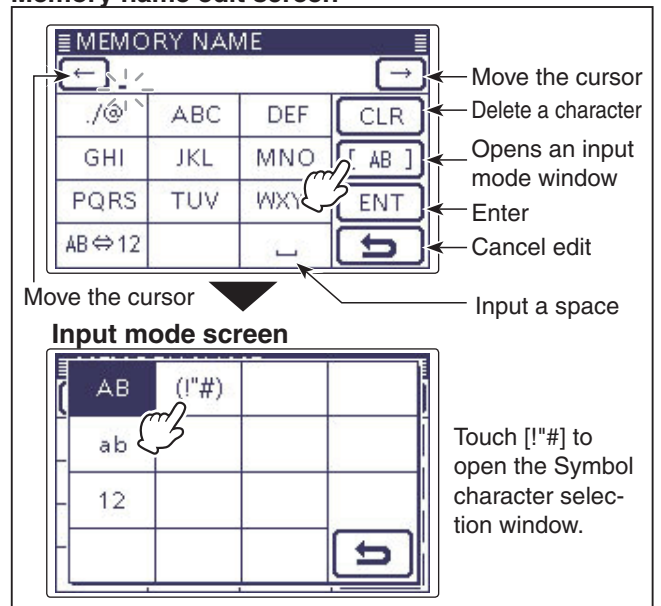

Continued on the next page.



## Programming a Memory name (Continued)

- ⑨ Touch [←](D) to move the cursor backwards, or touch [→](D) to move the cursor forwards.
- ⑩ Repeat steps ⑧ and ⑨ to program up to 16 characters memory name, and then touch [ENT](D) to save the name, and return to the “MEMORY LIST” screen.
- ⑪ Touch [↵](D) to return to the “MEMO” (Memory) screen.
  - Push [MENU](C) to return to the “M-3” screen (Menu 3).

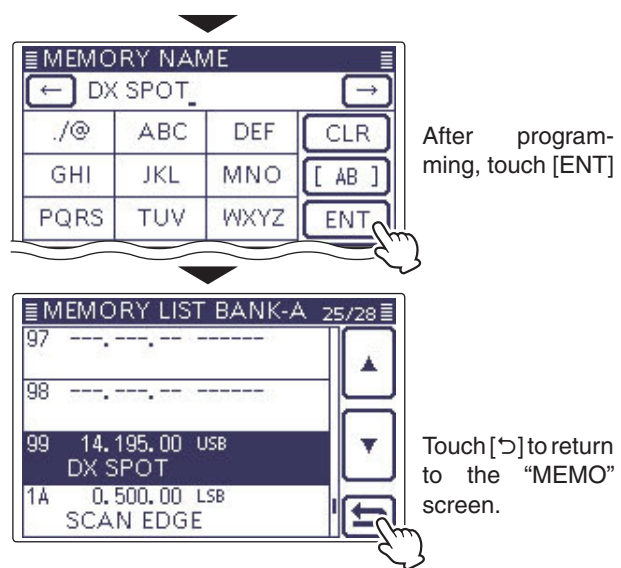

## Selecting a Memory display type

While in the memory mode, the programmed memory name can be displayed.

- ① Touch the Memory channel number indication once or twice to select the Memory mode. (p. 3-4)
- ② Push **QUICK**(D) to open the Quick Menu window.
- ③ Touch [Name Display].
- ④ Touch the desired Display type option.
  - OFF: Displays only the frequency.
  - ON: Displays the memory name under the frequency. (Default)

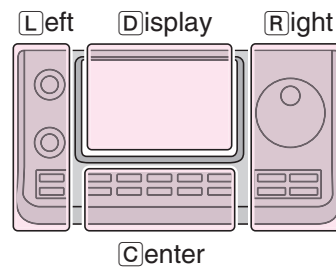

The **L**, **R**, **C** or **D** in the instructions indicate the part of the controller.

- L**: Left side
- R**: Right side
- C**: Center bottom
- D**: Display (Touch screen)

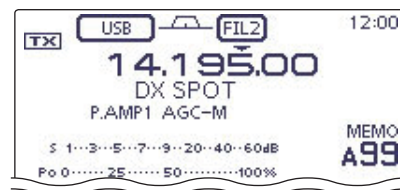

Push **QUICK**.



Touch [Name Display].

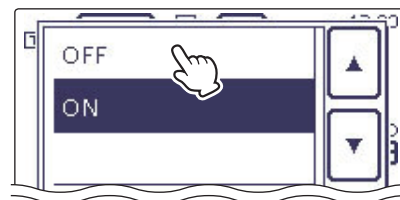

Touch "OFF."

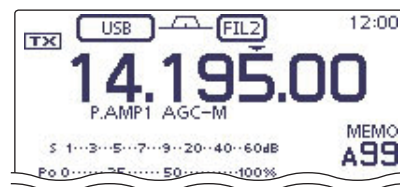

The memory name disappears.

## Memo pad function

The transceiver has a Memo pad function to store the displayed content for easy writing and recalling. The Memo pads are separate from the Memory channels. The default number of Memo pads is 5. However, you can increase the number to 10 in the “Memopad Numbers” item of the Function Set mode, if desired. (p. 17-20)

Memo pads are convenient when you want to memorize the displayed content temporarily, such as when you find a DX station in a pile-up, or when a desired station is busy for a long time and you want to temporarily search for other stations.

Use the transceiver’s Memo pads instead of relying on hastily scribbled notes that are easily misplaced.

### ◇ Writing the displayed contents into the Memo pads

You can store the displayed content by pushing **[MPAD]** (**[R]**) for 1 second.

When you store content of the 6th Memo pad, the oldest stored content is automatically erased, to make room for the new content.

**NOTE:** Each Memo pad must have its own unique content; Memo pads having identical content cannot be written.

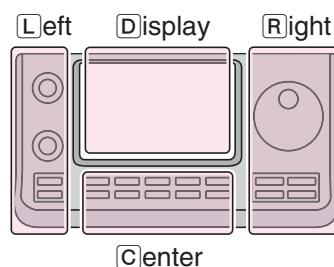

The **[L]**, **[R]**, **[C]** or **[D]** in the instructions indicate the part of the controller.

- [L]**: Left side
- [R]**: Right side
- [C]**: Center bottom
- [D]**: Display (Touch screen)

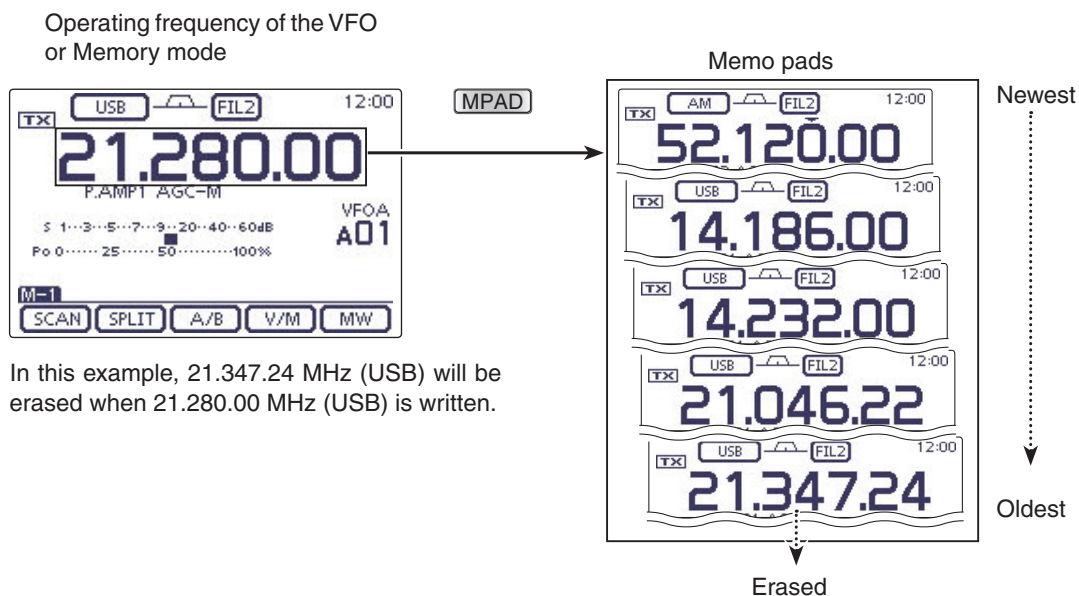

In this example, 21.347.24 MHz (USB) will be erased when 21.280.00 MHz (USB) is written.

## Memo pad function (Continued)

### ◇ Calling up the Memo pads

You can call up a Memo pad by pushing **[MPAD]**(R) one or more times while in either the VFO or Memory mode.

- The Memo pad content is called up, starting from the most recently written.

When you call up a Memo pad, the previously displayed content is automatically stored in a temporary pad. The temporary pad can be recalled by pushing **[MPAD]**(R) one or more times.

- You may think there are 6 Memo pads because 6 different frequencies (5 are in Memo pads and 1 is in the temporary pad) are called up by **[MPAD]**(R).

/// If you change the contents called up from a Memo pad, the stored temporary pad content is replaced with the changed content.

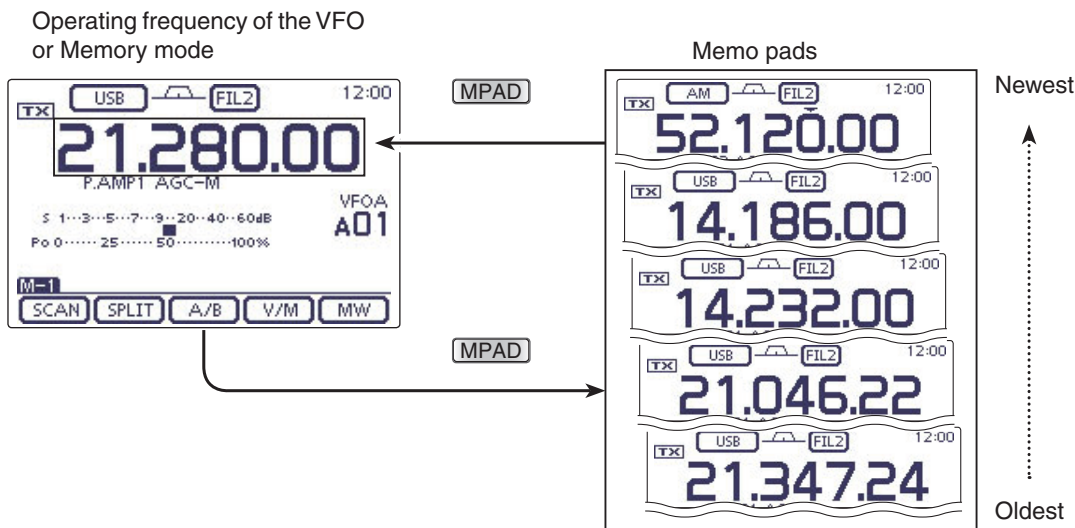

# Section 12 SCAN OPERATION

---

Scan types.....	12-2
Preparation.....	12-3
Scan Set mode.....	12-4
Voice Squelch Control function .....	12-6
Scan edge programming .....	12-7
Programmed scan (VFO mode).....	12-8
Fine programmed scan (VFO mode).....	12-9
Memory scan (Memory mode).....	12-10
◇ Memory scan.....	12-10
◇ Mode Select scan.....	12-11
◇ Select Memory scan.....	12-12
◇ Setting/Cancelling Select Memory channels.....	12-13
$\Delta F$ scan and Fine $\Delta F$ scan (VFO mode/Memory mode).....	12-14
◇ About the $\Delta F$ scan .....	12-14
◇ About the Fine $\Delta F$ scan .....	12-15
VFO frequency and a priority channel.....	12-16
DR mode and a priority channel .....	12-17

## Scan types

Scanning automatically searches for signals and makes it easier to locate new stations for contact or listening purposes. The IC-7100 has several **scan** types; Programmed scan, Memory scan, Select Memory scan, Mode Select scan and  $\Delta F$  (Delta Frequency) scan.

Rotating the Dial changes the scanning direction as the default. The Dial functions during a scan can be set in the Scan Set mode. (p. 12-5)

### PROGRAMMED SCAN (p. 12-8)

Repeatedly scans between scan edges. P1 scans between 1A and 1B, P2 scans between 2A and 2B, and P3 scans between 3A and 3B frequencies. This scan operates in the VFO mode.

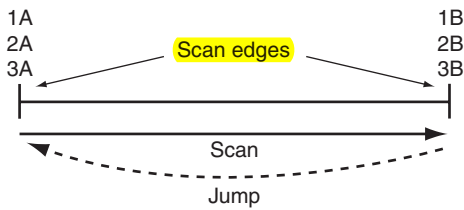

### MEMORY SCAN (p. 12-10)

Repeatedly scans all programmed Memory channels. This scan operates in the Memory mode.

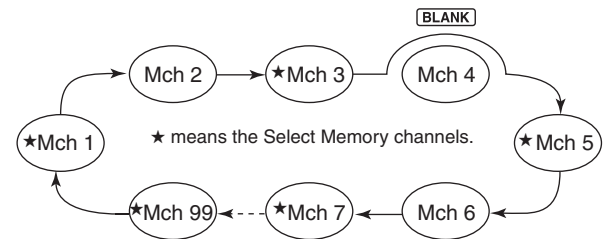

### MODE SELECT SCAN (p. 12-11)

Repeatedly scans all selected Memory mode channels. This scan operates in the Memory mode.

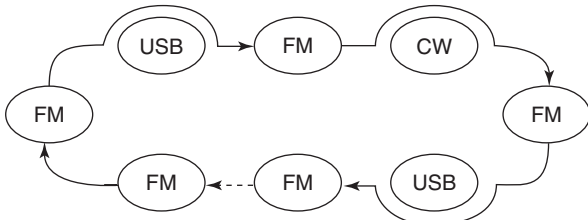

### SELECT MEMORY SCAN (p. 12-12)

Repeatedly scans all Select Memory channels. This scan operates in the Memory mode.

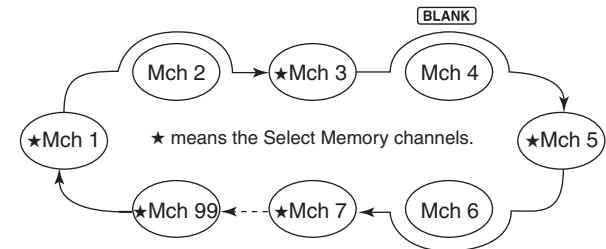

### $\Delta F$ SCAN (p. 12-14)

Repeatedly scans within the  $\Delta F$  span area. This scan operates in both VFO and Memory modes.

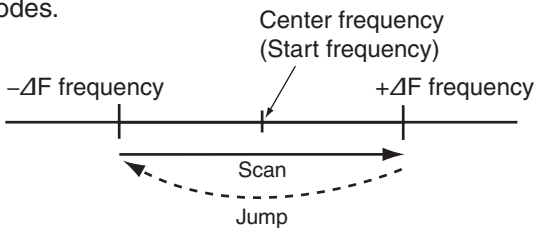

### PRIORITY SCAN (p. 12-16)

Checks the selected priority channel every 5 seconds:

- While receiving on a VFO frequency
- During a VFO mode scan for the VFO mode
- While receiving on a repeater in the DR mode
- During a DR mode scan for the DR mode

This scan operates in the VFO or DR mode.

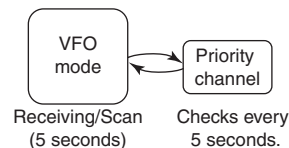

A Memory channel, Call channel or Program Scan Edge channel can be selected as the priority channel.

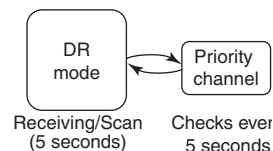

A VFO frequency, Memory channel, Call channel or Program Scan Edge channel can be selected as the priority channel.

## Preparation

### For a Programmed scan:

Program scan edge frequencies into Program Scan Edge channels “1A–3A” and “1B–3B.” (p. 12-7)

### For a Memory scan:

Program two or more Memory channels. (Program Scan Edge channels will not be scanned.) (p. 11-5)

### For a Mode Select scan:

Program two or more Memory channels, all with the same operating mode. (p. 11-5)

### For a Select Memory scan:

Program two or more Memory channels as Select Memory channels. (p. 11-5)

### For a $\Delta F$ scan:

Set the  $\Delta F$  span ( $\Delta F$  scan range) in the “SCAN” screen. (p. 12-14)

### • Scan Resume function

You can set the scan to resume or cancel when detecting a signal in the Scan Set mode. The Scan Resume function must be set before starting a scan. (p. 12-5)

### • Scan speed

The scan speed can be set to fast or slow in the Scan Set mode. (p. 12-5)

### • Dial function

How the Dial functions during a scan, can be set in the Scan Set mode. (p. 12-5)

### • Squelch status

#### ○ The scan starts with the squelch open

##### For a programmed scan:

When the tuning step is 1 kHz or less:

The scan continues until it is manually stopped— it does not pause\*, even if signals are detected.

\* The scan is paused when the squelch is closed and then opened. The scan resumes, or is cancelled, depending on the Scan Resume setting.

When the tuning step is 5 kHz or more:

If Scan Resume is ON, the scan pauses on each step when a signal is detected, then resumes.

If the Scan Resume is OFF, the scan does not start.

##### For memory scan:

If Scan Resume is ON, the scan pauses on each channel when a signal is detected, then resumes.

If Scan Resume is OFF, the scan does not start.

#### ○ The scan starts with the squelch closed

The scan pauses when a signal is detected. The scan resumes, or is cancelled, depending on the Scan Resume setting.



## Scan Set mode

The Scan speed, Scan Resume function, Pause Timer, Resume Timer and the Dial function can be set in the Scan Set mode.

- ① Push **MENU**(C) one or more times to select the “M-1” (Menu 1) screen.
- ② Touch **[SCAN]**(D) to display the “SCAN” screen.
- ③ Touch **[SET]**(D) to display the “SCAN SET” screen.
- ④ Touch the desired item.
  - To go back the previous tree level, touch **[↶]**(D), or **MENU**(C).
- ⑤ Touch a desired option shown on the display.
  - When you touch an option, it is automatically saved and goes back the previous tree level.
  - Push **QUICK**(C), and then touch “Default” to reset to the default setting, if desired.
- ⑥ Push **MENU**(C) to return to the “SCAN” screen.

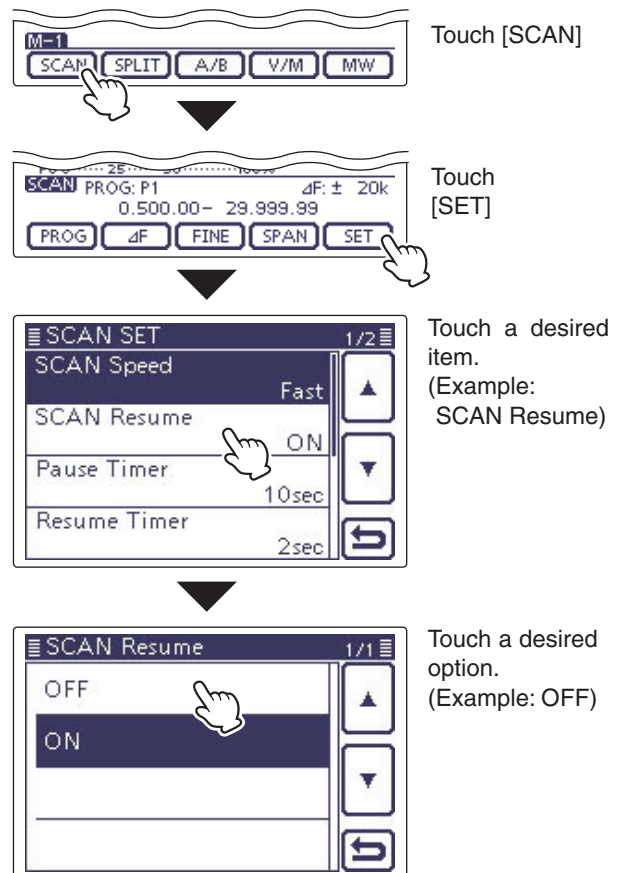
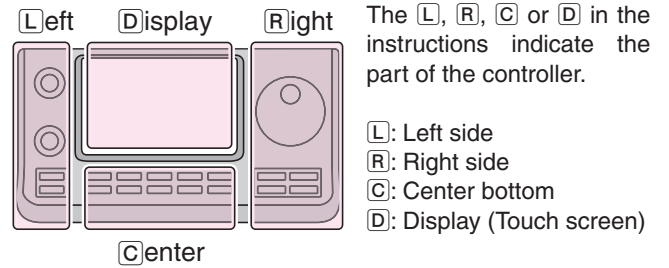

### Scan Set mode (Continued)

#### **SCAN Speed** (Default: Fast)

Select the desired scan speed between slow and fast.

- Slow: The scan is slower.
- Fast: The scan is faster.

#### **SCAN Resume** (Default: ON)

Set the Scan Resume function ON or OFF.

- OFF: When a signal is detected, the scan is cancelled.
- ON: When a signal is received during a scan, the scan pauses for the set period of time in the "Pause Timer" setting, and then resumes. When the signal disappears, the scan resumes after the set period of time in the "Resume Timer" setting.

#### **Pause Timer** (Default: 10 sec)

Select the scan Pause Timer.

When a signal is received, the scan pauses according to this setting.

When the "SCAN Resume" is set to "OFF," this setting is invalid.

- 2 to 20 sec: When a signal disappears while pausing the scan for 2 to 20 seconds (in 2 seconds steps), the scan resumes according to the setting in the Resume Timer.
- Hold: When receiving a signal, the scan pauses and resumes when it disappears, according to the setting in Resume Timer.

#### **Resume Timer** (Default: 2sec)

Select the scan Resume Timer.

When a received signal disappears, the scan resumes according to this setting.

When the "SCAN Resume" is set to "OFF," this setting is invalid.

- 0 sec: The scan resumes immediately after the signal disappears.
- 1 to 5 sec: The scan resumes 1 to 5 seconds after the signal disappears.
- Hold: The scan remains paused according to the Pause Timer, even if the signal disappears.
  - Rotate the Dial to resume the scan.
  - When "Pause Timer" is set to 2 to 20 seconds, the scan resumes, according to the "Pause Timer" setting.

#### **MAIN DIAL (SCAN)** (Default: Up/Down)

Select the function of the Dial while scanning.

- OFF : Rotating the Dial cancels the **scan**.
- Up/Down : Rotating the Dial changes the scanning direction.

## Voice Squelch Control function

**(Mode: SSB/AM/FM)**

This function is useful when you do not want unmodulated signals pausing or cancelling a scan. When the Voice Squelch Control (VSC) function is ON, the receiver checks received signals for voice components.

The scan pauses, or is cancelled, if a received signal includes voice components, and the tone of the voice components changes within 1 second. See "Squelch status" as described on page 12-3.

The scan resumes if the received signal includes no voice components, or the tone of the voice components does not change within 1 second.

- ① Select SSB, AM or FM as the operating mode.
- ② Push **QUICK**(D) to open the Quick Menu window.
- ③ Touch [VSC].
- ④ Touch the desired option.
  - "VSC" appears when the VSC function is ON.
  - When you touch an option, it is automatically saved and goes back the previous tree level.

- The VSC function is usable in the phone modes (SSB, AM and FM).
- The VSC function resumes the scan on unmodulated signals, regardless of whether the Scan Resume function is set to ON or OFF.

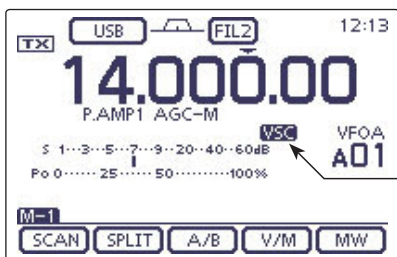

Appears

**NOTE:** While listening to the radio with the VSC function ON, the audio may be interrupted. The music or a commercial, including narration or BGM, is not detected as an audio component. In this case, turn OFF the VSC function.

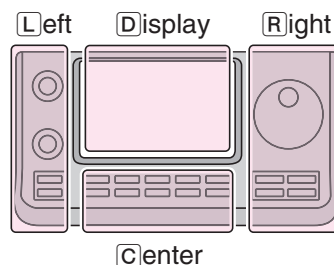

The L, R, C or D in the instructions indicate the part of the controller.

- L: Left side
- R: Right side
- C: Center bottom
- D: Display (Touch screen)

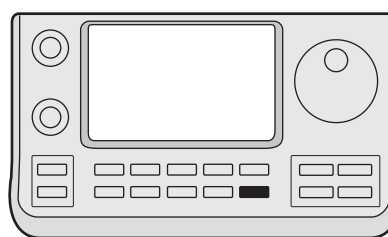

QUICK

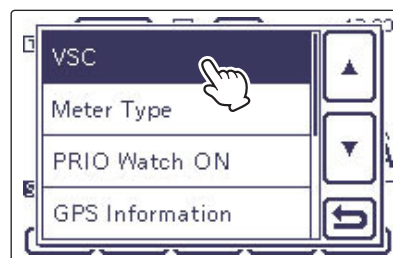

Touch [VSC].



Touch a desired option. (Example: ON)

## Scan edge programming

Memory channels 1A–3A and 1B–3B are the Program Scan Edge channels. They are used to program the upper and lower frequency edges for programmed scans. (See Section 11)

Factory default frequency and operating modes are programmed into the Scan Edge channels: 1A/1B are for HF, 2A/2B are for the 144 MHz, and 3A/3B are for the 430 MHz frequency bands, and you can reprogram it as desired.

▨ If both upper and lower band edges are programmed with the same frequency, a programmed scan cannot start.

**EXAMPLE:** Programming 14.000.00 MHz into 2A and 14.360.00 MHz into 2B.

- ① Touch the Memory channel number indication once or twice to select the VFO mode. (p. 3-4)
- ② Rotate [M-CH] (L) to select scan edge 2A.
- ③ Set 14.000.00 MHz as the lower frequency.
- ④ Push [MENU] (C) one or more times to select the “M-1” (Menu 1) screen.
- ⑤ Touch [MW] (D) for 1 second to program 14.000.00 MHz into scan edge 2A.
  - Three beeps sound when the programming is complete.
- ⑥ Rotate [M-CH] (L) to select scan edge 2B.
- ⑦ Set 14.360.00 MHz as the upper frequency.
- ⑧ Touch [MW] for 1 second to program 14.360.00 MHz into scan edge 2B.
  - Three beeps sound when the programming is complete.

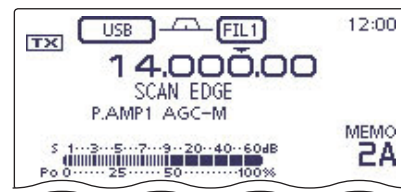
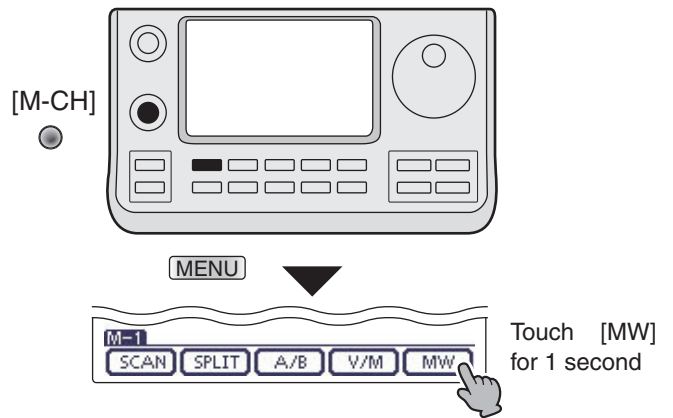
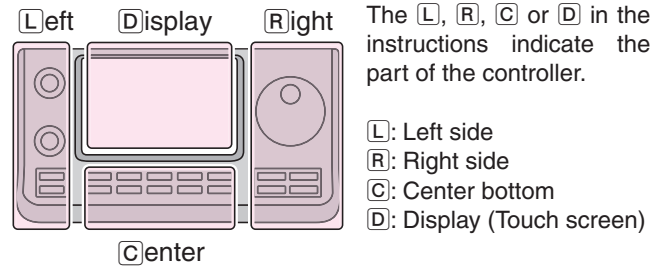

Programming 14.000.00 MHz/USB into 2A.

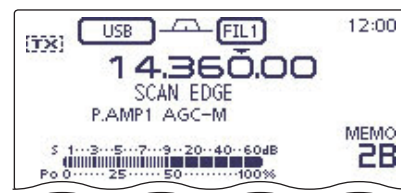

Programming 14.360.00 MHz/USB into 2B.

## Programmed scan (VFO mode)

A programmed scan searches for signals between Program Scan Edge channels “1A–3A” and “1B–3B.” Before starting the programmed scan, scan edges must be programmed into these channels. See the previous page for scan edge programming.

▨ If the same frequencies are programmed into the Program Scan Edge channels, the programmed scan will not start.

- ① Touch the Memory channel number indication once or twice to select the VFO mode. (p. 3-4)
- ② Touch the mode icon to display the Mode selection screen, and then touch the desired operating mode.
  - The operating mode can also be changed while scanning.
- ③ Touch the frequency ‘kHz’ area on the display for 1 second to display the Tuning step selection screen, and then touch the desired tuning step. (p. 3-9)
  - The tuning step can also be changed while scanning.
- ④ Push **MENU**(C) one or more times to select the “M-1” (Menu 1) screen.
- ⑤ Touch **[SCAN]**(D) to display the “SCAN” screen.
- ⑥ Touch **[PROG]**(D) for 1 second, and then touch the desired scan range between “P1,” “P2” and “P3.”
  - The scan searches between programmed scan channels 1A–1B (P1), 2A–2B (P2) or 3A–3B (P3).
  - Example: P2: 14.000.00–14.360.00
- ⑦ Touch **[PROG]**(D) to start the programmed scan.
  - The MHz and kHz decimal points, and the selected scan range display blink while scanning.
  - If “Up/Down” is selected as the “MAIN DIAL (SCAN)” option in the Scan Set mode, rotating the Dial changes the scanning direction. (p. 12-5)
- ⑧ When the scan detects a signal, the scan stops, pauses or ignores it, depending on the Scan Resume function, the VSC function or the squelch status.
- ⑨ Push **[PROG]**(D) to cancel the scan.

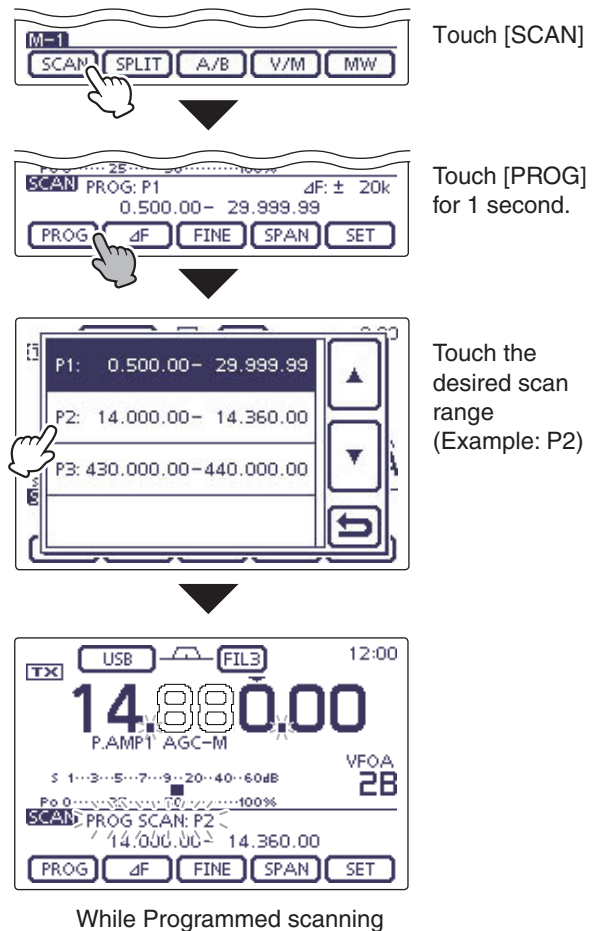
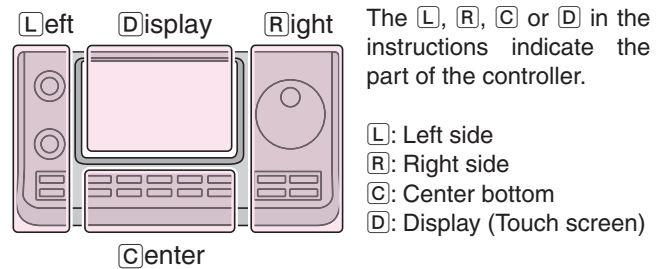

## Fine programmed scan (VFO mode)

When a signal is received during a Fine programmed scan, the scanning tuning step is temporarily set to 10 Hz and the scan speed decreases.

- ① Start the programmed scan.
  - Follow steps ① through ⑦ as described on page 12-8.
- ② While scanning, touch [FINE](D) to switch the scan function between a programmed scan and a Fine programmed scan.
- ③ Touch [PROG](D) to cancel the scan.

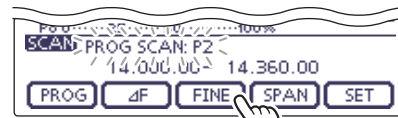
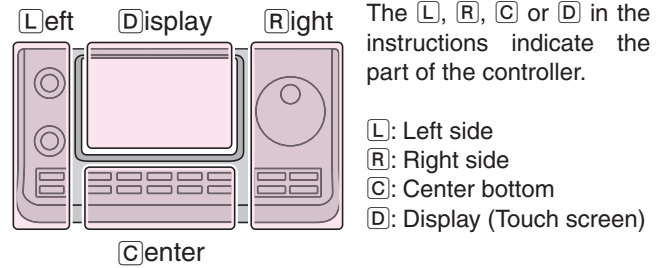

Touch [FINE].

While Programmed scanning

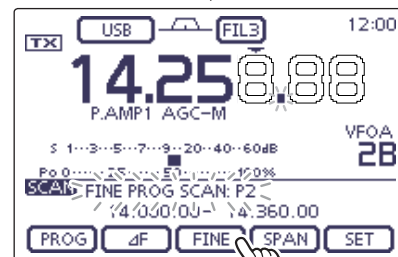

Touch [FINE].

While Fine programmed scanning

## Memory scan (Memory mode)

### ◇ Memory scan

A Memory scan searches for signals through Memory channels 1 to 99.

Blank (unprogrammed) Memory channels are skipped.

/// **NOTE:** For a Memory scan to start, two or more Memory channels must be programmed. (p. 11-5)

- ① Touch the Memory channel number indication once or twice to select the Memory mode. (p. 3-4)
- ② Push **[MENU]**(C) one or more times to select the “M-1” (Menu 1) screen.
- ③ Touch **[SCAN]**(D) to display the “SCAN” screen.
- ④ Touch **[MEMO]**(D) to start the Memory scan.
  - The MHz and kHz decimal points, and “MEMO SCAN” blink while scanning.
  - If “Up/Down” is selected as the “MAIN DIAL (SCAN)” option in the Scan Set mode, rotating the Dial changes the scanning direction. (p. 12-4)
- ⑤ Touch **[MEMO]**(D) to cancel the scan.

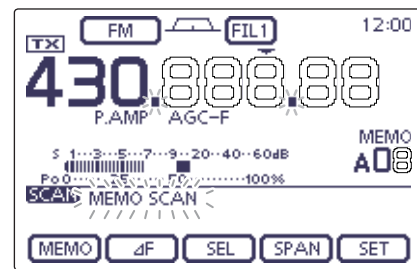
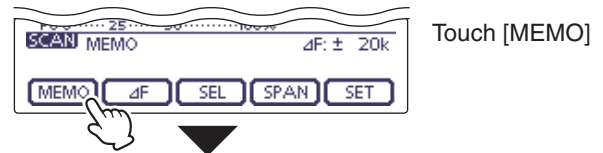
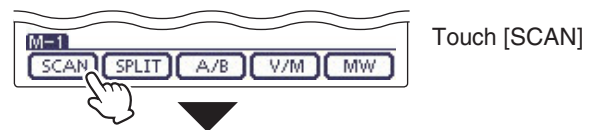
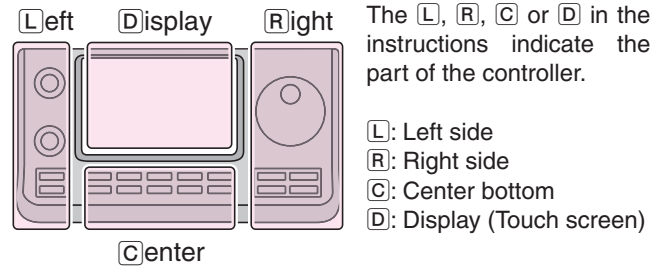



Memory scan (Memory mode) (Continued)

◇ Mode Select scan

Repeatedly scans all Memory channels with the same operating mode as the displayed mode.

**NOTE:** For a Mode Select scan to start, two or more Memory channels must be programmed, and their operating mode must be the same as the displayed mode.

- ① Follow steps ① through ③ as described on page 12-10 to display the "SCAN" screen.
- ② Touch [MEMO](D) for 1 second, and then touch "MODE-SEL" to start the Mode Select scan.
  - The MHz and kHz decimal points, and "MODE-SEL SCAN" blink while scanning.
  - If "Up/Down" is selected as the "MAIN DIAL (SCAN)" option in the Scan Set mode, rotating the Dial changes the scanning direction. (p. 12-4)
- ③ To change the operating mode while scanning, touch the mode icon to display the Mode selection screen, and then touch the desired operating mode.
- ④ Push [MEMO](D) to cancel the scan.

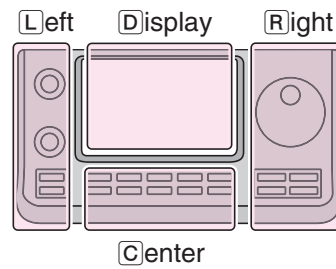

The L, R, C or D in the instructions indicate the part of the controller.

- L: Left side
- R: Right side
- C: Center bottom
- D: Display (Touch screen)

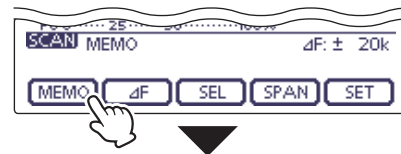

Touch [MEMO] for 1 second



Touch "MODE-SEL."



Touch the mode icon, and then touch the desired operating mode

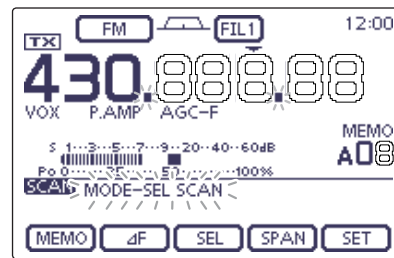

While Mode Select scanning

Memory scan (Memory mode) (Continued)

◇ Select Memory scan

The Select Memory scan searches for signals through Memory channels specified as “★” (Select).

**NOTE:** For a Select Memory scan to start, two or more Memory channels must be designated as Select Memory channels. (See below)

- ① Follow steps ① through ③ as described on page 12-10 to display the “SCAN” screen.
- ② Touch [MEMO](D) for 1 second, and then touch “SEL-MEMO” to start the Select Memory scan.
  - The MHz and kHz decimal points, and “SEL-MEMO SCAN” blink while scanning.
  - If “Up/Down” is selected as the “MAIN DIAL (SCAN)” option in the Scan Set mode, rotating the Dial changes the scanning direction. (p. 12-4)
- ③ Push [MEMO](D) to cancel the scan.

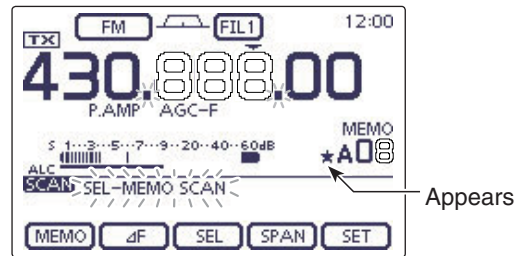
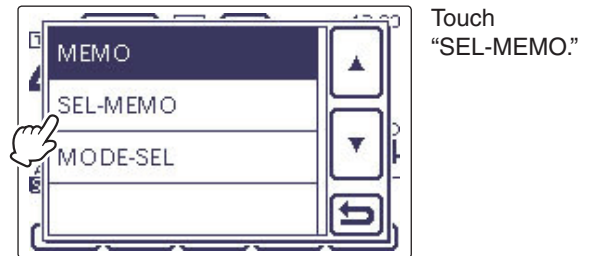
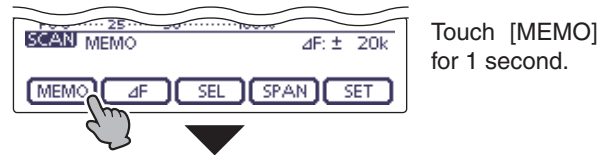
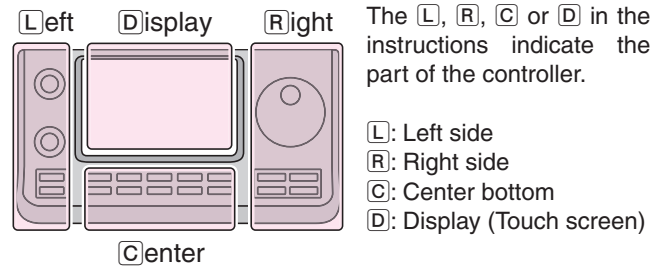

While Select Memory scanning

Memory scan (Memory mode) (Continued)

◇ **Setting/Cancelling Select Memory channels**

All Memory channels can be set as Select Memory channels, except for the Scan Edge and Call channels.

➔ When the “SCAN” screen or the “MEMO” screen (Memory Menu) is displayed, touch [SEL](D) to set or cancel the displayed Memory channel as a Select Memory channel.

- “★” appears when the channel is set as a Select Memory channel.
- An error beep sounds when the displayed Memory channel is a blank channel.
- Touching [SEL](D) for 1 second displays “SELECT ALL Clear?.” Touch [YES](D) to clear all Select Memory channel settings.

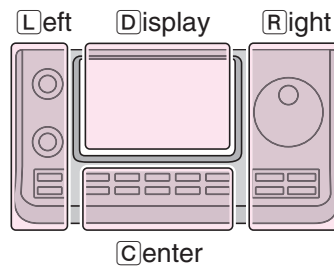

The [L], [R], [C] or [D] in the instructions indicate the part of the controller.

- [L]: Left side
- [R]: Right side
- [C]: Center bottom
- [D]: Display (Touch screen)

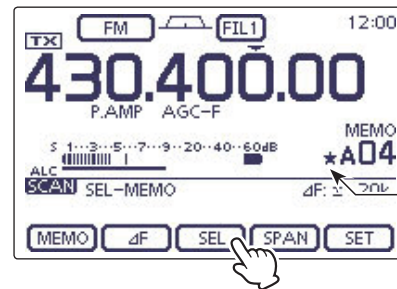

Appears

“SCAN” screen

When the channel is set as a Select Memory channel.



“SELECT ALL Clear?” screen

After touching [SEL] for 1 second to clear all Select Memory channel settings.

## ΔF scan and Fine ΔF scan (VFO mode/Memory mode)

### ◇ About the ΔF scan

ΔF (Delta Frequency) scan searches for signals within the specified range with the displayed VFO frequency or Memory channel frequency as the center frequency. The frequency range is specified by the width of the selected span.

- ① Touch the Memory channel number indication once or twice to select the VFO mode or Memory mode. (p. 12-4)
- ② Push **[MENU]**(C) one or more times to select the “M-1” (Menu 1) screen.
- ③ Touch **[SCAN]**(D) to display the “SCAN” screen.
- ④ Touch **[SPAN]**(D) one or more times to select the desired ΔF span width.
  - ±5 kHz, ±10 kHz, ±20 kHz, ±50 kHz, ±100 kHz, ±500 kHz and ±1 MHz are selectable.
- ⑤ Set the center frequency of the ΔF scan.
  - In the VFO mode, rotate the Dial to set the center frequency.
  - In the memory mode, rotate **[M-CH]** (L) to select the desired Memory channel whose frequency will be the center frequency.
- ⑥ Touch **[ΔF]**(D) to start the ΔF scan.
  - “ΔF SCAN,” the MHz and kHz decimal points blink while scanning.
  - If “Up/Down” is selected as the “MAIN DIAL (SCAN)” option in the Scan Set mode, rotating the Dial changes the scanning direction. (p. 3-4)
- ⑦ When the scan detects a signal, the scan stops, pauses or ignores it, depending on the Scan Resume function, VSC function or the squelch status.
- ⑧ Touch **[ΔF]**(D) again to cancel the ΔF scan.

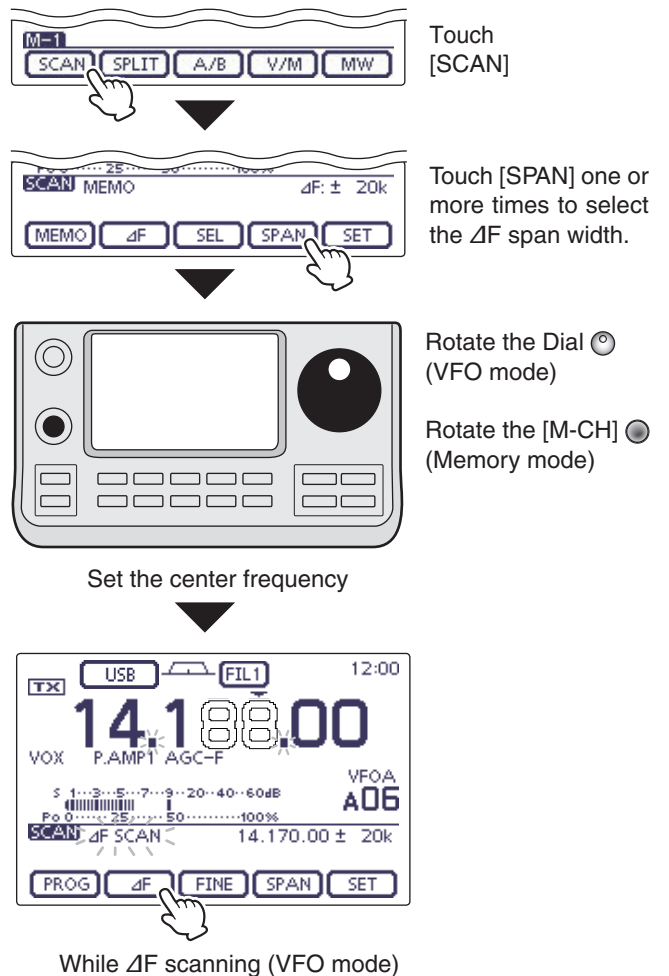
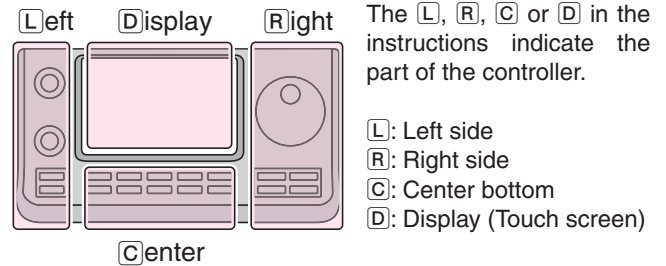

**$\Delta$ F scan and Fine  $\Delta$ F scan (VFO mode/Memory mode) (Continued)**

**◇ About the Fine  $\Delta$ F scan**

When a signal is received during a Fine  $\Delta$ F scan, the scanning tuning step is temporarily set to 10 Hz and the scan speed decreases.

- ① Start  $\Delta$ F scan.
  - Follow steps ① through ⑥ as described on page 12-14.
- ② While scanning, touch [FINE](D) to switch the scan function between  $\Delta$ F scan and Fine  $\Delta$ F scan.
- ③ Touch [ $\Delta$ F](D) to cancel the scan.

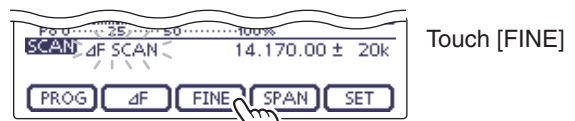
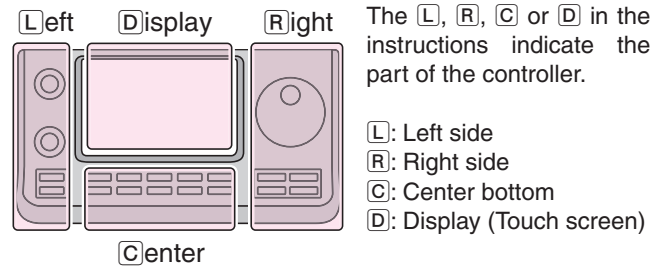

While  $\Delta$ F scanning

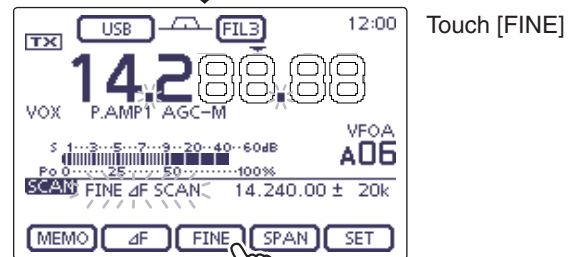

While Fine  $\Delta$ F scanning

## VFO frequency and a priority channel

Checks the selected priority channel every 5 seconds, while receiving on a VFO frequency.

- ① Touch the Memory channel number indication once or twice to select the VFO mode. (p. 3-4)
- ② Set the receive frequency and the operating mode. (p. 3-7, 3-17)
- ③ Touch the Memory channel number indication to select the Memory mode. (p. 3-4)
- ④ Rotate [BANK] or [M-CH] (L) to set the priority channel.
  - Memory channel, Call channel or Program Scan Edge channel can be selected as the priority channel.
- ⑤ Push [QUICK] (D) to open the Quick Menu window.
- ⑥ Touch "PRIO Watch ON" to start the Priority scan.
  - The VFO mode is automatically selected, and **PRIO** appears.
  - To cancel the Priority scan, touch "PRIO Watch OFF" in the Quick Menu window.

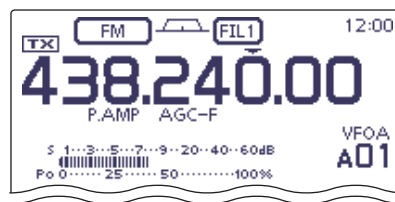
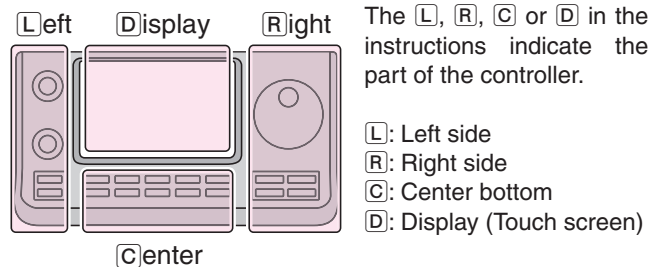

Select the VFO mode

The receive frequency and the operating mode setting

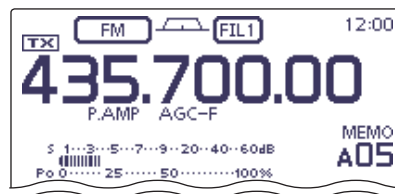

Select the Memory mode

Set the priority channel (Example: A05)

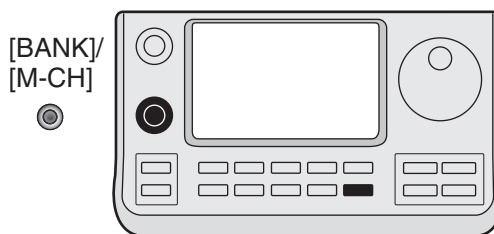

[QUICK]

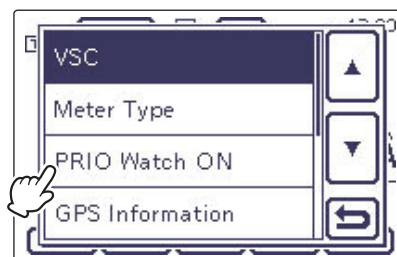

Touch "PRIO Watch ON"

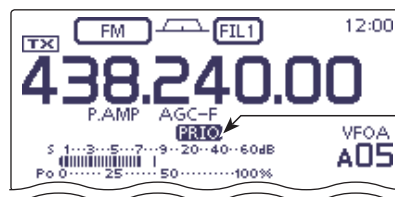

While Priority scanning

**NOTE:**

When the VFO mode is selected, you can normally operate the transceiver; the operating frequency setting, the scanning operation and so on.

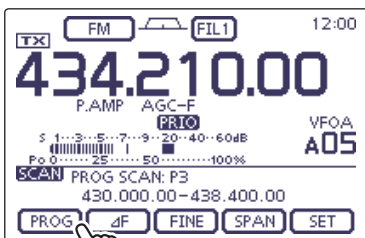

To start the Programmed scan during the Priority scan, touch [SCAN] in the "M-1" (Menu 1) screen, and then touch [PROG].

**When a signal is received on the priority channel**

The Priority channel is automatically selected, and **PRIO** blinks on the screen.

- The scan pause timer and resume settings are the same as for a normal scan.

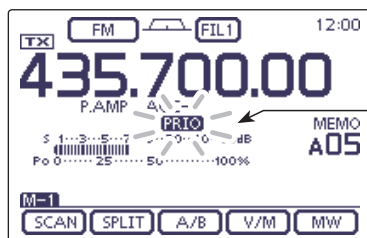

Priority scan automatically pauses.

## DR mode and a priority channel

Checks the selected priority channel every 5 seconds, while receiving a repeater in the DR mode.

### 1. Set the priority channel

**• Using the VFO frequency**

- ① Touch the Memory channel number indication once or twice to select the VFO mode. (p. 3-4)
- ② Set the receive frequency and the operating mode. (p. 3-7, 3-17)

**• Using the Memory/Call/Program Scan Edge channel**

- ① Touch the Memory channel number indication once or twice to select the Memory mode. (p. 3-4)
- ② Rotate [BANK] or [M-CH] (L) to set the priority channel.
  - Memory channel, Call channel or Program Scan Edge channel can be selected as the priority channel.

### 2. Select the repeater in the DR mode

- ① Push [DR] (C) to select the DR mode. (p. 3-17)
- ② Touch "FROM" (Access repeater), if "FROM" is not selected.
- ③ Rotate the Dial to select the desired repeater.
  - You can select a repeater in the "FROM SELECT" screen that is displayed after touching the repeater name on "FROM."

### 3. Start the Priority scan

- ① Push [QUICK] (D) to open the Quick Menu window.
- ② Touch "PRIO Watch ON" to start the Priority scan.
  - The DR mode screen is automatically selected, and [PRIO] appears.
  - To cancel the Priority scan, touch "PRIO Watch OFF" in the Quick Menu window.

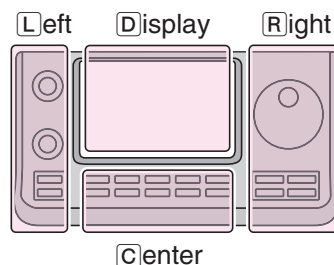

The [L], [R], [C] or [D] in the instructions indicate the part of the controller.

- [L]: Left side
- [R]: Right side
- [C]: Center bottom
- [D]: Display (Touch screen)

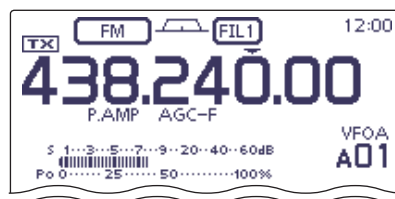

When the VFO frequency is set as the priority channel

The receive frequency and the operating mode setting

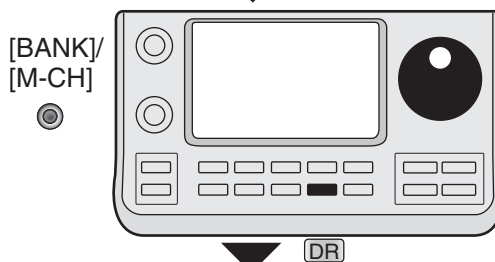

Set the receive frequency in the VFO mode.



Select the DR mode

Select the repeater to receive (Example: Hirano43)



Touch "PRIO Watch ON"



Appears while the priority scanning



## 12 SCAN OPERATION

### DR mode and a priority channel (Continued)

#### NOTE:

When the DR mode screen is displayed, you can normally use the DR mode; “FROM” (Access repeater)/“TO” (Destination) selection, the DR mode scanning and so on.

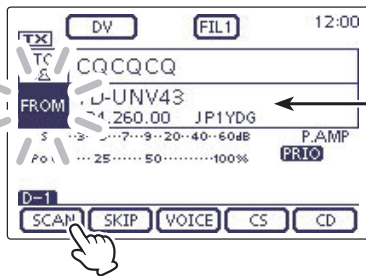

To start the DR mode scan, touch [SCAN] in the “D-1” screen.

#### When a signal is received on the priority channel

The Priority channel is automatically selected, and **PRIO** blinks on the screen.

- The scan pause timer and resume settings are the same as for a normal scan.

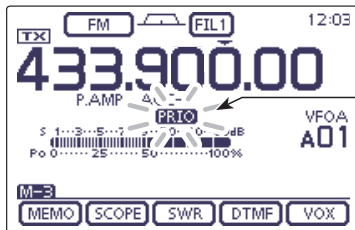

Priority scan automatically pauses.

# Section 13 USING AN SD CARD

---

<b>About the SD card .....</b>	<b>13-2</b>
<b>Saving data onto the SD card.....</b>	<b>13-3</b>
<b>Inserting the SD card .....</b>	<b>13-4</b>
◇ Formatting the SD card .....	13-4
<b>Removing the SD card .....</b>	<b>13-5</b>
◇ Removing the SD card while the transceiver's power is ON .	13-5
<b>Saving the setting data onto an SD card.....</b>	<b>13-6</b>
<b>Saving with a different file name.....</b>	<b>13-7</b>
<b>Loading the saved data files that are on the SD card .....</b>	<b>13-8</b>
<b>Backing up the data stored on the SD card onto a PC .....</b>	<b>13-10</b>
◇ About the SD card's folder contents .....	13-10
◇ Making a backup file on your PC.....	13-11
<b>Updating the repeater list .....</b>	<b>13-12</b>
<b>Cloning Transceiver-to-Transceiver using an SD card.....</b>	<b>13-15</b>

## About the SD card

The SD and SDHC cards are not available from Icom. Purchase locally.

An SD card of up to 2 GB or an SDHC of up to 32 GB, can be used with the IC-7100. Icom has checked the compatibility with the following SD and SDHC cards.

(As of June 2013)

Brand	Type	Memory size
SanDisk®	SD	2 GB
	SDHC	4 GB
		8 GB
		16 GB
		32 GB

- The above list does not guarantee the card's performance.
- Through the rest of this document, the SD card and an SDHC card are simply called SD cards.
- Icom recommends that you format all SD cards to be used with the IC-7100, even preformatted SD cards for PCs or other uses.

**NOTE:**

- Read the instructions of the SD card thoroughly before use.
- **NEVER** remove the SD card or turn OFF the transceiver, while reading or writing data to or from the SD card, or during cloning. It will cause the data to be corrupted or damage the card.
- **NEVER** drop, impact or apply vibration to the SD card. This will cause the data to be corrupted or damage the card.
- The SD card will get warm if used continuously for a long period of time.
- An SD card has a certain lifetime, so data reading or writing may not be possible when using it over a long time period.
- When reading or writing data is impossible, the SD card's lifetime has ended. In this case, purchase a new one. We recommend you make a backup file of the important data onto your PC.
- Icom will not be responsible for any damage caused by data corruption of an SD card.

- ▨ Saving the factory default data is recommended.
  - ➔ Insert the card into the transceiver's slot, and then push **SET**(**C**) to enter the Set mode.
  - Touch "SD Card," then "Save Setting" to save.

### Saving data onto the SD card

The following data can be stored onto the card:

- **Data settings of the transceiver**

Memory channel contents, and repeater lists stored in the transceiver.

- **Communication contents**

The transmitted and received audio.

- **Communication log**

The communication and receive history log.

- **Automatic answering voice audio for the DV mode**

Voice audio to use with the Auto Reply function in the DV Mode.

- **Voice audio for the Voice TX function**

Voice audio to use with the Voice TX function.

- **RTTY decode log**

The transmitted or received RTTY decode history log.

## Inserting the SD card

- ① Turn OFF the transceiver.
- ② Insert the card into the slot until it locks in place, and makes a 'click' sound.
  - "■" appears when the SD card is inserted.
  - "■" and "□" alternately blink while accessing the SD card.

**NOTE:** Before inserting, be sure to check the card direction.  
If the card is forcibly or inversely inserted, it will damage the card and/or the slot.

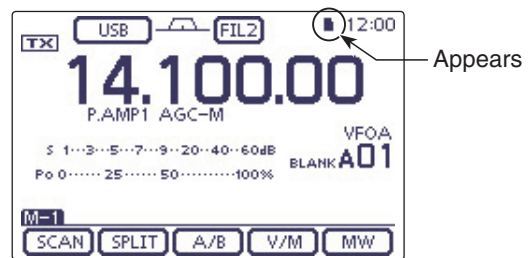
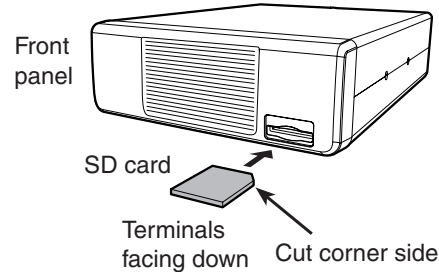

### ◇ Formatting the SD card

- If you use a brand new SD card, format it, by doing the following steps.
- **Formatting a card erases all its data.** Before formatting any programmed card, make a backup file onto your PC.

- ① Turn OFF the transceiver, and then insert the card into the slot.
- ② Turn ON the transceiver.
  - "■" appears when the SD card is inserted.
- ③ Push **SET**(C) to enter the Set mode.
- ④ Touch the "SD Card" Set mode.
  - If the specified item is not displayed, touch [▲] or [▼](D) one or more times to select the page.
- ⑤ Touch the "Format" item.
  - The confirmation screen "Format OK?" appears.
- ⑥ Touch **[YES]**(D).
  - The formatting starts and the display shows the formatting progress.
  - After formatting ends, the display automatically returns to the screen displayed before touching **[YES]**(D).

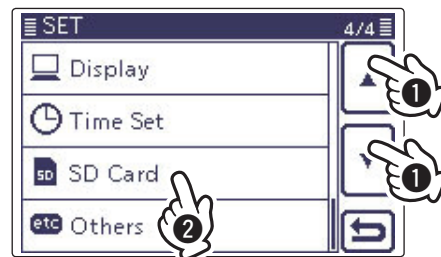
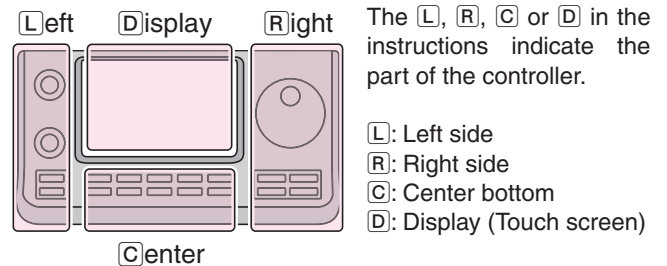

## Removing the SD card

- ① Turn OFF the power.
- ② Push in the SD card until a click sounds, and then carefully pull it out.

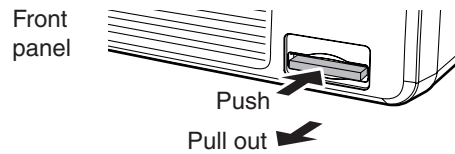

### ◇ Removing the SD card while the transceiver's power is ON

- ① Push **SET**(**C**) to enter the Set mode.
- ② Touch the "SD Card" Set mode.
  - If the specified item is not displayed, touch [**▲**] or [**▼**](**D**) one or more times to select the page.
- ③ Touch the "Unmount" item.
  - The confirmation screen "Unmount OK?" appears.
- ④ Touch **[YES]**(**D**).
- ⑤ Push in the SD card until a click sounds, and then carefully pull it out.

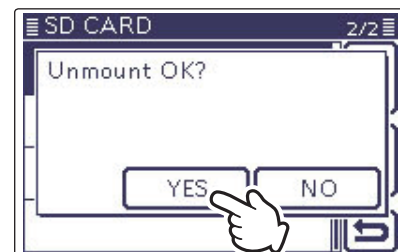
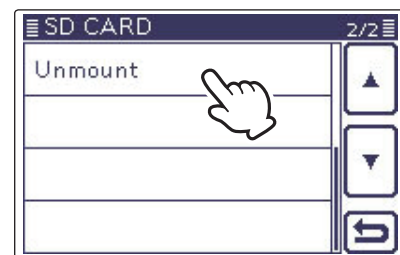
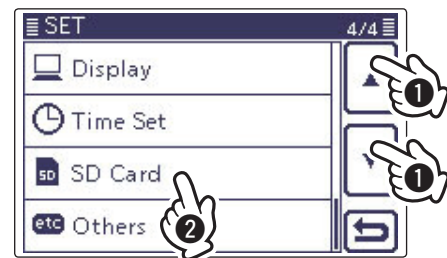
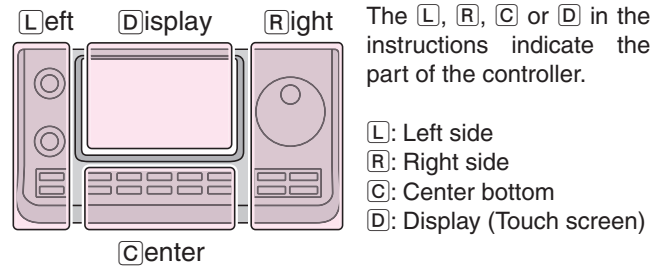

## Saving the setting data onto an SD card

Memory channels, Set mode item settings, and repeater lists can be saved on the SD card. Saving data settings on the SD card allows you to easily restore the transceiver to its previous settings, even if an All reset is performed.

### ✓ For your information

Data settings are saved in the “icf” file format that is used in the CS-7100 cloning software. The saved data on the SD card can be copied onto a PC and edited by the cloning software.

Data settings can be saved as a new file or to overwrite an older file.

### Saved as a new file

- ① Push **SET**(**C**) to enter the Set mode.
- ② Touch the “Save Setting” item of the “SD Card” Set mode.  
(SD Card > **Save Setting**)
  - If the specified item is not displayed, touch [**▲**] or [**▼**](**D**) one or more times to select the page.
- ③ Touch “<<New File>>.”
  - The “FILE NAME” screen appears.
  - The file name is automatically named in the following manner; Setyyyyymmdd\_xx (yyyy: Year, mm: month, dd: day, xx: serial number)  
**Example:** If a second file is saved on March 1, 2013, the file is named “Set20130301\_02.”
  - If you want to change the file name, see “Save with a different file name” (p. 13-7).
- ④ Touch **[ENT]**(**D**) to save the file name.
  - The confirmation screen “Save file?” appears.
- ⑤ Touch **[YES]**(**D**) to save.
  - While saving, a progress bar is displayed, then the “SD CARD” screen is displayed after the save is completed.
- ⑥ Push **SET**(**C**) to exit the Set mode.

### Overwriting a file

(**Example:** Overwriting the “Set20130301\_01”)

- ➔ Select the desired file to be overwritten in step ③ as described above.  
(**Example:** Selecting “Set20130301\_01”)

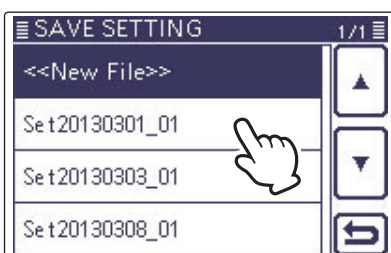
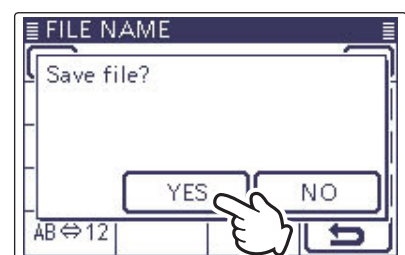
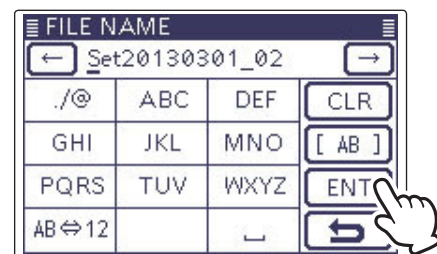
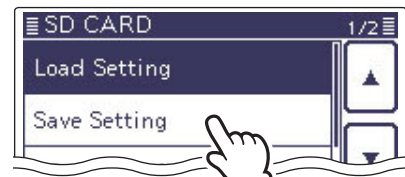
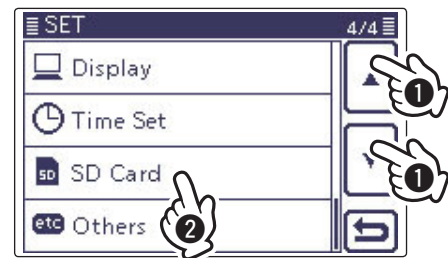
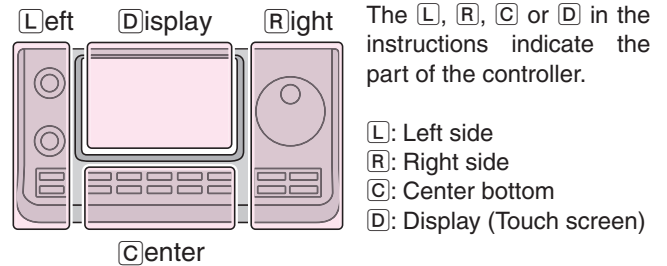



## Saving with a different file name

- ① Push **SET**(**C**) to enter the Set mode.
- ② Touch the “Save Setting” item of the “SD Card” Set mode.  
(SD Card > **Save Setting**)
  - If the specified item is not displayed, touch **[▲]** or **[▼]**(**D**) one or more times to select the page.
- ③ Touch “<<New File>>.”
  - The “FILE NAME” screen appears.
- ④ Touch **[CLR]**(**D**) to delete the previously programmed character.
  - Touch **[CLR]**(**D**) to delete the selected character, symbol or number.
  - When the cursor does not select a character, the previous character is deleted.
  - If **[CLR]**(**D**) is continuously touched, all the characters are deleted.
- ⑤ Touch the desired block one or more times to select the desired character or symbol.
 

**Selectable characters and symbols**

A to Z, a to z, 0 to 9, ! # \$ % & ' ` ^ + - . , = ( ) [ ] { } \_ ` @ (space)

  - Touch “AB↔12” to toggle between the Alphabet input and Number input mode.
  - Touch **[CLR]**(**D**) to delete the selected character, symbol or number.
  - Touch “\_” to input a space.
- ⑥ Touch **[←]**(**D**) to move the cursor backwards, or touch **[→]**(**D**) to move the cursor forwards.
- ⑦ Repeat steps ⑤ and ⑥ to program up to 15 characters name.
  - Example: MY DATA
- ⑧ Touch **[ENT]**(**D**) to save the name.
  - The confirmation screen “Save file?” appears.
- ⑨ Touch **[YES]**(**D**) to save.
  - While saving, a progress bar is displayed, then the “SD CARD” screen is displayed after the save is completed.
- ⑩ Push **SET**(**C**) to exit the Set mode.

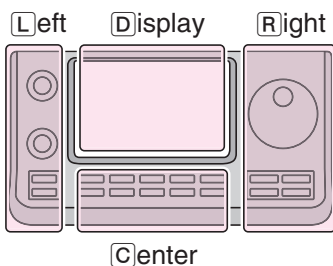
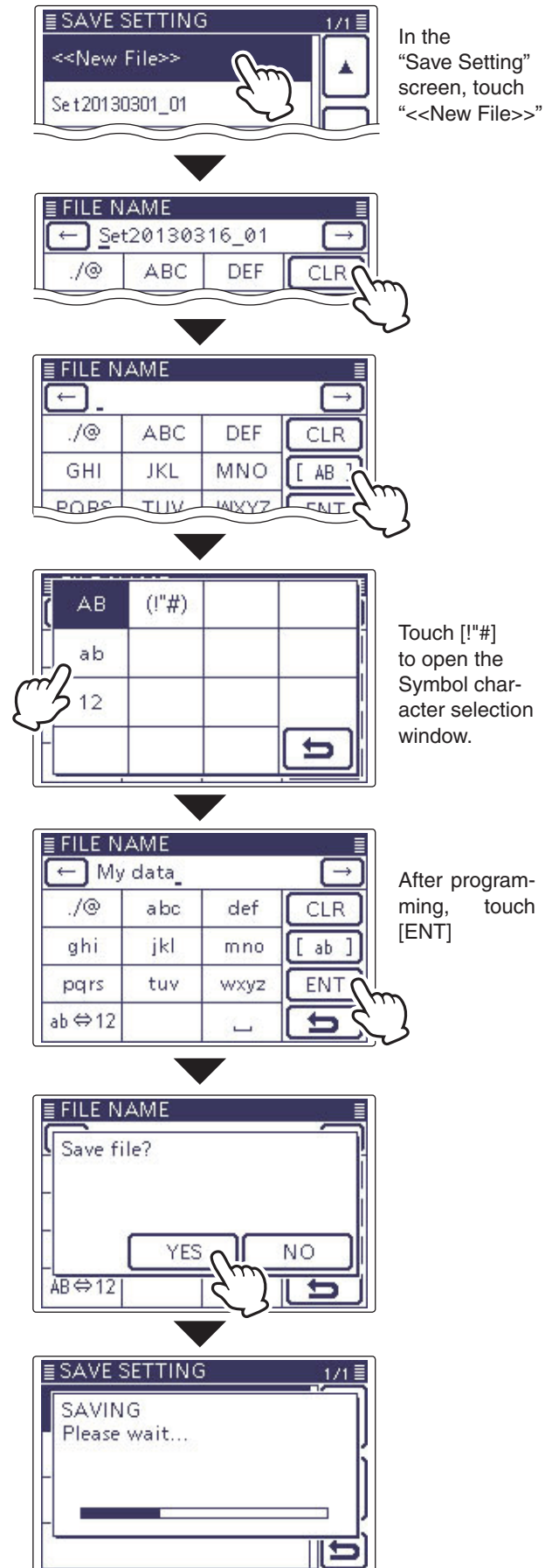

The **L**, **R**, **C** or **D** in the instructions indicate the part of the controller.

- L**: Left side
- R**: Right side
- C**: Center bottom
- D**: Display (Touch screen)

## Loading the saved data files that are on the SD card

The saved memory channels, Set mode item settings and repeater lists can be copied to the transceiver. This function is convenient when copying the saved data, such as memory channels, or repeater lists, to another IC-7100 and then operating with the same data.

Saving the current data is recommended before loading other data in the transceiver.

**(Example:** Loading all the data in the “Set20130301\_01” file)

- ① Push **SET**(**C**) to enter the Set mode.
- ② Touch the “Load Setting” item of the “SD Card” Set mode.  
(SD Card > **Load Setting**)
  - If the specified item is not displayed, touch [**▲**] or [**▼**](**D**) one or more times to select the page.
- ③ Touch the desired file to be loaded.  
**(Example:** Selecting “Set20130301\_01”)
- ④ Touch the desired loading option, as shown below.
  - **ALL:**  
Loads all memory channels, item settings in the menu list and the repeater list into the transceiver.
  - **Select:**  
Loads all memory channels, Set mode item settings and the repeater list into the transceiver.  
“MY call signs” and “REF Adjust” settings can be selected to be loaded.
  - **Repeater List Only:**  
Loads only the repeater list into the transceiver.
- ⑤ The “Keep ‘SKIP’ settings in Repeater List?” appears. Touch [**YES**], [**NO**] or [**Cancel**](**D**).
  - When [**YES**](**D**) is touched, the skip settings of the repeater list are retained. (p. 9-34)
  - When [**NO**](**D**) is touched, the skip settings of the repeater list are not retained. (p. 9-34)
  - When [**Cancel**](**D**) is touched, returns to the LOAD FILE screen.
  - When [**YES**] or [**NO**](**D**) is touched, “Load file?” appears.

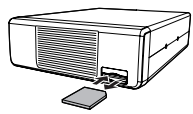
To update the repeater list, click here! 

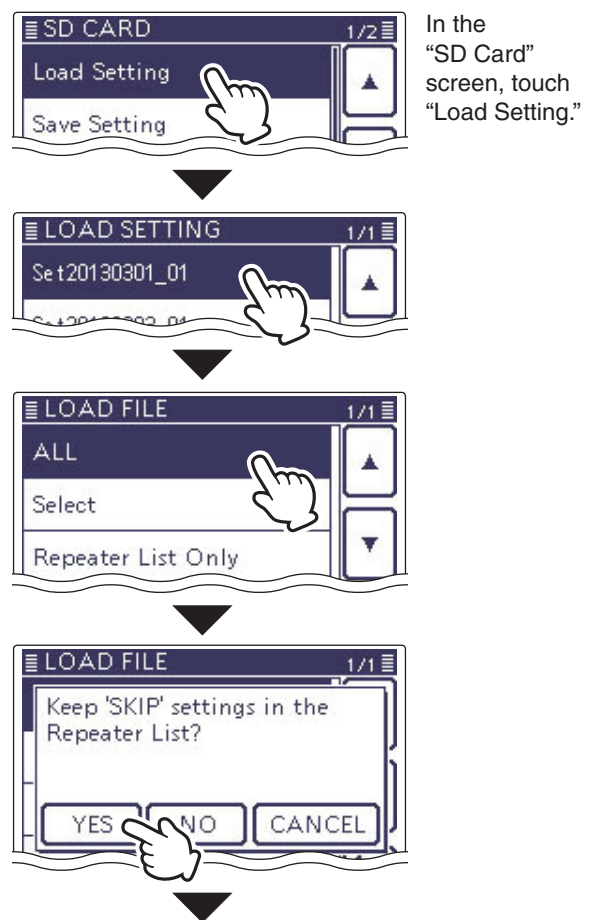
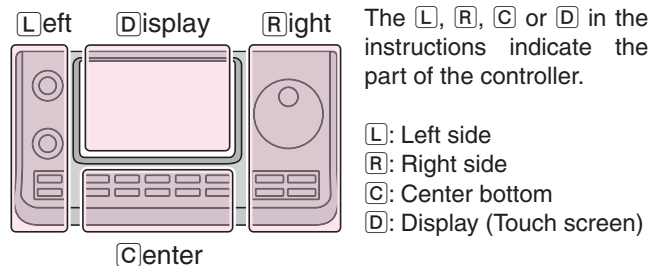

➤ Continued on the next page

**Loading the saved settings file that are on the SD card (Continued)**

- ⑥ Touch [YES](D) to start the file check.
  - While checking the file, "CHECKING FILE" and a progress bar are displayed.
- ⑦ After checking, settings data loading begins.
  - While loading, "LOADING" and a progress bar are displayed.
- ⑧ After loading ends, "COMPLETED!" appears.
  - To complete the loading, reboot the transceiver.

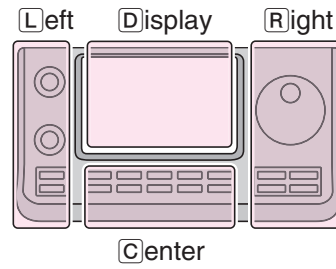

The [L], [R], [C] or [D] in the instructions indicate the part of the controller.

- [L]: Left side
- [R]: Right side
- [C]: Center bottom
- [D]: Display (Touch screen)

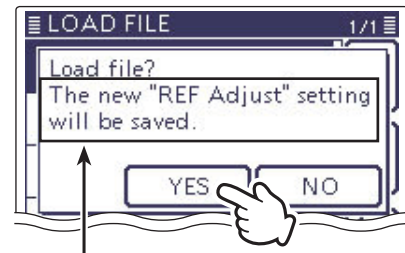

Appears only when "ALL" or "Select"\* is selected in the LOAD FILE screen,  
 \*If "Select" is selected, only when the "REF Adjust" check box is checked.



## Backing up the data stored on the SD card onto a PC

A backup file allows easy restoring even if the setting data in the SD card is accidentally deleted.

Depending on your PC, a memory card reader (purchase locally) may be additionally required to read the SD card.

### ◆ About the SD card's folder contents

The folder in the SD card contains the following:

- ① IC-7100 folder  
The folders created in the IC-7100 are contained in this IC-7100 folder.
- ② Decode folder  
The RTTY decode folder is created.
- ③ RTTY folder  
The transmitted or received RTTY decode data is stored in the "txt" format.  
The file format can be changed to "html" in the RTTY DECODE LOG SET screen.
- ④ QSO Log  
QSO log data is stored in the "csv" format.
- ⑤ Reply folder  
Automatic reply data is stored in the "wav" format.
- ⑥ RxLog  
RX record log data is stored in the "csv" format.
- ⑦ Setting folder  
The transceiver's setting data is stored in the "icf" format.
- ⑧ Voice folder  
The recorded QSO audio data folders are created in the Voice folder.
- ⑨ yyyyymmdd folder  
Recorded audio file is stored in the "wav" format.  
The folder name is automatically created in the following format:  
yyyyymmdd (yyyy:Year, mm:month, dd:day)
- ⑩ VoiceTx  
Recorded voice audio data for the Voice TX function is stored in the "wav" format.

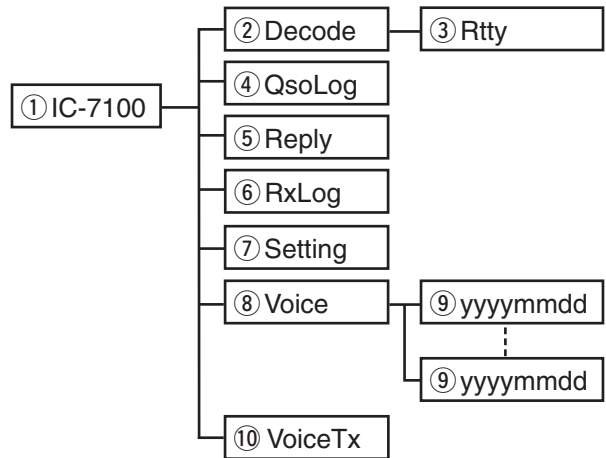

### (Example: Selecting the setting data)

When the SD card is inserted into the SD card drive of your PC or the SD card reader (purchase locally), the screen appears as shown below.

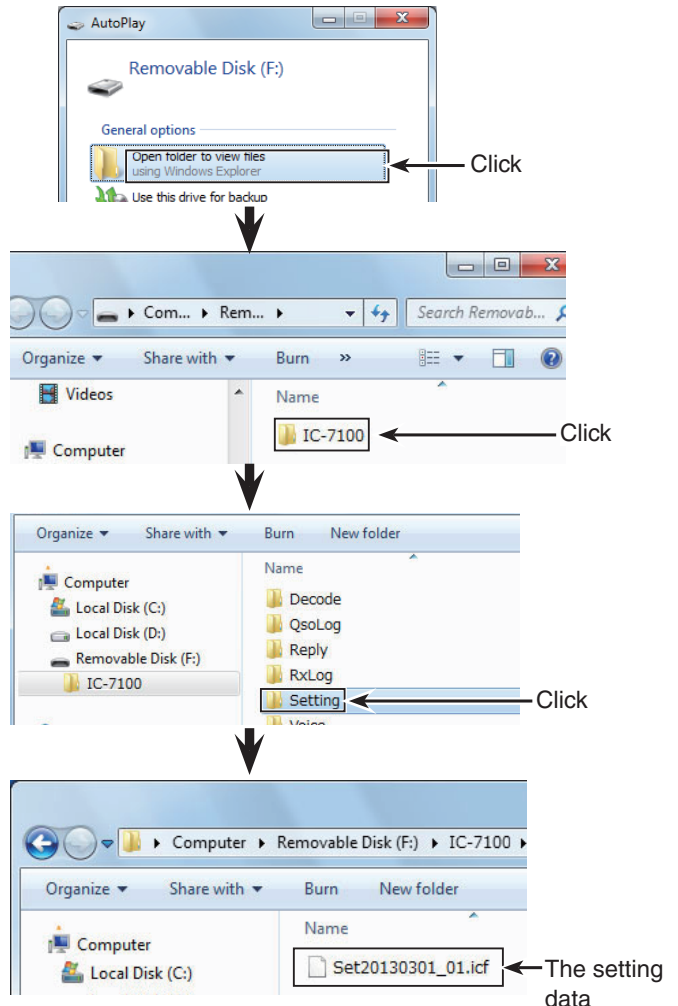

Backing up the data stored on the SD card onto a PC (Continued)

◆ Making a backup file on your PC

Windows 7 is used for these instructions.

- ① Insert the SD card into the SD card drive on your PC.
  - If no SD card drive is built-in, connect a memory card reader (purchase locally) and then insert the SD card into it.
- ② Click the “Open folder to view files” option to access the card.

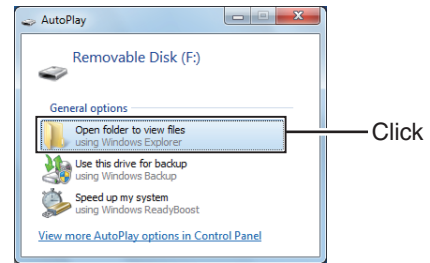

- ③ Select “Removal disk” and right click.
- ④ Click “Copy.”

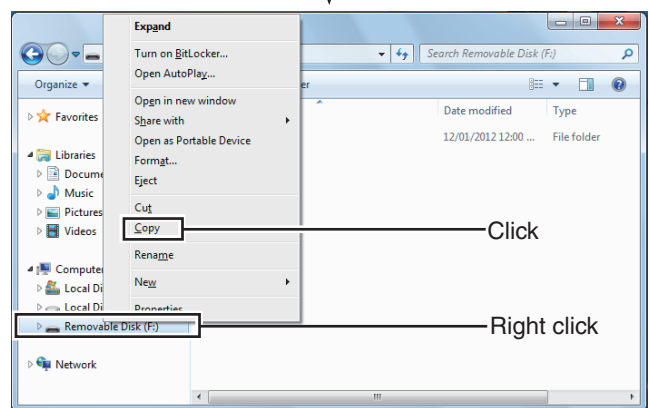

- ⑤ Open the desired folder to copy to, then right click, then click “Paste” to copy the data that is in the SD card onto the hard disk.
 

(**Example:** Copying into the “Backup” folder in C drive)

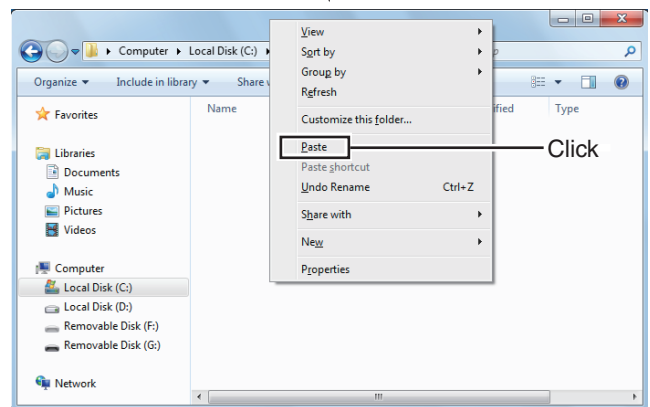

- ⑥ When removing the SD card from your PC, click the SD card icon in the task bar. (“Eject” icon in the screen shot as shown to the right.)
  - The screen shot shows when a memory card reader is connected.

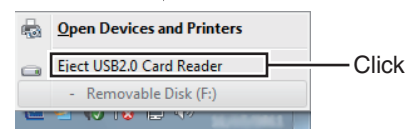

- ⑦ Remove the SD card from your PC when “Safe To Remove Hardware” appears.
  - The screen shot shows when a memory card reader is connected.

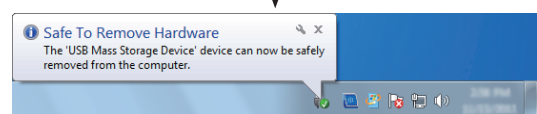

## Updating the repeater list

For easy operation, the repeater list is preloaded into your transceiver.

This section describes how to manually update the repeater list using an SD card.

The latest setting file, which includes the repeater list, can be downloaded from the Icom website.

### 1. Downloading the latest setting file (ICF file)

1 Access the following URL to download the latest data.

<http://www.icom.co.jp/world/support/download/firm/index.html>

- The latest settings file (ICF file) and repeater list (CSV; Comma Separated Values file) are contained in the downloaded ZIP file.

File Name: 7100\_U\_130301.zip

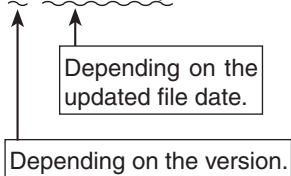

▨ This instruction manual describes when the file name is “7100\_U\_130301.zip,” for example.

2 Decompress the compressed file that is downloaded from the Icom website.

“7100\_U\_130301” folder will be created in the same place where the downloaded file is saved.

### 2. Inserting the SD card into a PC

3 Insert the SD card into the SD card drive on your PC.

- Icom recommends that you format all SD cards to be used with the IC-7100, even preformatted SD cards for PCs or other uses.

See page 13-4 and 13-5 for details of inserting and removing the SD card.

### 3. Copying the latest ICF file to the SD card

4 Double-click the “7100\_U\_130301” folder created in the same place where the downloaded file is saved.

5 Copy the ICF file (Example: “7100\_USA\_130301.icf”) in the folder to the “Setting” folder in the “IC-7100” folder of the SD card.

➤ Continued on the next page

IC-7100’s latest setting file is uploaded to “Cloning software(Rev. \*\* ) and manuals” in the Icom website screen.

- The displayed contents may differ.

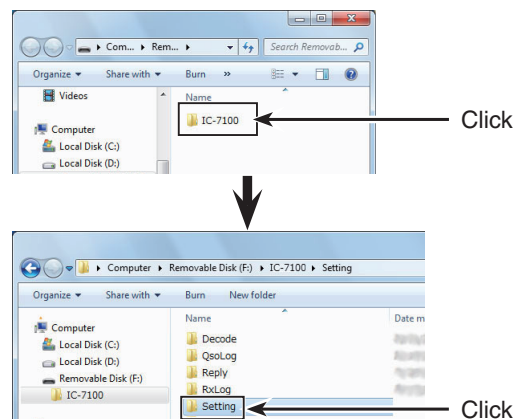
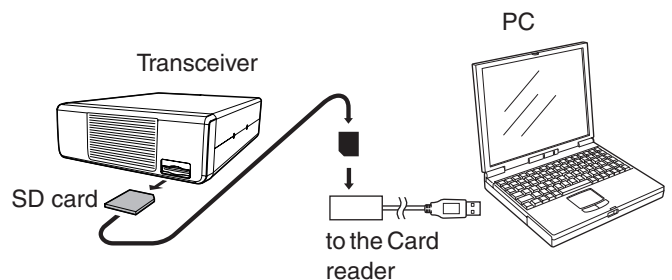
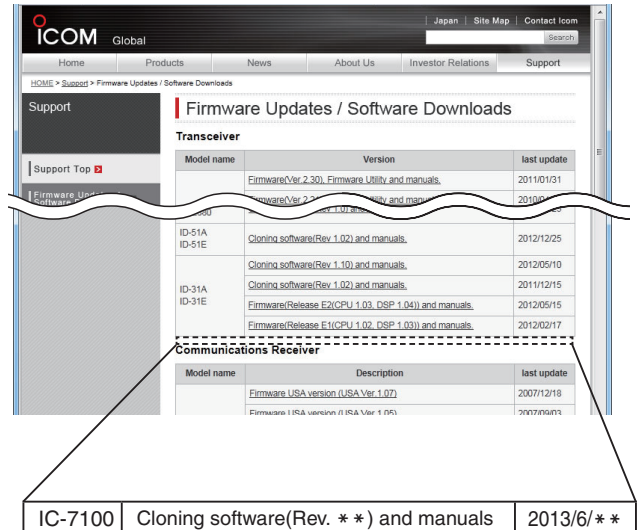



Updating the repeater list (Continued)

4. Inserting the SD card

- 6 Remove the SD card from your PC, and insert the card into the transceiver's slot.

See page 13-4 for details of inserting the SD card into the transceiver.

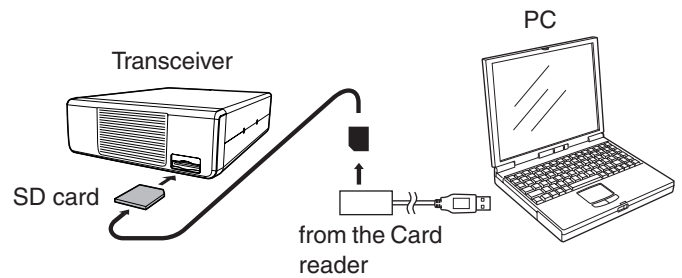

Saving the current data is recommended before loading other data into the transceiver.

5. Updating the repeater list

- 7 Push **SET**(C) to enter the Set mode.
- 8 Touch the "Load Setting" item of the "SD Card" Set mode.  
(SD Card > **Load Setting**)
  - If the specified item is not displayed, touch **▲** or **▼**(D) one or more times to select the page.
- 9 Touch the ICF file to be loaded.  
(**Example:** Selecting "7100\_USA\_130301.icf")
  - The LOAD FILE screen appears.
- 10 Touch "Repeater List Only."
  - The "Keep 'SKIP' settings in Repeater List?" appears.
  - Loads only the repeater list into the transceiver.

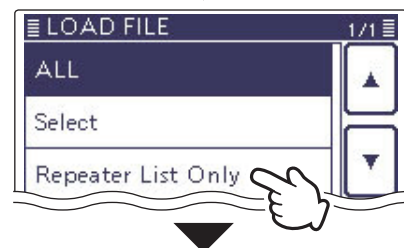
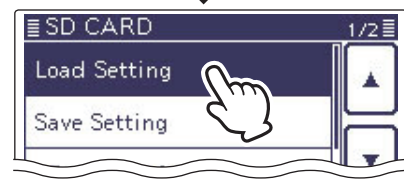
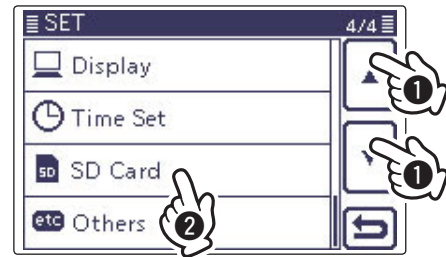
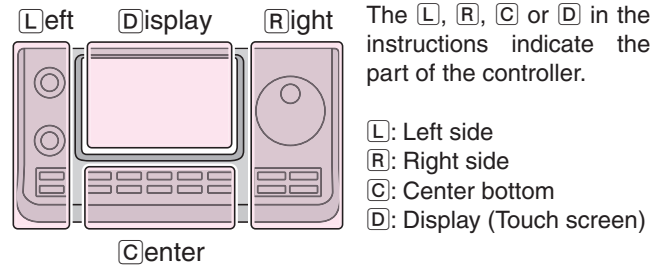

Continued on the next page



Updating the repeater list (Continued)

- 11 Touch [YES], [NO] or [Cancel](D).
  - When [YES](D) is touched, the skip settings of the repeater list are retained. (p. 9-34)
  - When [NO](D) is touched, the skip settings of the repeater list are not retained. (p. 9-34)
  - When [Cancel](D) is touched, returns to the LOAD FILE screen.
  - When [YES] or [NO](D) is touched, "Load file?" appears.
- 12 Touch [YES](D) to start the file check.
  - While checking the file, "CHECKING FILE" and a progress bar are displayed.
- 13 After checking, settings data loading begins.
  - While loading, "LOADING" and a progress bar are displayed.
- 14 After loading ends, "COMPLETED!" appears.
  - To complete the loading, reboot the transceiver.

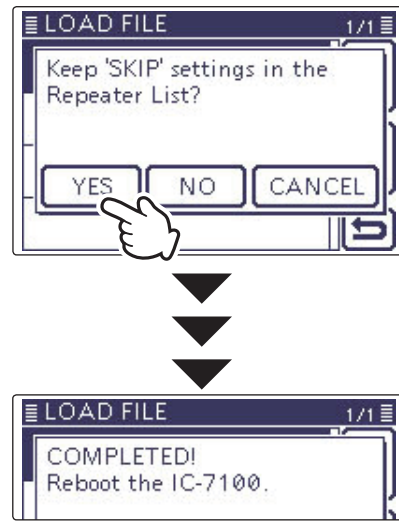
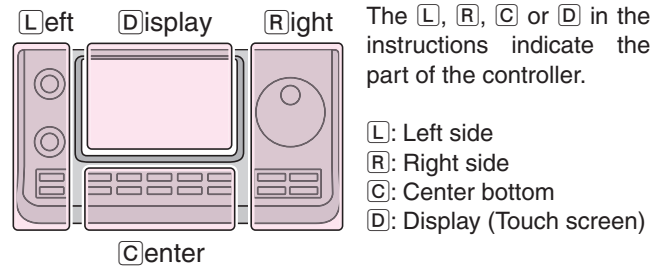

**Repeater list updating is complete!**

## Cloning Transceiver-to-Transceiver using an SD card

This topic describes the cloning method using the SD card.

Memory channel contents, Set mode item settings and repeater list can be saved onto an SD card.

Recorded voice memories are not included in the cloning data. To play back the master transceiver's voice memory, insert the SD card into sub transceiver, or make a copy onto the sub transceiver's SD card using a PC.

⚡ Description is with the SD card is already inserted.

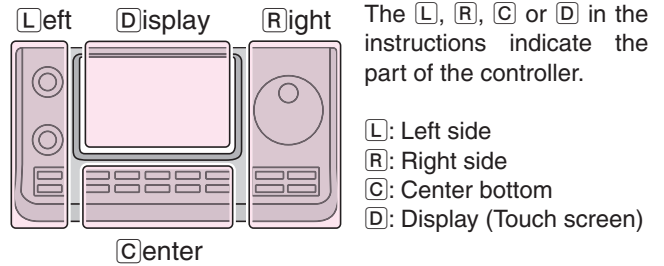
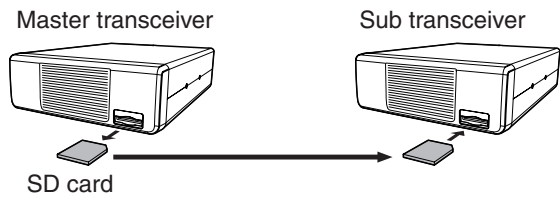

### 1. Saving the master transceiver's setting data onto the SD card.

- 1 Save the master transceiver's setting data onto the SD card, as described on page 13-6.

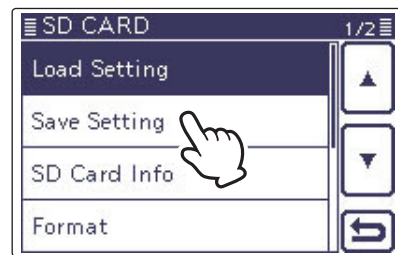

### 2. Remove the SD card from the master transceiver, and then insert it to the sub transceiver.

- 2 Turn OFF the master transceiver's power.
- 3 Remove the SD card from the master transceiver as shown at right.
- 4 Insert the removed SD card into the sub transceiver, then turn ON the sub transceiver's power.

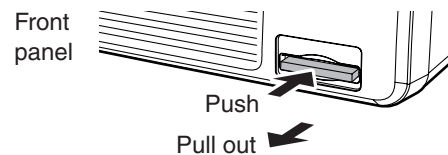

### 3. Loads the setting data into the sub transceiver.

- 5 The master transceiver's setting data loads into the sub transceiver, as described on page 13-8.

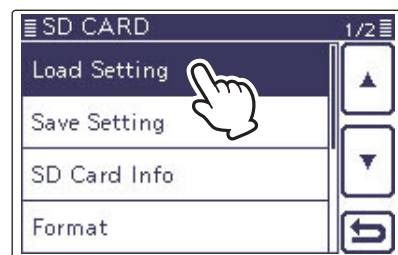

When you load the data, be sure to set the loading content as "Repeater List Only" or "Select" in the LOAD FILE screen, and if "Select" is selected, the "REF Adjust" check box must be cleared. Otherwise, it may result in a frequency deviation.

LOAD FILE screen

Touch "Repeater List Only"

or

LOAD OPTION screen  
(Appears when "Select" is touched in the LOAD FILE screen)

Touch "Load" without checking the "REF Adjust" box.

# Section 14 VOICE MEMORY FUNCTION

---

<b>Recording a QSO audio .....</b>	<b>14-2</b>
◇ To start recording .....	14-2
◇ To stop recording.....	14-2
<b>Changing the recording mode .....</b>	<b>14-3</b>
<b>Playing back the recorded audio .....</b>	<b>14-4</b>
<b>Operation while playing back.....</b>	<b>14-5</b>
◇ Fast forward while playing .....	14-5
◇ Rewind while playing.....	14-5
◇ Pause while playing.....	14-5
◇ Playing the previous file.....	14-5
◇ Playing the next file .....	14-5
◇ Moving to the beginning of the previous file .....	14-5
◇ Moving to the beginning of the next file.....	14-5
◇ VOICE PLAYER screen's descriptions .....	14-5
<b>Changing the skip time.....</b>	<b>14-6</b>
<b>Deleting the recorded contents (audio).....</b>	<b>14-7</b>
<b>Deleting the folder .....</b>	<b>14-8</b>
<b>Continue to record even if no signals are received .....</b>	<b>14-9</b>
<b>Record the transmit and receive audio into the same file.</b>	<b>14-10</b>
<b>Start to record when the [PTT] switch is pushed .....</b>	<b>14-11</b>
<b>Viewing the folder information .....</b>	<b>14-12</b>
<b>Viewing the file information.....</b>	<b>14-13</b>
<b>Viewing the SD card's free space and recordable time .....</b>	<b>14-15</b>
<b>Playing back the voice memory data on a PC .....</b>	<b>14-16</b>

## Recording a QSO audio

The Voice Memory function records a QSO (communication) audio onto the SD card.

This function enables you to record both received and transmitted audio, a QSO with a **DX'pedition**, and playback the recorded audio after the QSO.

**NOTE:** Be sure to insert an SD card into the transceiver before recording a QSO audio.

### ◆ To start recording

- ① Push **QUICK**(**C**) to open the Quick Menu screen.
- ② Touch the “<<REC Start>>” item to start voice recording.
  - Touch **[▼]**(**D**) one or more times to select the desired page.
  - The transceiver displays “Recording started” and automatically exits the Quick Menu screen.
  - “||” appears while the recording is paused.
  - “●” appears and “■” and “□” alternately blink while recording.
  - Recording is continuous until you manually stop recording, or the card becomes full.
  - If the recording file’s content reaches 2GB, the transceiver automatically creates a new file, and continues recording.

**NOTE:** Once recording has started, it will continue, even if the transceiver is rebooted.

### ✓ Convenient!

When the PTT Automatic Recording function is set to ON, the recording automatically starts when [PTT] is pushed. (p. 17-12)  
 (Voice Memo > QSO Recorder > Recorder Set > **PTT Auto REC**)

### ◆ To stop recording

- ① Push **QUICK**(**C**) to open the Quick Menu screen.
- ② Touch “<<REC Stop>>” to stop voice recording.
  - Touch **[▼]**(**D**) one or more times to select the desired page.
  - The transceiver displays “Recording stopped,” and automatically exits the Quick Menu screen.

When touching either the “●” or “||” icons, the Confirmation “Stop recording?” appears. And then touch **[YES]**(**D**) also stops recording.

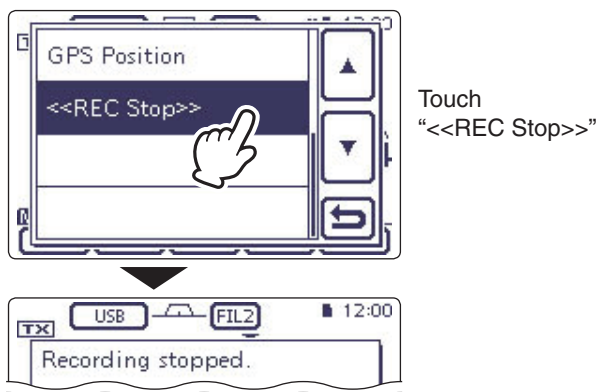
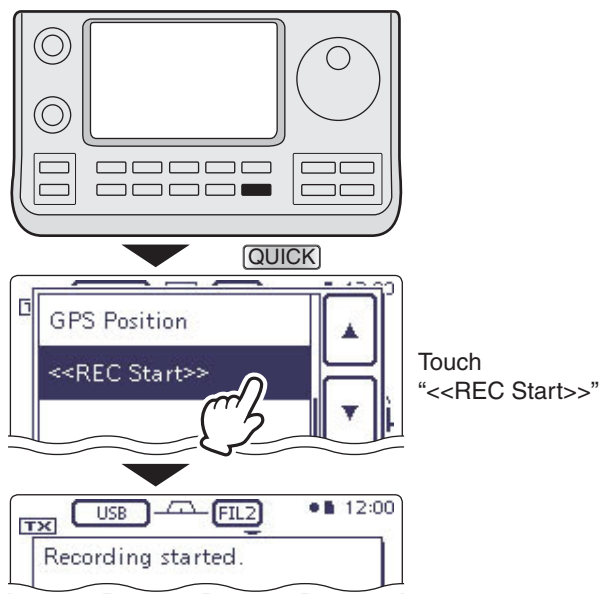
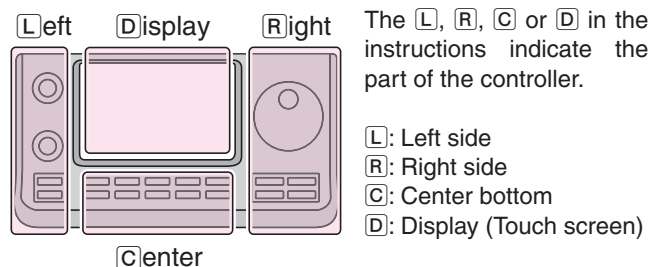

## Changing the recording mode

You can change the recording mode in the Set mode to record only the received audio.

/// The default setting is "TX&RX" (Both transmit and receive signals are recorded).

- ① Push **SET**(C) to enter the Set mode.
- ② Touch the "REC Mode" item of the "Voice Memo" Set mode.  
(Voice Memo > QSO Recorder > Recorder Set > **REC Mode**)
  - If the specified item is not displayed, touch [▲] or [▼](D) one or more times to select the page.
- ③ Touch "RX Only" to save, and return to the previous screen.
- ④ Push **SET**(C) to exit the Set mode.

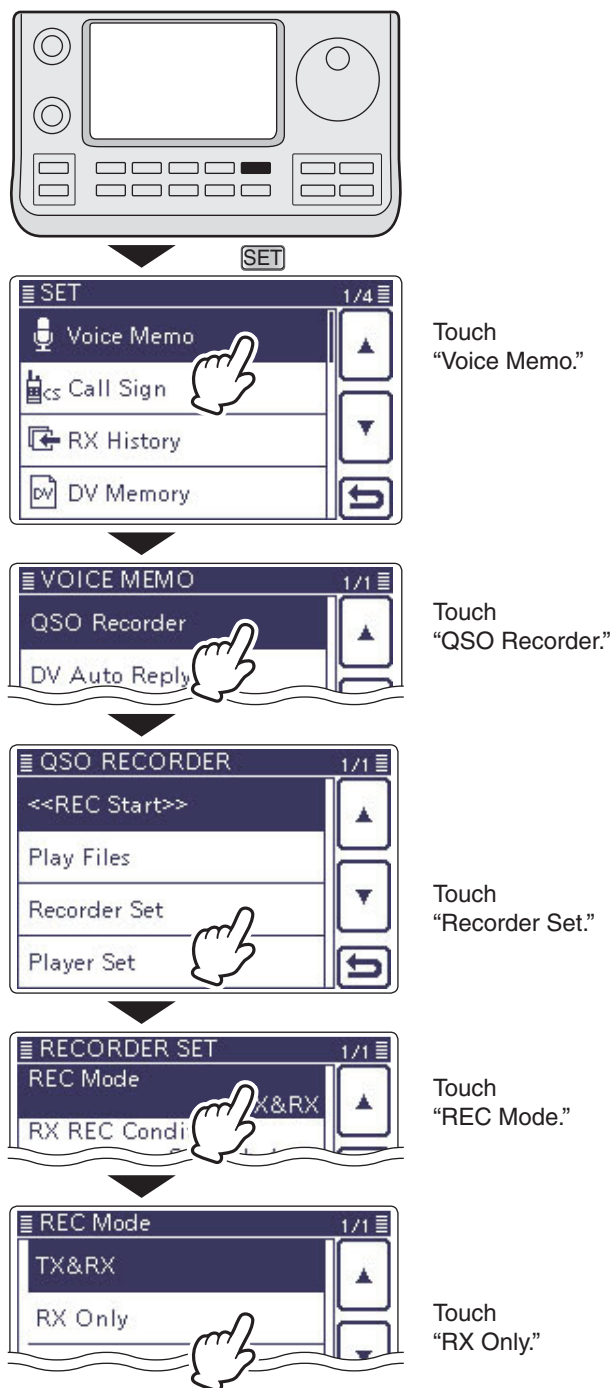

## Playing back the recorded audio

- ① Push **SET**(**C**) to enter the Set mode.
- ② Touch the "Play Files" item of the "Voice Memo" Set mode.  
 (Voice Memo > QSO Recorder > **Play Files**)
  - If the specified item is not displayed, touch [**▲**] or [**▼**](**D**) one or more times to select the page.
  - The folder list is displayed. (The folders are automatically made when the recording starts.)
  - The folder name is formatted yyyyymmdd (y: year, m: month, d: day.)
- ③ Touch the folder that contains the file you want to play.
  - The file list is displayed.
  - The file name is formatted yyyy/mm/dd hh:mm:ss (y: year, m: month, d: day, hh: hour, mm: minute, ss: second.)
- ④ Touch the file that you want to play.
  - The VOICE PLAYER screen is displayed, and the file starts to playback.
- ⑤ Touch [**↶**](**D**) or push **MENU**(**C**) to stop the playback, and return to the file list screen.



While playing back

## Operation while playing back

You can fast forward or rewind while playing back.

### ◇ Fast forward while playing

Touch **[▶▶]** to fast forward to the skip time point.  
(Default: 10 seconds)

If you want to change the skip time, see “Changing the skip time.” (p. 14-6)

### ◇ Rewind while playing

Touch **[◀◀]** to rewind to the skip time point.  
(Default: 10 seconds)

If you want to change the skip time, see “Changing the skip time.” (p. 14-6)

- If you touch **[◀◀]** within the first second of the file, the skip time at the end of the previously recorded file will playback.

### ◇ Pause while playing

Touch **[⏸]** to pause.

- While pausing, **[▶▶]** appears.

Touch **[▶▶]** to resume.

### ◇ Playing the previous file

Touch **[◀◀]** to play the previous file.

- In case there are other files in the folder, while the oldest file is playing back, touch **[◀◀]** to start playing the beginning of the file.

### ◇ Playing the next file

Touch **[▶▶]** to play the next file.

- In case there are other files in the folder, while the most recent file is playing back, touch **[▶▶]** to stop the playback.

### ◇ Moving to the beginning of the previous file

When the playback is paused anywhere within the file, touch **[◀◀]** one or more times to return to the beginning of the file, and pause.

- Touch **[▶▶]** to play it back.

When the playback is paused at beginning of a file, touch **[◀◀]** to move to the beginning of the previous file, and pause.

- Touch **[▶▶]** to play it back.

### ◇ Moving to the beginning of the next file

When the playback is paused, touch **[▶▶]** to move to the beginning of the next file, and pause.

- Touch **[▶▶]** to play it back.

### ✓ Convenient!

You can fast forward or rewind the file that is playing by rotating the Dial.

The fast forward/rewind time is one twentieth of the total file time, regardless of the skip time setting.

### ◇ VOICE PLAYER screen's descriptions

The VOICE PLAYER screen is shown below.

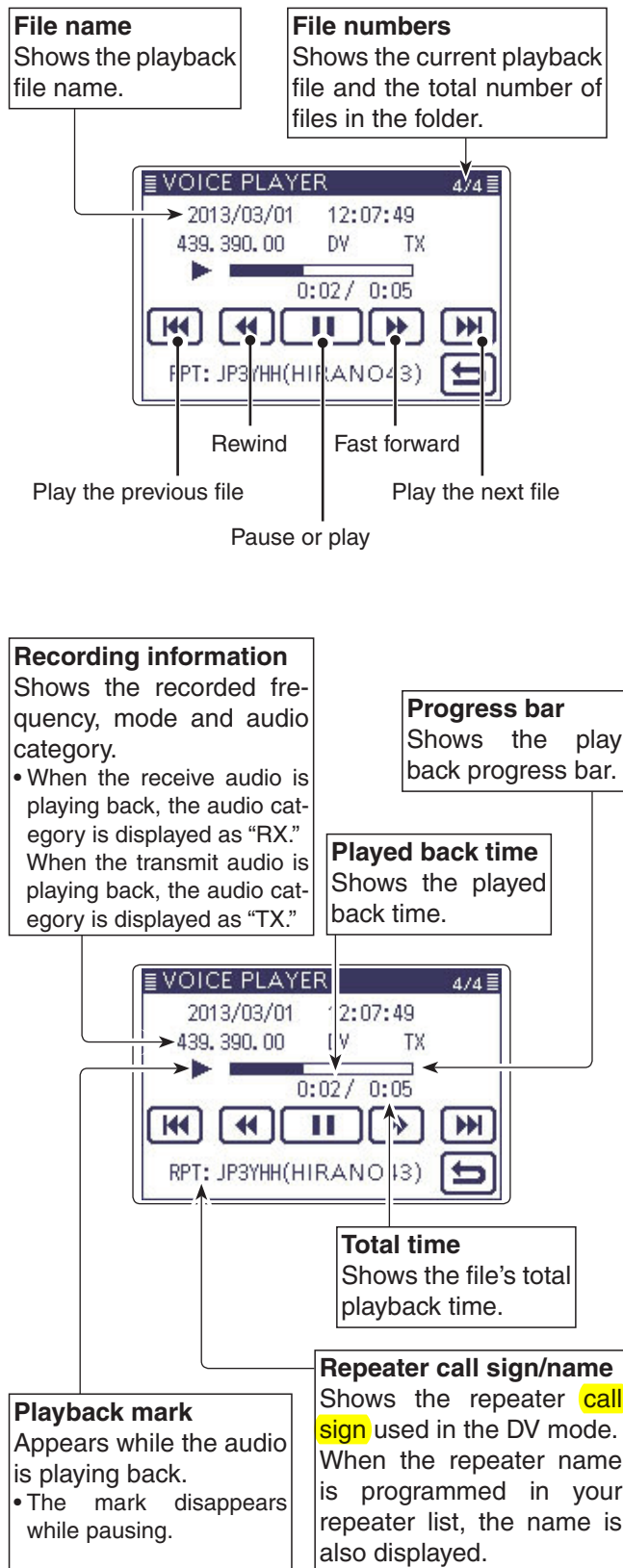



## Changing the skip time

You can change the fast forward and rewind skip time while playing.

- ① Push **SET**(C) to enter the Set mode.
- ② Touch the "Skip Time" item of the "Voice Memo" Set mode.  
(Voice Memo > QSO Recorder > Player Set > **Skip Time**)
  - If the specified item is not displayed, touch **[▲]** or **[▼]**(D) one or more times to select the page.
- ③ Touch the desired skip time of 3, 5, 10 or 30 seconds to save, and return to the previous screen.
- ④ Push **SET**(C) to exit the Set mode.

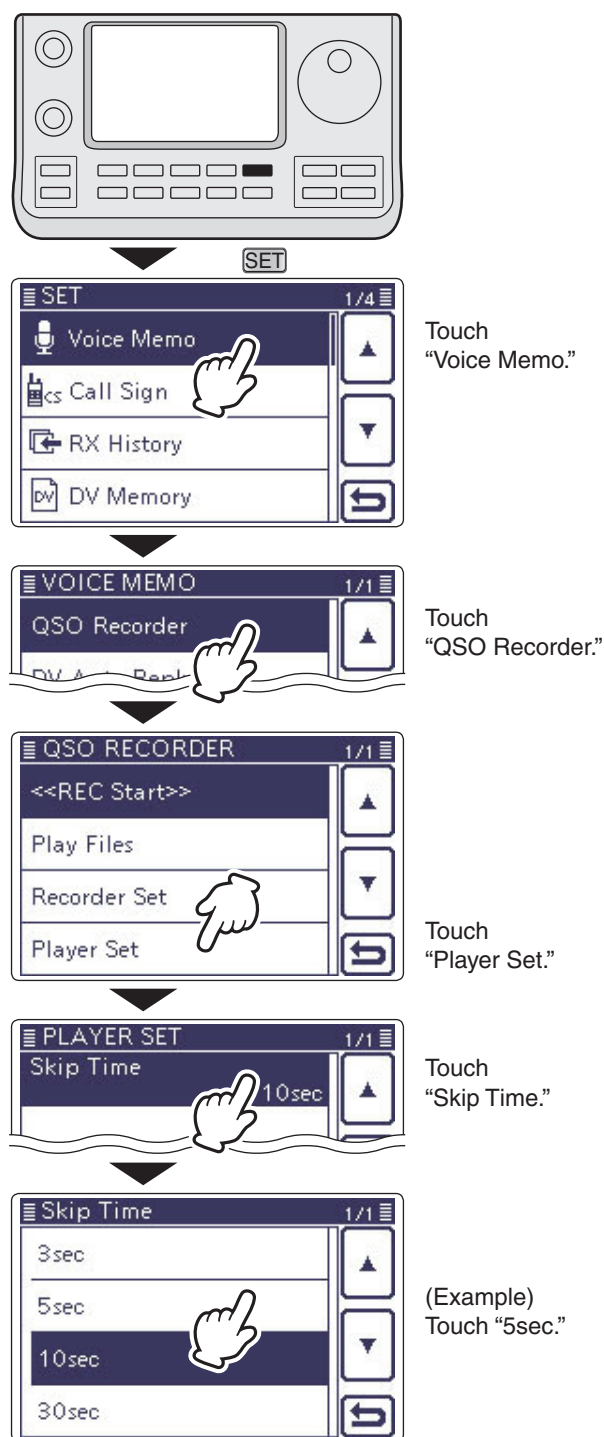
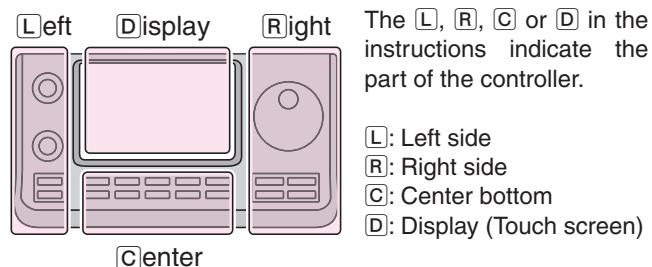

## Deleting the recorded contents (audio)

- ① Push **SET**(**C**) to enter the Set mode.
- ② Touch the "Play files" item of the "Voice Memo" Set mode.  
(Voice Memo > QSO Recorder > **Play files**)
  - If the specified item is not displayed, touch [**▲**] or [**▼**](**D**) one or more times to select the page.
  - The folder list is displayed. (The folders are automatically made when recording starts.)
  - The folder name is formatted yyyyymmdd (y: year, m: month, d: day.)
- ③ Touch the folder including the file that you want to delete.
  - The file list is displayed.
  - The file name is formatted yyyy/mm/dd hh:mm:ss (y: year, m: month, d: day, hh: hour, mm: minute, ss: second.)
- ④ Touch the file that you want to delete for 1 second.
- ⑤ Touch "Delete."  
 • The confirmation screen "Delete file?" appears.
- ⑥ Touch "YES."  
 • The selected file is deleted.
- ⑦ Push **SET**(**C**) to exit the Set mode.

The **L**, **R**, **C** or **D** in the instructions indicate the part of the controller.

**L**: Left side, **R**: Right side, **C**: Center bottom  
**D**: Display (Touch screen)

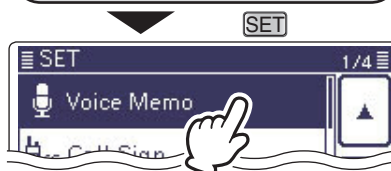
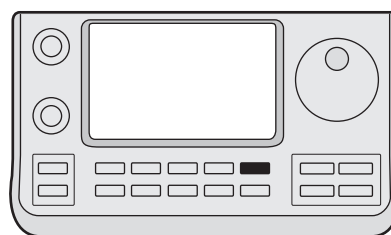

Touch "Voice Memo."

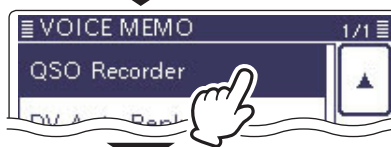

Touch "QSO Recorder."



Touch "Play files."



Touch the folder including the file that you want to delete.



Touch the file that you want to delete for 1 second



Touch "Delete."



Touch "YES."

### <To delete all files>

When you want to erase all audio files in the folder at one time, select "Delete All" in step ⑤ above.

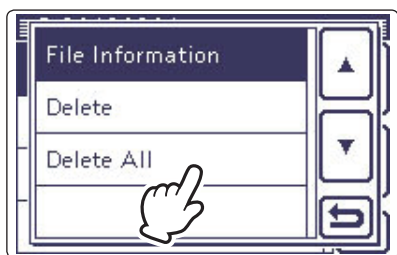

## Deleting the folder

⚡ **NOTE:** All the files in the folder are also deleted.

- ① Push **SET**(C) to enter the Set mode.
- ② Touch the “Play files” item of the “Voice Memo” Set mode.
  - (Voice Memo > QSO Recorder > **Play files**)
  - If the specified item is not displayed, touch [▲] or [▼](D) one or more times to select the page.
  - The folder list is displayed. (The folders are automatically made when recording starts.)
  - The folder name is formatted yyyyymmdd (y: year, m: month, d: day.)
- ③ Touch the folder that you want to delete for 1 second.
- ④ Touch “Delete.”
  - The confirmation screen “Delete folder?” appears.
- ⑤ Touch “YES.”
  - The selected folder is deleted.
- ⑥ Push **SET**(C) to exit the Set mode.

### <To delete all folders>

When you want to erase all folders at one time, select “Delete All Folders” in step ④.

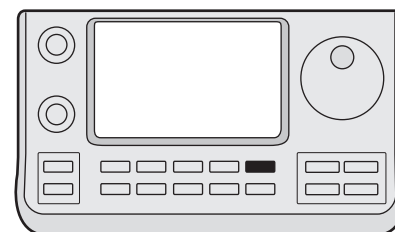
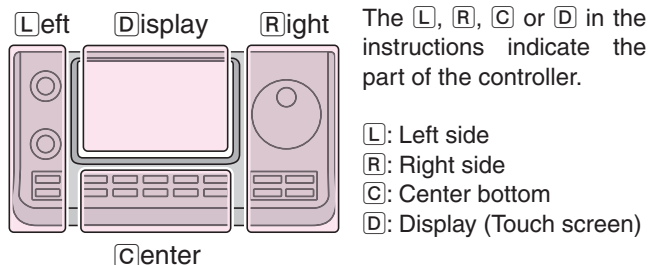
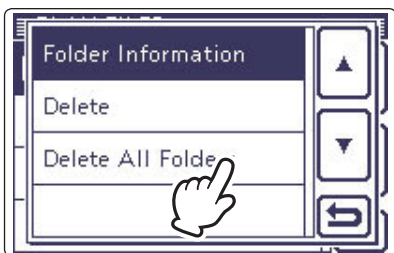

Touch “Voice Memo.”



Touch “QSO Recorder.”

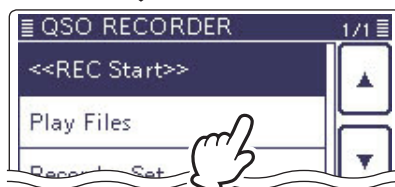

Touch “Play files.”

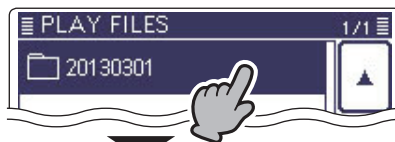

Touch the folder that you want to delete for 1 second



Touch “Delete.”



Touch “YES.”

## Continue to record even if no signals are received

In the default settings, the transceiver records audio only while receiving signals (the squelch is open). If you want to continue recording even if no signal is received, do the following steps.

- ① Push **SET**(C) to enter the Set mode.
- ② Touch the “RX REC Condition” item of the “Voice Memo” Set mode.  
(Voice Memo > QSO Recorder > Recorder Set > **RX REC Condition**)
  - If the specified item is not displayed, touch **[▲]** or **[▼]**(D) one or more times to select the page.
- ③ Touch “Always” to continuously record even if no signal is received.
  - Always: Recording continues, even if no signals are received.
  - Squelch Auto: The transceiver records audio only while receiving signals (the squelch opens).
- ④ Push **SET**(C) to exit the Set mode.

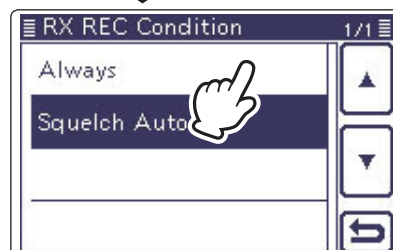
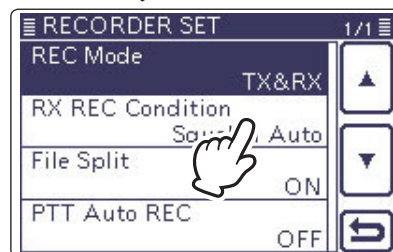
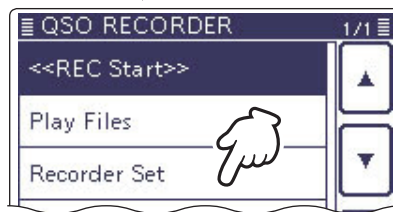
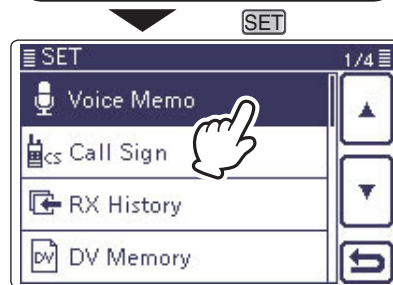
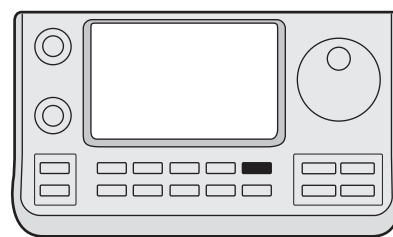
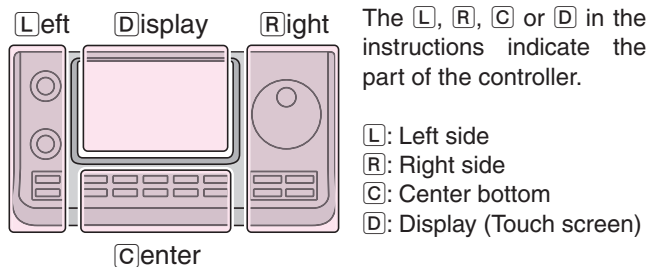

## Record the transmit and receive audio into the same file

The transceiver can record the transmit and receive audio into the same file.

- ① Push **SET**(C) to enter the Set mode.
- ② Touch the "File Split" item of the "Voice Memo" Set mode.  
(Voice Memo > QSO Recorder > Recorder Set > **File Split**)
  - If the specified item is not displayed, touch **[▲]** or **[▼]**(D) one or more times to select the page.
- ③ Touch "OFF."
  - OFF : The transceiver records the transmit and receive audio into the same file.
  - ON : The transceiver records the transmit and receive audio into each file.  
The transceiver makes separate new files for transmit and receive audio. (Default setting)
    - When you set the RX REC Condition item to "Squelch Auto," the transceiver records audio to the new file when the squelch either opens or closes.  
(Voice Memo > QSO Recorder > Recorder set > **RX REC Condition**)
- ④ Push **SET**(C) to exit the Set mode.

**NOTE:** Even if you set the "File Split" item to OFF, when the recording file's content becomes 2 GB, the transceiver continues to record, but to a new file.

### About the VOICE PLAYER screen when recording into the same file

The VOICE PLAYER screen shows information that is recorded first.

When the receive audio was recorded first, the transmit audio information is not displayed on the screen.

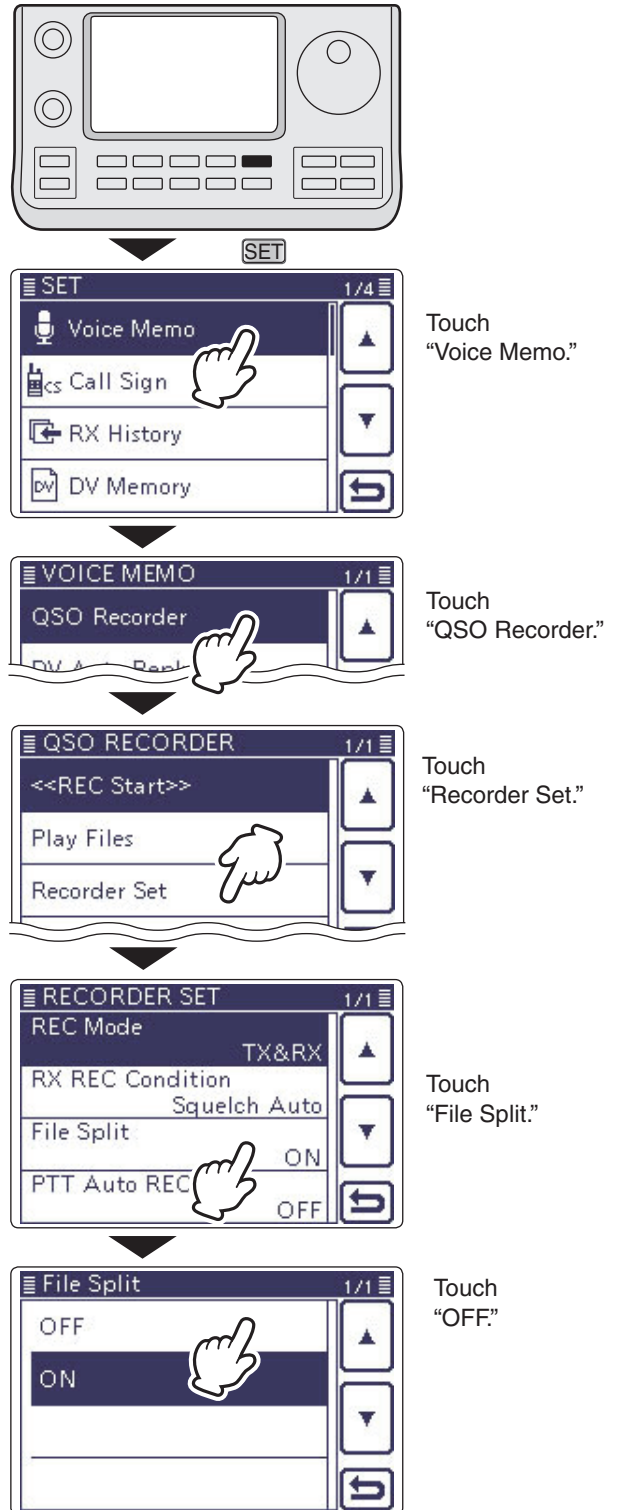

## Start to record when the [PTT] switch is pushed

The transceiver starts to record the transmitted audio when the [PTT] switch is pushed.

After transmitting, when the transceiver receives a signal in a given amount of time, it also records the received audio. Therefore, you can record all communication audio using this function.

- ① Push **SET**(C) to enter the Set mode.
- ② Touch the "PTT Auto REC" item of the "Voice Memo" Set mode.  
(Voice Memo > QSO Recorder > Recorder Set > **PTT Auto REC**)
  - If the specified item is not displayed, touch [▲] or [▼](D) one or more times to select the page.
- ③ Touch "ON."  
 • OFF : The transceiver does not start to record when the [PTT] switch is pushed.  
 • ON : The transceiver starts to record when the [PTT] switch is pushed.
- ④ Push **SET**(C) to exit the Set mode.

**NOTE: When you set PTT AUTO REC to ON, see the notes below.**

- The transceiver also starts to record audio when the optional microphone's [PTT] switch is pushed, transmitting using the **VOX** function or the **CI-V** remote controller.
- All transmit audio is recorded.  
(When "RX Only" is set in the "REC Mode" item, transmit audio is not recorded)
- When the transceiver receives a signal less than 10 seconds after transmitting, the transceiver also records the receive audio.
- In addition, when the transceiver receives a signal, and then receives other signals less than 10 seconds later, it records all signals audio.

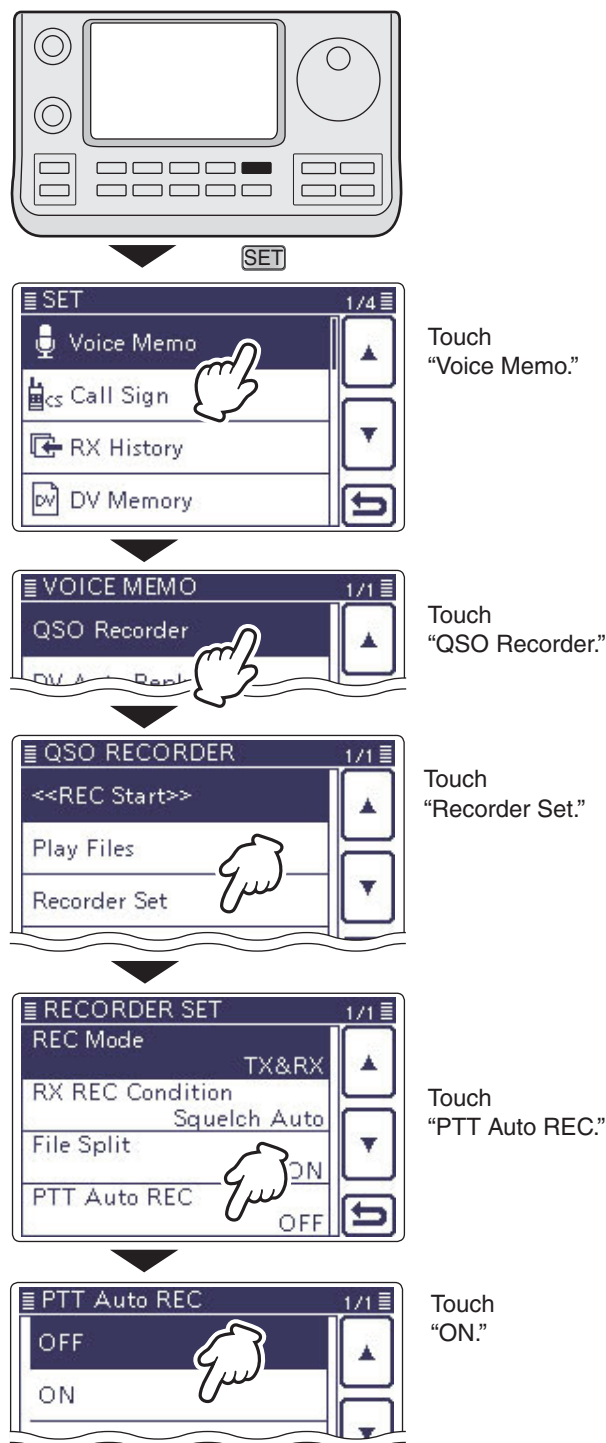
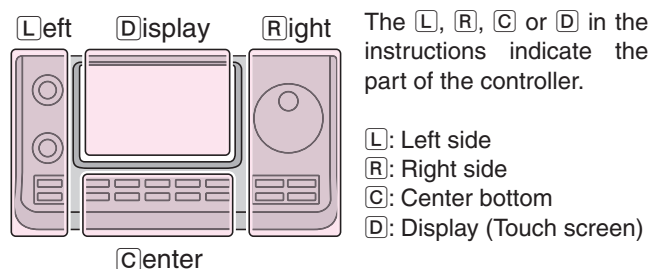



## Viewing the folder information

The transceiver can display the folder's name, number of the files in the folder, total capacity of the files and date.

- ① Push **SET**(**C**) to enter the Set mode.
- ② Touch the "Play Files" item of the "Voice Memo" Set mode.  
(Voice Memo > QSO Recorder > **Play Files**)
  - If the specified item is not displayed, touch [**▲**] or [**▼**](**D**) one or more times to select the page.
  - The folder list is displayed. (The folders are automatically made when recording starts.)
  - The folder name is formatted yyyyymmdd (y: year, m: month, d: day.)
- ③ Touch the folder that contains the file you want to view for 1 second.
- ④ Touch the "Folder Information" item.
- ⑤ Touch [**↵**](**C**) to cancel the information screen.
  - Touching **SET**(**C**) or **QUICK**(**C**) also cancels.
- ⑥ Push **SET**(**C**) to exit the Set mode.

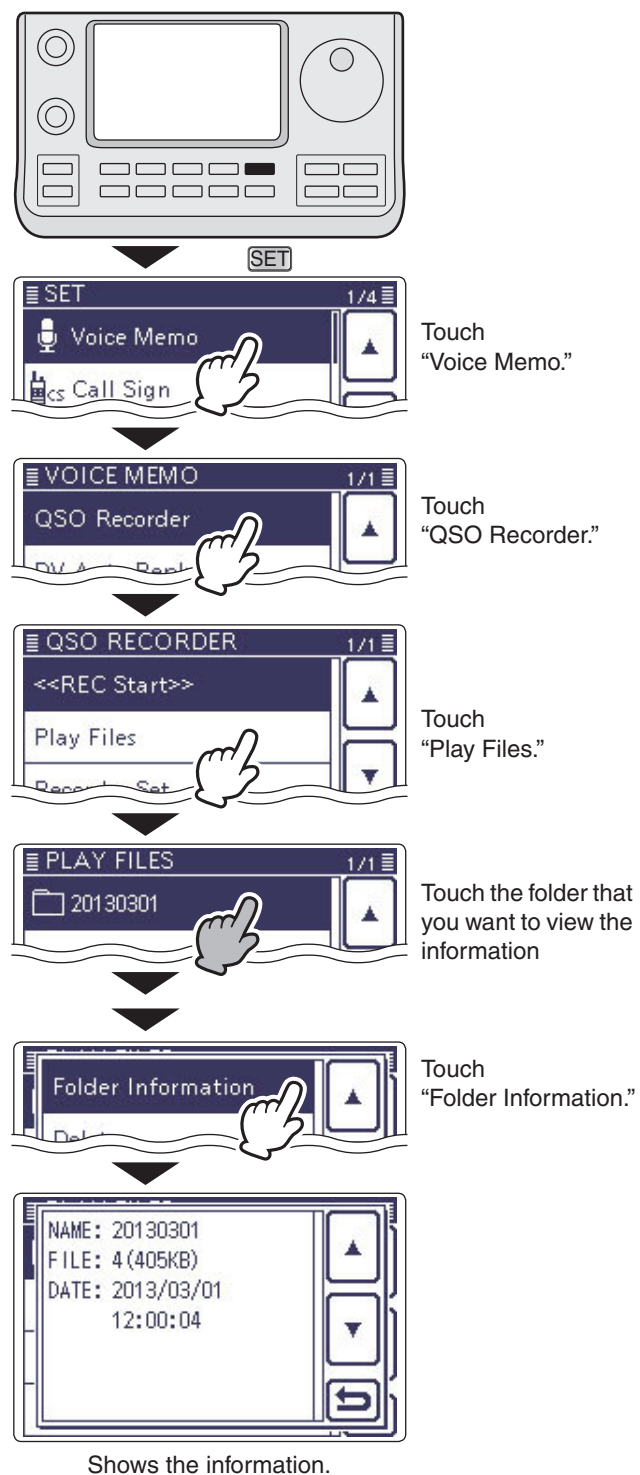
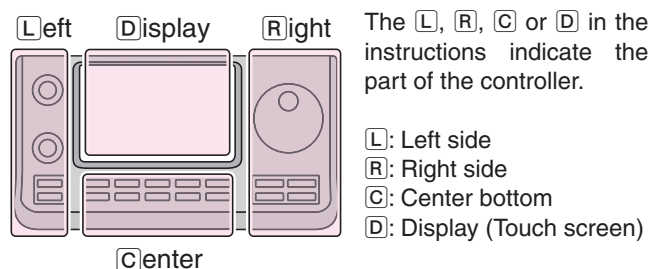



## Viewing the file information

The transceiver can display the recorded file's frequency, mode, date, and so on.

- ① Push **SET**(**C**) to enter the Set mode.
- ② Touch the "Play Files" item of the "Voice Memo" Set mode.  
(Voice Memo > QSO Recorder > **Play Files**)
  - If the specified item is not displayed, touch **[▲]** or **[▼]**(**D**) one or more times to select the page.
  - The folder list is displayed. (The folders are automatically made when recording starts.)
  - The folder name is formatted yyyyymmdd (y: year, m: month, d: day.)
- ③ Touch the folder that contains the file you want to view.
  - The file list is displayed.
  - The file name is formatted yyyy/mm/dd hh:mm:ss (y: year, m: month, d: day, hh: hour, mm: minute, ss: second.)
- ④ Touch the file that you want to view the information for 1 second.
- ⑤ Touch the "File Information" item.
- ⑥ Touch **[↵]**(**C**) to cancel the information screen.
  - Touching **SET**(**C**) or **QUICK**(**C**) also cancels.
- ⑦ Push **SET**(**C**) to exit the Set mode.

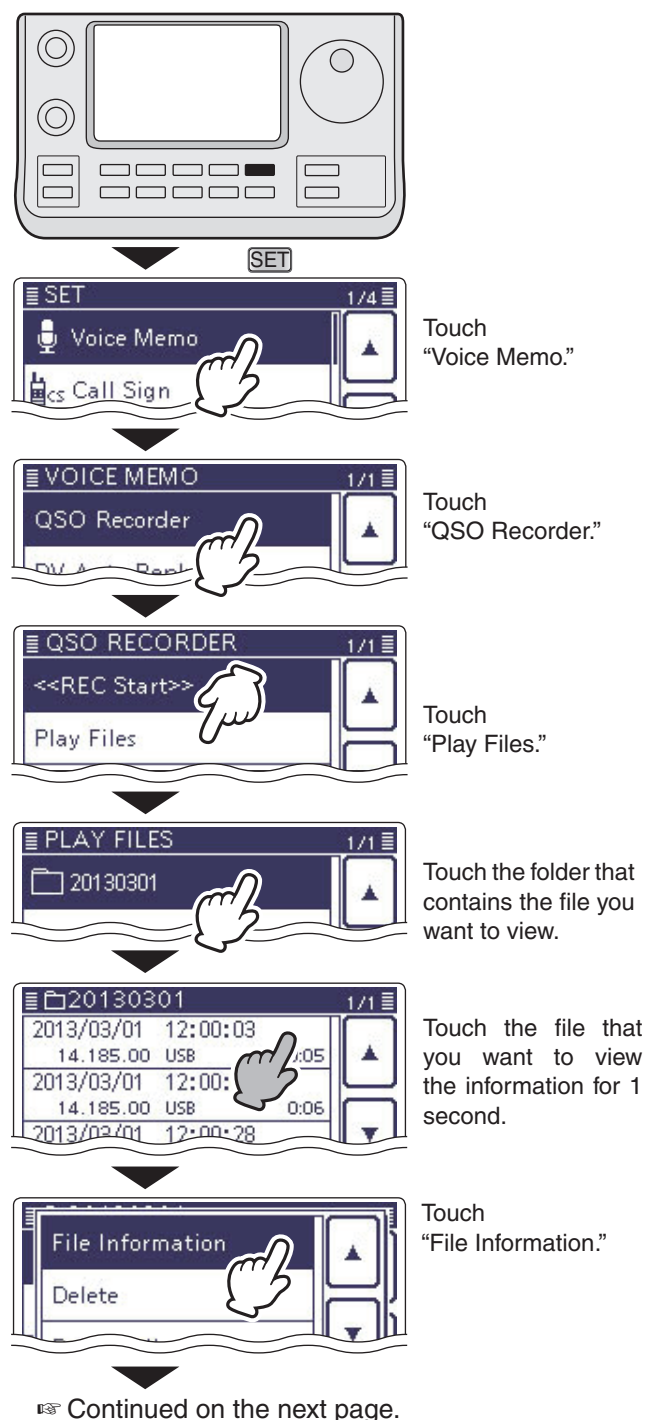
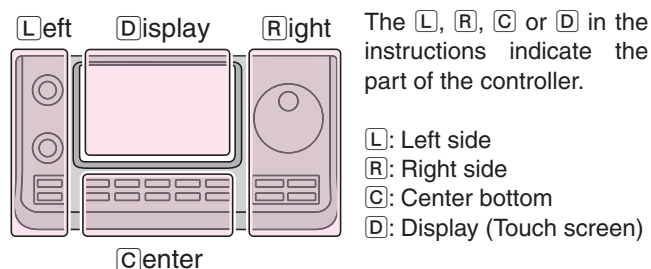

Viewing the file information (Continued)

Example of file information screens (The display items differ, depending on the recording contents.)

• Transmit Information screen

(Your own position) (Transmitting in the DR mode)

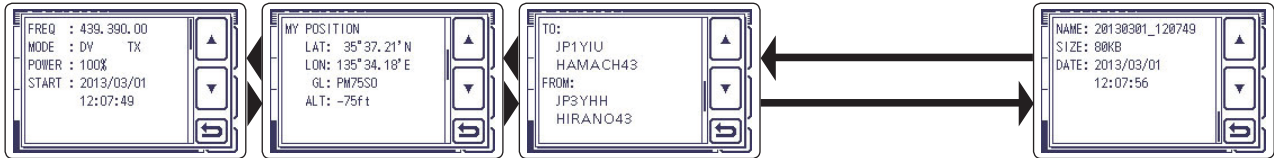

• Receive Information screen

(Your own position) (Receiving in the DR mode) (Destination position)

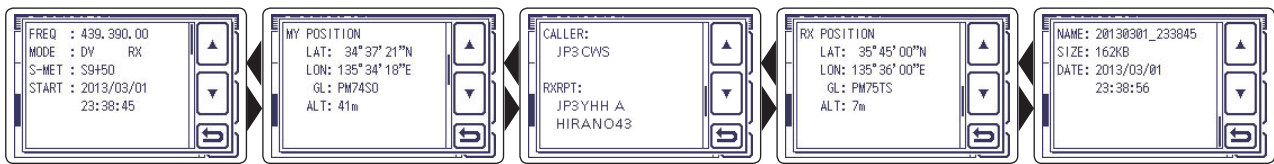

## Viewing the SD card's free space and recordable time

- ① Push **SET**(**C**) to enter the Set mode.
- ② Touch the "SD Card" item.
  - If the specified item is not displayed, touch [**▲**] or [**▼**](**D**) one or more times to select the page.
- ③ Touch the "SD Card Info" item.
  - The information screen appears.
- ④ Touch [**>**](**C**) to cancel the information screen.
  - Touching **SET**(**C**) or **QUICK**(**C**) also cancels.
- ⑤ Push **SET**(**C**) to exit the Set mode.

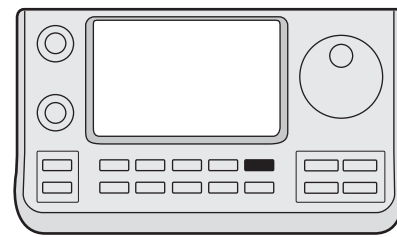
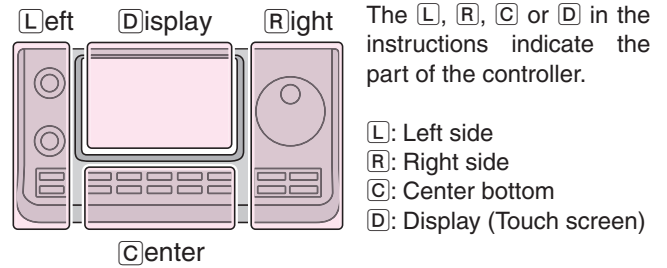

**SET**

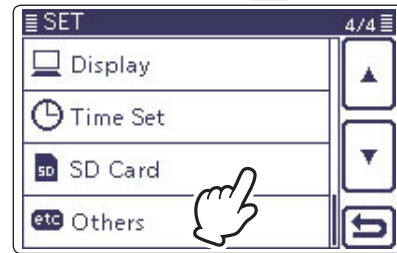

Touch "SD Card."

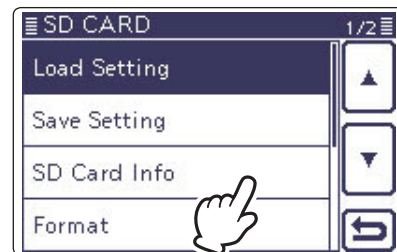

Touch "SD Card Info."



Shows the information screen.

## Playing back the voice memory data on a PC

You can also playback the voice memory data on a PC.

However, the recorded information (frequency, date, and so on) are not displayed.

• Microsoft® Windows® 7 is used for the description.

Example: Connect a memory card reader (3rd party product) to the PC, and insert the SD card into the reader. Then playing back the voice memory data in the card.

• When you copy the voice memory data from the SD card to the PC's hard disk drive, you also operate the same as following steps for playing back data.

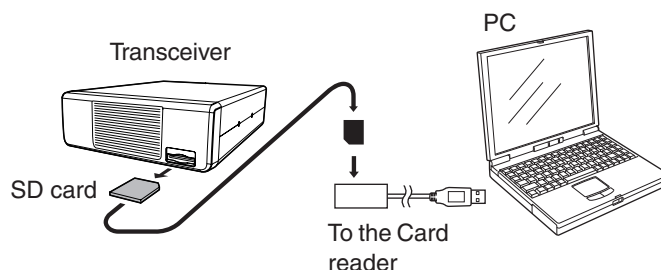

- ① Connect the memory card reader to the PC, and then insert the SD card into the reader.
  - If your PC has an SD card drive, insert the card into the drive.
- ② When the SD card is inserted in the SD card drive of the PC or the SD card reader, the screen appears, as shown to the right.
  - The [IC-7100] folder appears.
- ③ Double-click the [IC-7100] folder.

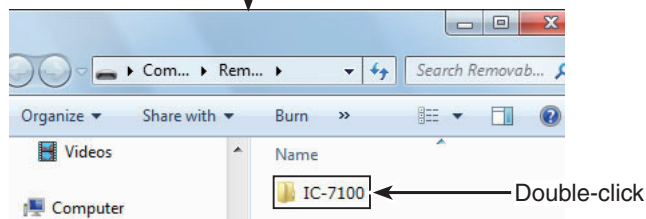
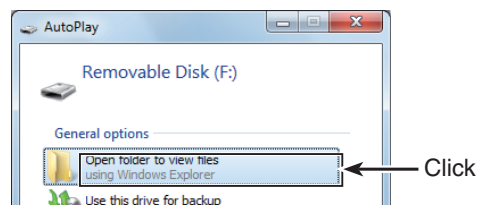

- ④ Double-click the [Voice] folder.

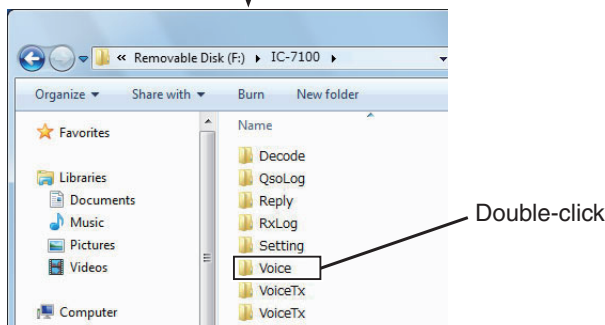

- ⑤ Double-click the folder in which the file you want to playback is stored. (Example: 20130301 folder)
- ⑥ To playback the file, double-click it. (Example: 20130301\_184451.wav)

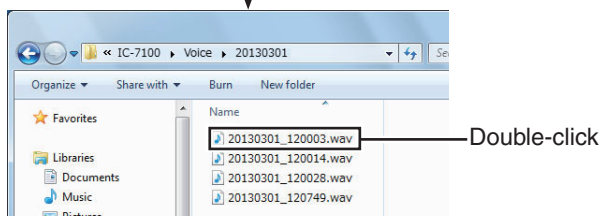
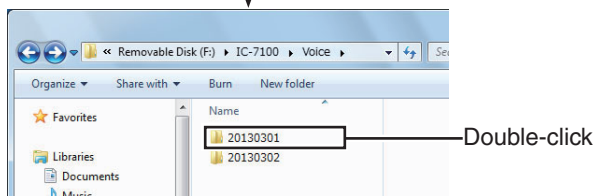

**NOTE:**

- The operations while playing back may differ, depending on the software. Therefore, refer to the software's instruction manual for details.
- When the file does not playback, even if you double-click the file, download appropriate software like Windows Media® Player.

## Section 15 VOICE TX FUNCTION

---

Recording the voice audio.....	15-2
Playing back the recorded voice audio .....	15-3
Programming a memory name.....	15-4
Transmitting the recorded voice audio.....	15-6
◇ Adjusting the TX volume level .....	15-7
Voice TX Set mode.....	15-8

## Recording the voice audio

The Voice TX function transmits the recorded audio on an SD card once, or repeatedly, for up to 10 minutes at the specified interval.

Up to 4 memories are available for repeated CQ and exchange transmissions in contests, as well as when making repeated calls to **DX'peditions**.

The recorded audio can be transmitted in the SSB, AM (HF/50 MHz only), FM or DV mode.

The Voice TX function can be assigned to a key on the optional HM-151 REMOTE CONTROL MIC or an external keypad. (p. 17-22)

**NOTE:** Be sure to insert an SD card into the transceiver before recording a voice audio.

- ① Push **MENU**(C) one or more times to select the "M-2" (Menu 2) screen.
  - In the DR mode, select the "D1" screen.
- ② Touch **[VOICE]**(D) to select the Voice TX mode.
  - The "VOICE TX" screen is displayed.
- ③ Push **MENU**(C) to display the "VOICE" screen.
- ④ Touch **[REC]**(D) to display the "VOICE TX RECORD" screen.
- ⑤ Touch the desired memory, [T1] through [T4].
  - The "VOICE TX RECORD (T1)" screen is displayed, when [T1] memory is selected.
- ⑥ Touch **[●]**(D) to start recording.
  - Touch **[■]**(D) to stop recording.
  - The maximum record time is 90 seconds.
  - Hold the microphone 5 to 10 cm (2 to 4 inches) from your mouth, then speak at a normal voice level.
  - Touch **[MIC GAIN]**(D) to display the "MIC GAIN" screen.
  - If you record again on the same channel, the current contents will be overwritten.
- ⑦ Touch **[>]**(D) to return to the "VOICE TX RECORD" screen.

### Information

To delete the recorded audio, touch the center of the "VOICE TX RECORD (T1)" through "VOICE TX RECORD (T4)" screen for 1 second, or push **QUICK**(C), and then touch "Clear."

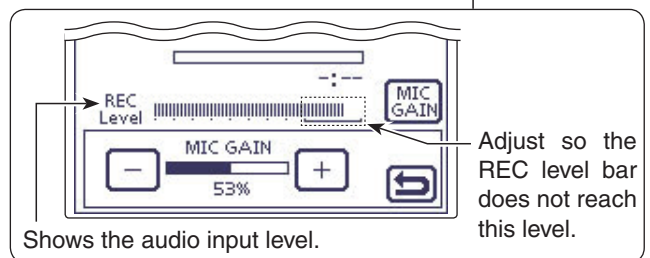
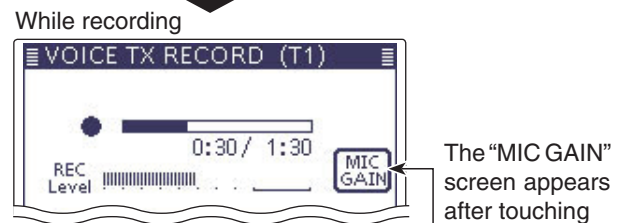
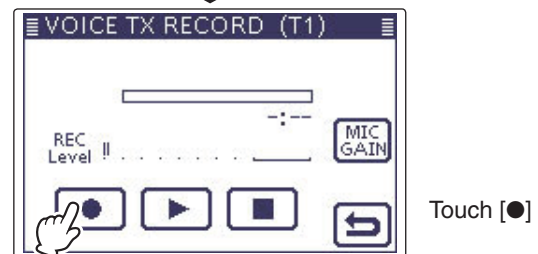
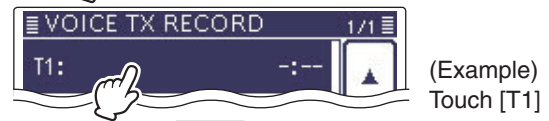
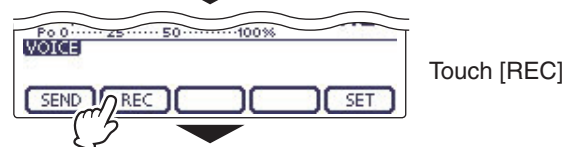
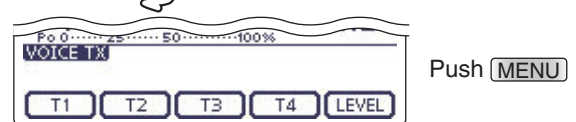
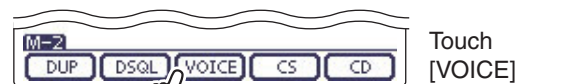
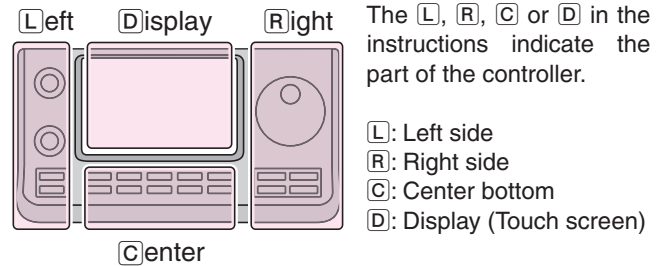
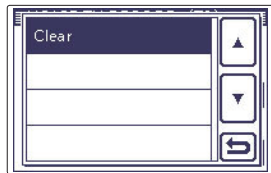

## Playing back the recorded voice audio

The recorded voice audio for the Voice TX function can be played back.

- ① Push **MENU**(**C**) one or more times to select the “M-2” (Menu 2) screen.
  - In the DR mode, select the “D1” screen.
- ② Touch **[VOICE]**(**D**) to select the Voice TX mode.
  - The “VOICE TX” screen is displayed.
- ③ Push **MENU**(**C**) to display the “VOICE” screen.
- ④ Touch **[REC]**(**D**) to display the “VOICE TX RECORD” screen.
- ⑤ Touch the desired memory, [T1] through [T4].
  - The “VOICE TX RECORD (T1)” screen is displayed, when [T1] memory is selected.
- ⑥ Touch **[▶]**(**D**) to start the playback.
  - Touch **[■]**(**D**) to stop the playback.
- ⑦ Touch **[↶]**(**D**) to return to the “VOICE TX RECORD” screen.

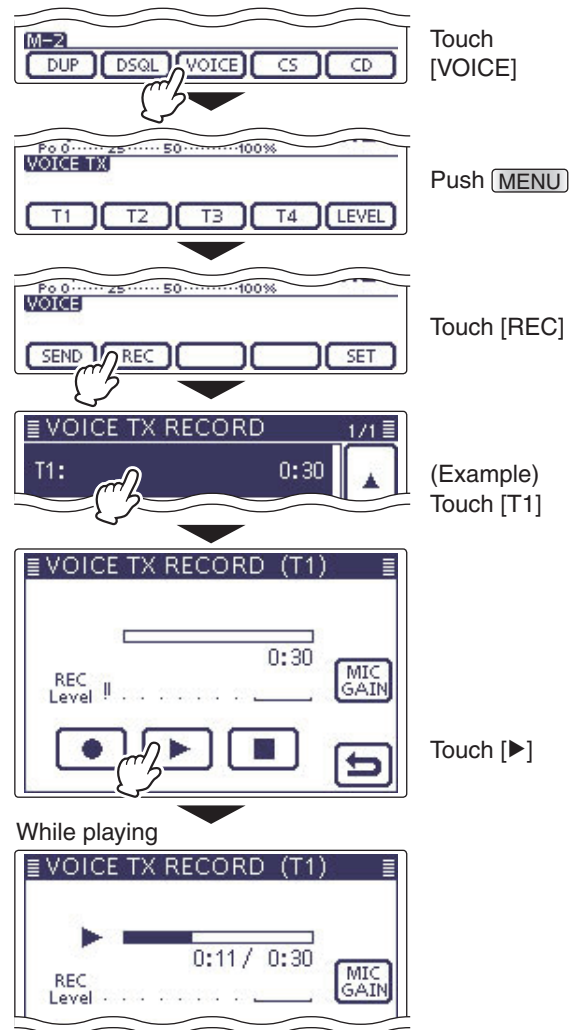
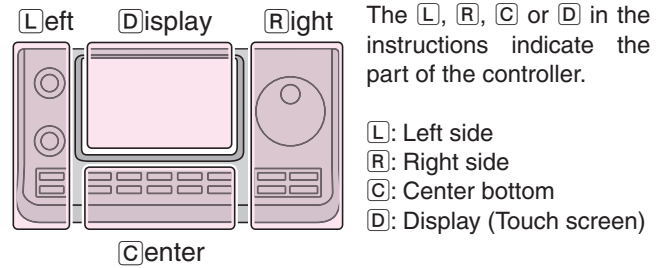



## Programming a memory name

Each Voice TX memory, [T1] through [T4], can be programmed with an alphanumeric name of up to 16 characters.

**[EXAMPLE]:** Programming the memory name “Contest” in [T1].

- ① Push **MENU**(C) one or more times to select the “M-2” (Menu 2) screen.
  - In the DR mode, select the “D1” screen.
- ② Touch **VOICE**(D) to select the Voice TX mode.
  - “VOICE TX” screen is displayed.
- ③ Push **MENU**(C) to display the “VOICE” screen.
- ④ Touch **REC**(D) to display the “VOICE TX RECORD” screen.
- ⑤ Touch the desired memory, “T1:” through “T4:,” for 1 second to program.
- ⑥ Touch “Edit Name” to display the “VOICE TX RECORD (T1)” screen (Voice TX name edit screen).
  - A cursor appears and blinks.
- ⑦ Touch the desired block one or more times to select the desired character or symbol.

Selectable characters and symbols
A to Z, a to z, 0 to 9, ! # \$ % & \ ? ' ' ' ^
+ - * / . , ; = < > ( ) [ ] { }   _ ' @ (space)

- Touch “AB↔12” to toggle between the Alphabet input and Number input mode.
- Touch **CLR**(D) to delete the selected character, symbol or number.
- Touch **[AB]**(D) to open the input mode selection window.
- Touch “\_” to input a space.

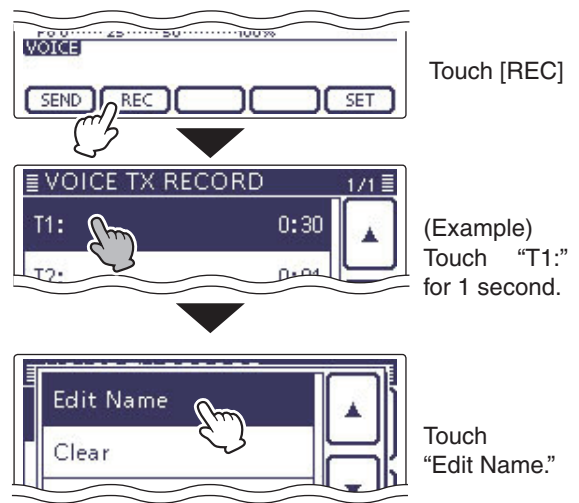
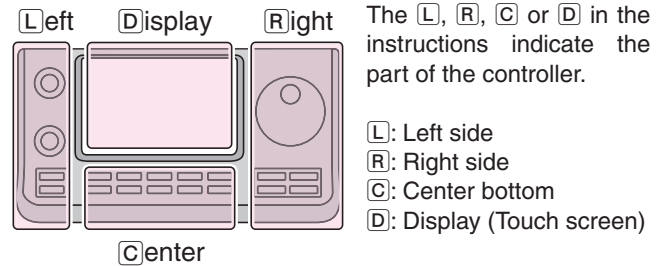

### Memory name edit screen

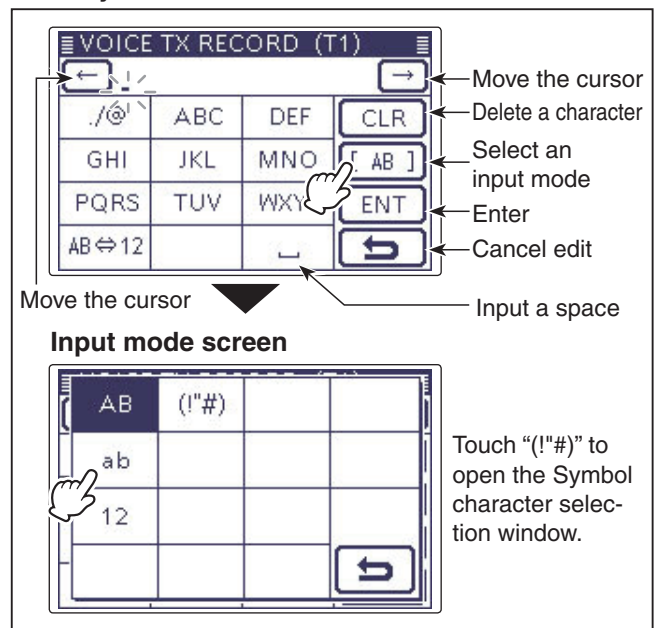

Continued on the next page.

## Programming a memory name (Continued)

- ⑧ Touch [←](D) to move the cursor backwards, or touch [→](D) to move the cursor forwards.
- ⑨ Repeat steps ⑦ and ⑧ to program up to 16 characters memory name, and then touch [ENT](D) to save the name, and return to the “VOICE TX RECORD” screen.
- ⑩ Touch [↵](D) to return to the “VOICE TX RECORD” screen.

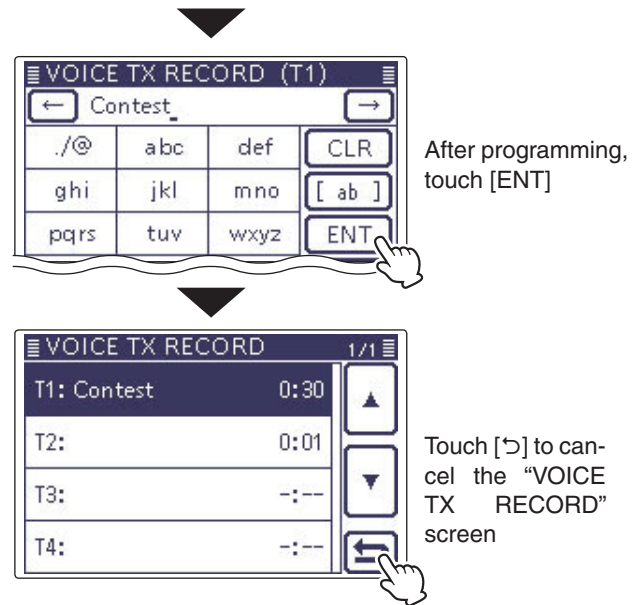

## Transmitting the recorded voice audio

- ① Push **MENU**(C) one or more times to select the “M-2” (Menu 2) screen.
  - In the DR mode, select the “D1” screen.
- ② Touch **[VOICE]**(D) to select the Voice TX mode.
  - “VOICE TX” screen is displayed.
- ③ Push **MENU**(C) to display the “VOICE” screen.
- ④ <<**Single TX**>>

Touch the desired memory, [T1] through [T4] to transmit the recorded voice audio once.

### <<Repeat TX>>

Touch the desired memory, [T1] through [T4] for 1 second to repeatedly transmit the recorded voice audio for up to 10 minutes at the interval specified in “Repeat Time.”

- Even if 10 minutes pass while transmitting, the voice audio is completely transmitted.
- During the Voice TX waiting, the selected memory blinks.
- One of the following steps will cancel the transmission.
  - Touch the memory again.
  - Turn OFF the power, then turn it ON again.
  - Touch another memory (except for [LEVEL]).
  - Push **MENU**(C), **XFC**(R) or **SET**(C).
  - Push **QUICK**(C).

The repeat transmission is cancelled. But while transmitting, the voice audio is completely transmitted.

- Once the Repeat TX is made, the transceiver pauses until the end of the “Repeat Time,” then transmits again. After the second transmission, the Repeat TX continues pausing, if receiving a signal. But if the squelch is manually opened, the voice audio is repeatedly transmitted, according to the repeat time setting.

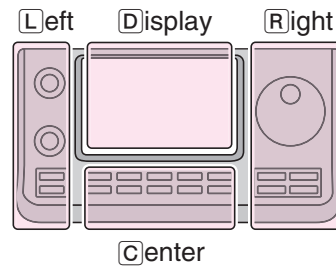

The L, R, C or D in the instructions indicate the part of the controller.

- L: Left side
- R: Right side
- C: Center bottom
- D: Display (Touch screen)



Touch **[VOICE]**

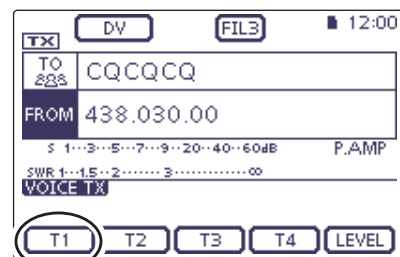

Touch the desired memory,

Single TX

Repeat TX

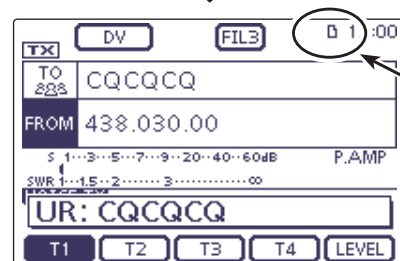

Blinks while transmitting

### • Voice TX Waiting screen for <<Repeat TX>>

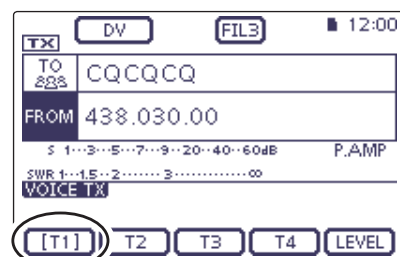

Blinks

Transmitting the recorded voice audio (Continued)

◇ **Adjusting the TX volume level**

- ① Push **MENU**(C) one or more times to select the "M-2" (Menu 2) screen.
  - In the DR mode, select the "D1" screen.
- ② Touch **[VOICE]**(D) to select the Voice TX mode.
  - "VOICE TX" screen is displayed.
- ③ Touch **[LEVEL]**(D) to display the "TX LEVEL" screen.
- ④ Rotate the Dial to adjust the transmit voice level.
  - Too high of a voice level may cause interference.
  - Touch **[DEF]**(D) for 1 second to reset to the default setting (50 %), if desired.
- ⑤ Touch **[LEVEL]**(D) to save, and exit the "TX LEVEL" screen.

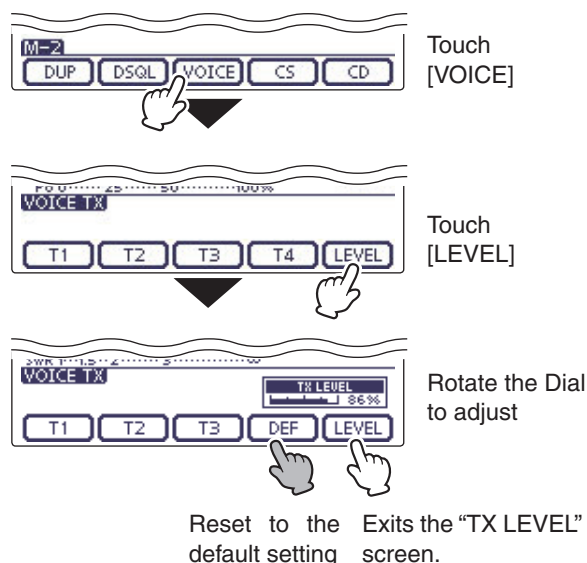

**Hiding the Voice TX memory name**

The voice TX memory name can be hidden on the "VOICE TX" screen.

- ① Push **SET**(C) to enter the Set mode.
- ② Touch the "VOICE TX Name Display" item of the "Display" Set mode.
  - (Display > **VOICE TX Name Display**)
  - If the specified item is not displayed, touch **[▲]** or **[▼]**(D) one or more times to select the page.
- ③ Touch "OFF."
- ④ Push **SET**(C) to exit the Set mode.

**When "ON" is selected.**

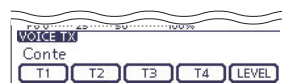

The voice TX memory name is displayed.

**When "OFF" is selected.**

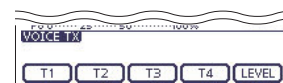

The voice TX memory name is not displayed.

**Setting the VOICE first menu screen**

Select the first appearance screen after touching **[VOICE]**(D).

- ① Push **SET**(C) to enter the Set mode.
- ② Touch the "VOICE 1st menu" item of the "Function" Set mode.
  - (Function > **VOICE 1st menu**)
  - If the specified item is not displayed, touch **[▲]** or **[▼]**(D) one or more times to select the page.
- ③ Touch the desired option.
  - VOICE-Root: Displays the "VOICE" screen first.
  - VOICE-TX: Displays the "VOICE TX" screen first.
- ④ Push **SET**(C) to exit the Set mode.

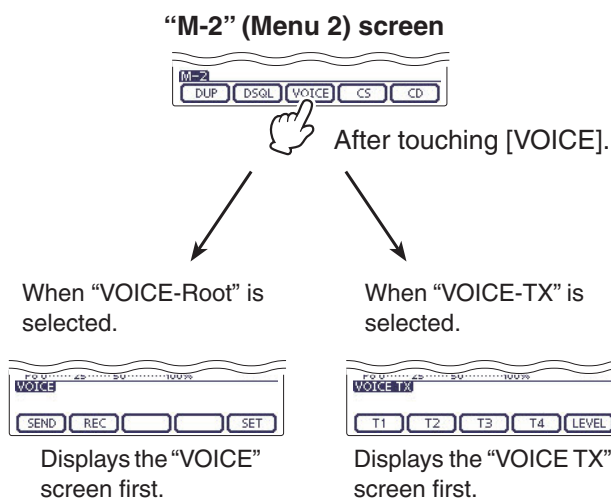

## Voice TX Set mode

- ① Push **[MENU]**(C) one or more times to select the “M-2” (Menu 2) screen.
  - In the DR mode, select the “D1” screen.
- ② Touch **[VOICE]**(D) to select the Voice TX mode.
  - “VOICE TX” screen is displayed.
- ③ Push **[MENU]**(C) to display the “VOICE” screen.
- ④ Touch **[SET]**(D) to display the “VOICE TX SET” screen.
- ⑤ Touch a desired item.
- ⑥ Touch a desired option.
  - See the descriptions below for details of items and options.
  - Push **[QUICK]**(C), and then touch “Default” to reset to the default setting, if desired.
- ⑦ Push **[MENU]**(C) to return to the “VOICE” screen.

### Repeat Time (Default: 5sec)

Set the repeat interval to between 1 and 15 seconds (in 1 second steps) for the voice repeat transmission. The transceiver repeatedly transmits the recorded voice audio at this interval.

### Auto Monitor (Default: ON)

Turn the TX Monitor function ON or OFF.

- OFF: The TX voice audio is not heard from the speaker.
- ON: The TX voice audio is heard from the speaker.

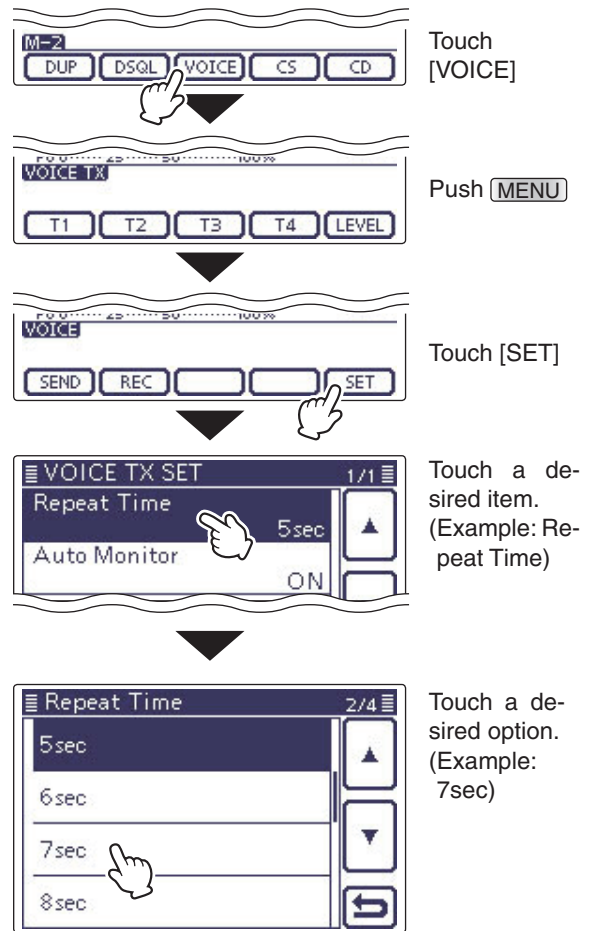

# Section 16 ANTENNA TUNER OPERATION

---

<b>Connecting the antenna tuner.....</b>	<b>16-2</b>
◇ Connecting an AH-4.....	16-2
◇ Connecting an AT-180 .....	16-2
◇ Connector information for the AT-180 ACC(2) socket.....	16-3
◇ Specifications for the AH-4.....	16-3
◇ Specifications for the AT-180 .....	16-3
<b>Operating the AH-4.....</b>	<b>16-4</b>
◇ Before operating.....	16-4
◇ Operating.....	16-4
◇ PTT tune function .....	16-4
<b>Operating the AT-180.....</b>	<b>16-5</b>
◇ Before operating.....	16-5
◇ Operating.....	16-6
<b>Setting the AT-180 internal switches.....</b>	<b>16-7</b>
◇ Automatic tuner start (HF bands only) .....	16-7
◇ PTT tune function .....	16-7

## Connecting the antenna tuner

The AH-4 and AT-180 AUTOMATIC ANTENNA TUNER automatically matches the IC-7100 to the connected antenna.

**NOTE:** Before connecting, be sure to turn OFF the transceiver's power.

### ◇ Connecting an AH-4

The optional AH-4 matches the IC-7100 to a long wire antenna more than 7 m/23 ft long (3.5 MHz and above).

- See page 16-4 for operation.
- See the AH-4 instruction manual installation and antenna connection details.

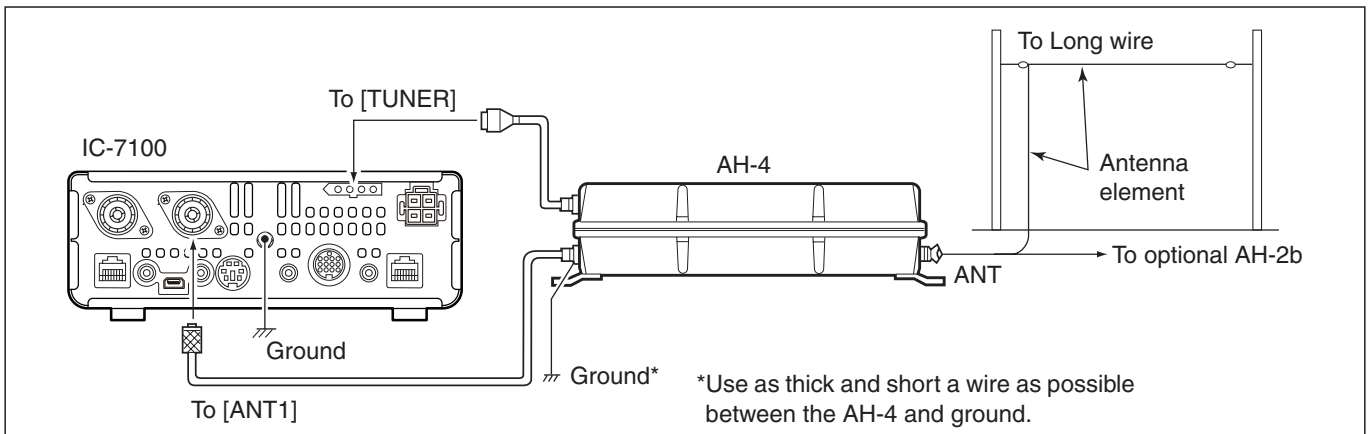

### ◇ Connecting an AT-180

The optional AT-180 matches the IC-7100 to both HF and 50 MHz antenna, and automatically tunes the antenna (impedance range: 16.7 to 150 Ω) during transmission when the antenna SWR is less than 1:3 (HF band).

- See page 16-5 for operation.

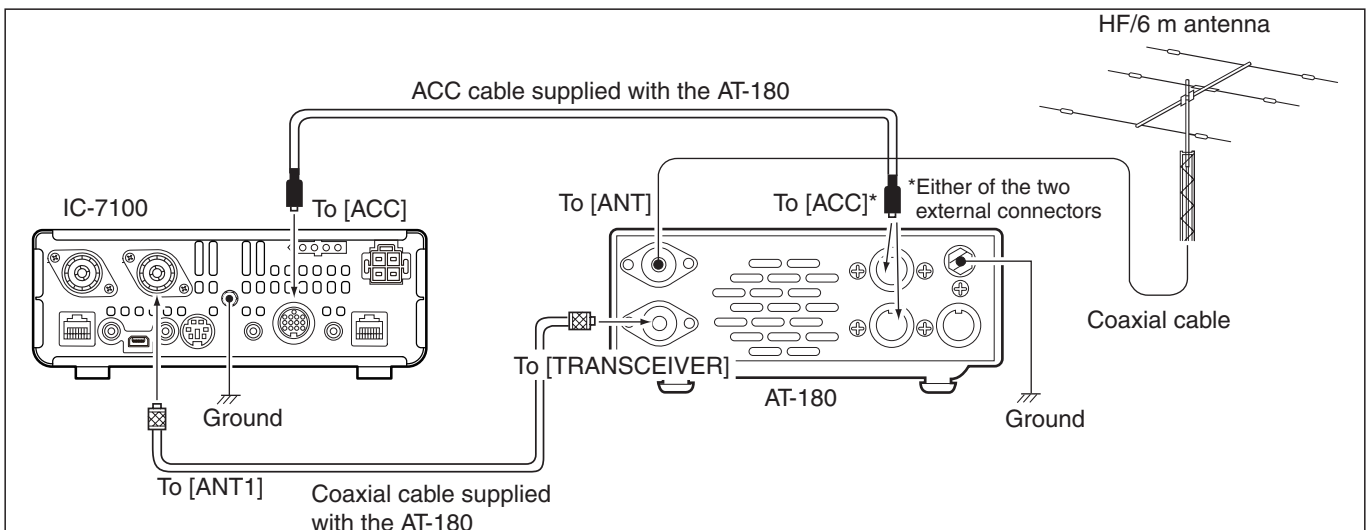



Connecting the antenna tuner (Continued)

◇ Connector information for the AT-180 ACC(2) socket

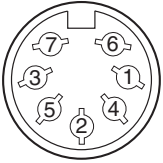
PIN LAYOUT	PIN NO./NAME	DESCRIPTION	SPECIFICATIONS
 <p>(Rear panel view)</p>	① 8 V	Regulated 8 V output when the <b>Band</b> Voltage modification is performed.	Same as ACC pin ①.
	② GND	Connects to ground.	–
	③ HSEND	Input/output pin. Goes to ground when transmitting When grounded, transmits.	Same as ACC pin ③.
	④ NC	No connection.	–
	⑤ ALC	<b>ALC</b> output voltage	Same as ACC pin ⑥.
	⑥ NC	No connection.	–
	⑦ 13.8 V	13.8 V output when power is ON	Same as ACC pin ⑧.

◇ Specifications for the AH-4

- Frequency coverage : 7–54 MHz (with an AH-2b)  
3.5–54 MHz (with more than 7 meters long wire)
- Input impedance : 50 Ω
- Maximum input power : 120 W
- Minimum tuning power : 10 W (5–15 W)
- Tuning accuracy : Less than SWR 2:1
- Power supply requirements : 13.8 V DC/1 A (supplied from the transceiver's ACC socket)
- Dimensions (mm/in) : 172(W) × 69.5(H) × 230(D)  
6.7 (W) × 2.7(H) × 9.0(D)
- Weight (Approximately) : 1.2 kg; 2.6 lb
- Supplied accessories : See the AH-4 instruction manual

◇ Specifications for the AT-180

- Frequency coverage : 1.8–54 MHz
- Input impedance : 50 Ω
- Maximum input power : 120 W
- Minimum tuning power : 8 W
- Matching impedance range : 16.7–150 Ω (HF band)  
20–125 Ω (50 MHz band)
- Tuning accuracy : Less than SWR 1.5:1
- Insertion loss : Less than 1.0 dB (after tuning)
- Power supply requirements : 13.8 V DC/1 A (supplied from the transceiver's ACC socket)
- Dimensions (mm/in) : 167(W) × 58.6(H) × 225(D)  
6.6(W) × 2.3(H) × 8.9(D)
- Weight (Approximately) : 2.3 kg; 5.1 lb
- Supplied accessories : ACC cable (DIN 13 pins)  
Coaxial cable (1 m),

## Operating the AH-4

### ◇ Before operating

**⚠ DANGER HIGH VOLTAGE!**

**NEVER** touch the antenna element while tuning or transmitting.

Always place it in a secure place.

**NEVER** operate the AH-4 without an antenna connected. The tuner and transceiver will be damaged.

**NEVER** operate the AH-4 when it is ungrounded.

Transmitting before tuning may damage the transceiver. Note that the AH-4 cannot tune when using a  $1/2\lambda$  long wire or on a multiple of that frequency.

### ◇ Operating

Tuning is required for each frequency. Be sure to retune the antenna before transmitting when you change the frequency—even slightly.

- ① Push **TUNER/CALL**(L) to turn ON the AH-4. The CW mode and 10 W output power are automatically selected, and the tuning starts.
  - The TX LED lights red.
  - “**TUNE**” blinks while tuning.
  - After changing the frequency, you should hold down **TUNER/CALL**(L) for 1 second to manually start tuning. In this case, the CW mode and 10 W output power are automatically selected, and the TX LED lights red.

**NOTE: DO NOT** change the frequency and operating mode while “**TUNE**” is blinking. It may take approximately 2 to 3 seconds (maximum of 15 seconds) to complete tuning.
- ② “**TUNE**” is still ON after the tuning is completed, and the previously selected operating mode and the output power are automatically selected.
  - When the connected wire cannot be tuned, “**TUNE**” goes out, the AH-4 is bypassed and the antenna wire is directly connected.

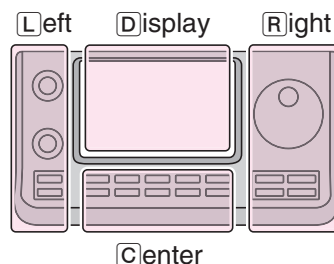

The L, R, C or D in the instructions indicate the part of the controller.

- L: Left side
- R: Right side
- C: Center bottom
- D: Display (Touch screen)

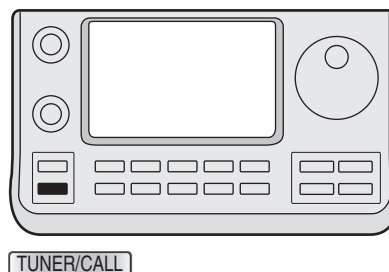

### ◇ PTT tune function

The AH-4 always tunes when [PTT] is pushed after the frequency is changed on an HF/50 MHz bands (more than 1%).

Turn ON this function in the “Function” Set mode.

(p. 17-20)

**SET**(C) > Function > Tuner > **PTT Start**

## Operating the AT-180

### ◇ Before operating

#### 1. About using antenna:

##### CAUTION:

- **NEVER** connect the antenna worth than 3:1 antenna. Even if the antenna tuner tune this antenna, it causes to damage the antenna tuner.
- **NEVER** transmit with the tuner ON if no antenna is connected. This will damage both the transceiver and antenna tuner.

#### 2. If the tuner cannot tune the antenna:

- Check the untuned antenna SWR.  
If its SWR is worth than 3:1, adjust the SWR.
- Check the transmit power.  
If the transmit power is less than 8 W, adjust the RF power on the Mic gain/RF power adjustment display.

- 1 Push [MIC/RF PWR](C) to open the MIC gain/RF power adjustment display.

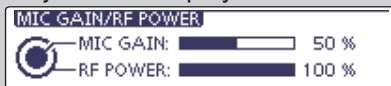

- 2 Rotate [BANK](L) to adjust the RF power.
- 3 Push [MENU](C) to close the display.

- Check the power source voltage/current capacity.
- If the tuner still cannot reduce the SWR to less than 1.5:1 after checking the above, perform the following:
  - Try manual tuning one or more times.
  - Adjust the antenna feedline length. (This is effective for higher frequencies in some cases.)
  - Even if manual tuning does not match the antenna and the tuner turns OFF the first time, it may match the antenna the second time.

- Check the untuned antenna SWR. (Less than 3:1 for the HF bands; Less than 2.5:1 for the 50 MHz band)
- Before start tuning, monitor the operating frequency to make sure transmitting won't cause interference to other stations on the same frequency.

- Tuning a narrow bandwidth antenna  
Some antennas, especially for the low bands, have a narrow bandwidth. These antennas may not be tuned beyond the edge of their operating bandwidth, therefore, manually tune such an antenna as follows:

**[Example]:** Suppose you have an antenna which has an SWR of 1.5:1 at 3.55 MHz and an SWR of 3:1 at 3.8 MHz.

- 1 Select 3.55 MHz and hold down [TUNER/CALL](L) for 1 second to start manual tuning.
- 2 Select 3.80 MHz and hold down [TUNER/CALL](L) for 1 second to start manual tuning.

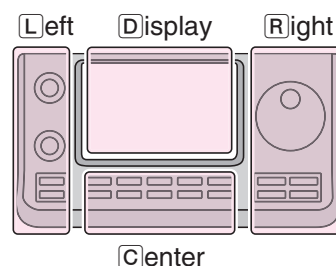

The L, R, C or D in the instructions indicate the part of the controller.

- L: Left side
- R: Right side
- C: Center bottom
- D: Display (Touch screen)

Operating the AT-180 (Continued)

◇ **Operating**

The AT-180 AUTOMATIC ANTENNA TUNER automatically matches to your antenna. Once the tuner matches the antenna, the variable capacitor settings are memorized as a preset point for each frequency range (100 kHz steps). Therefore, when you change the frequency range, the variable capacitors are automatically preset to the memorized point.

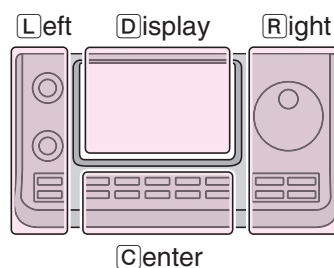

The [L], [R], [C] or [D] in the instructions indicate the part of the controller.

- [L]: Left side
- [R]: Right side
- [C]: Center bottom
- [D]: Display (Touch screen)

NOTE:

- The AT-180 can match both the HF and 50 MHz bands. However, operation is different for the bands.
- When connecting the AT-180, the transceiver's output power should be more than 8 W. Otherwise, the AT-180 may not tune correctly. The AT-180's minimum operating input power is 8 W.

- ① Check the transceiver's output power is set to 8 W.
- ② Push [TUNER/CALL]([L]) to turn ON the AT-180.
  - "TUNE" appears.

**For the HF band:**

The antenna is automatically tuned during transmit if the antenna SWR is higher than 1.5:1.

**For the 50 MHz band:**

"TUNE" blinks if the antenna SWR is higher than 1.5:1, regardless of the internal switch position described on the page 16-7. In this case, do the step ③ to manually tune the antenna.

- If you continue to transmit without retuning, "TUNE" goes out after approximately 10 seconds, the AT-180 is bypassed and the antenna is directly connected.

- ③ Push [TUNER/CALL]([L]) for 1 second to start manual tuning.
  - While tuning, the transceiver transmits in the CW mode and "TUNE" blinks.

NOTE: DO NOT change the frequency and operating mode while "TUNE" is blinking.

- ④ "TUNE" is still ON after the tuning is completed, and the previously selected operating mode is automatically selected.
  - When the connected wire cannot be tuned, "TUNE" goes out, the AT-180 is bypassed and the antenna is directly connected.

Once the tuner matches the antenna, the variable capacitors are automatically preset to the memorized point when you change the frequency range in 100 kHz steps.

- While presetting, "TUNE" blinks.

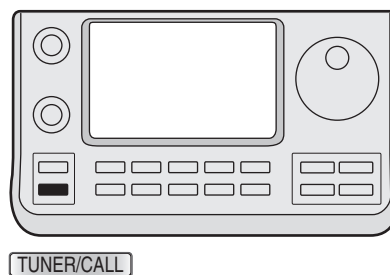

## Setting the AT-180 internal switches

The optional AT-180 has 3 operating configurations for HF **band** operation. Select a suitable configurations for your antenna system.

- ① Remove the top cover of the AT-180.
- ② Set the tuner switches to the desired positions according to the table below.

SW	Position	Operation
S1	A (default)	The tuner operating mode is set by S2 described below.
	B	<b>THROUGH INHIBIT</b> The tuner tunes the antenna even when the antenna has poor SWR (up to VSWR 3:1 after tuning). In this case, manual tuning is necessary each time you change the frequency although the tuner automatically starts tuning when the VSWR is higher than 3:1. This setting is called "through inhibit," however, the tuner is set to "through" if the VSWR is higher than 3:1 after tuning.
S2	C	<b>TUNER SENSITIVE SETTING</b> The tuner tunes each time you transmit (except SSB mode). Therefore, the lowest SWR is obtained at any given time. For SSB mode, the same SETTING as the "D" position.
	D (default)	<b>NORMAL</b> The tuner tunes when the SWR is higher than 1.5:1. Therefore, the tuner activates only when tuning is necessary.

• AT-180 inside top cover

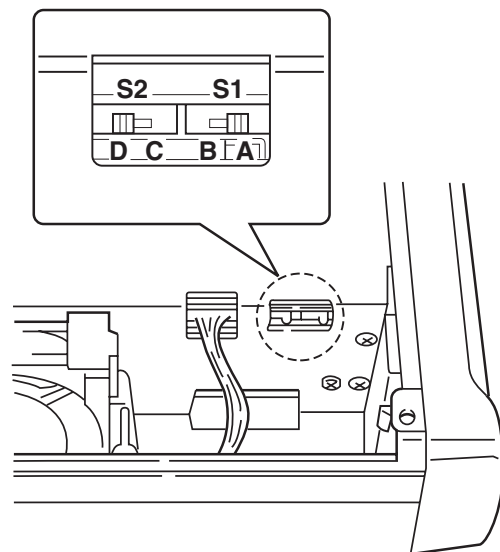

### ◇ Automatic tuner start (HF bands only)

If you want to turn ON the tuner when the VSWR is worth than 1.5:1, turn this function ON in the "Auto Start" item of the "Function" Set mode, and turn OFF the **Antenna tuner**. (p. 17-20)

**SET**(C) > Function > Tuner > **Auto Start**

### ◇ PTT tune function

The AT-180 tunes when [PTT] is pushed after the frequency is changed (more than 1%) if the AT-180 is turned ON. This function removes the 'hold down **TUNER/CALL**(L)' operation and activates with the first transmission on the new frequency. (p. 17-20)

Turn this function ON in the "PTT Start" item of the "Function" Set mode.

**SET**(C) > Function > Tuner > **PTT Start**

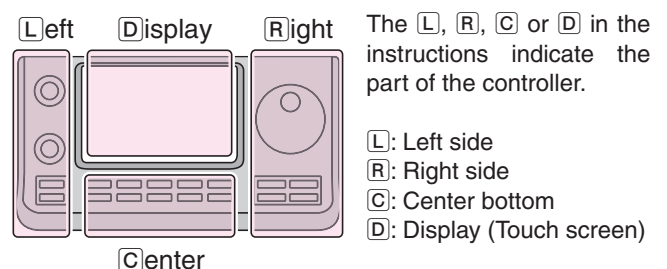

# Section 17 SET MODE

---

<b>Set mode description .....</b>	<b>17-2</b>
◇ The Set mode settings .....	17-2
<b>Set mode items and Default settings.....</b>	<b>17-3</b>
<b>Voice Memo Set mode.....</b>	<b>17-11</b>
<b>DV Set mode .....</b>	<b>17-13</b>
<b>SPEECH Set mode.....</b>	<b>17-15</b>
<b>QSO/RX Log Set mode.....</b>	<b>17-16</b>
<b>Function Set mode .....</b>	<b>17-18</b>
<b>Tone Control Set mode .....</b>	<b>17-23</b>
<b>Connectors Set mode .....</b>	<b>17-24</b>
<b>Display Set mode.....</b>	<b>17-27</b>
<b>Time Set Set mode .....</b>	<b>17-30</b>
<b>Others Set mode.....</b>	<b>17-31</b>

## Set mode description

The Set mode is used to program infrequently changed values or function settings.

**NOTE:** The Set mode is constructed in a tree structure. You may go to the next tree level, or go back a level, depending on the selected item.

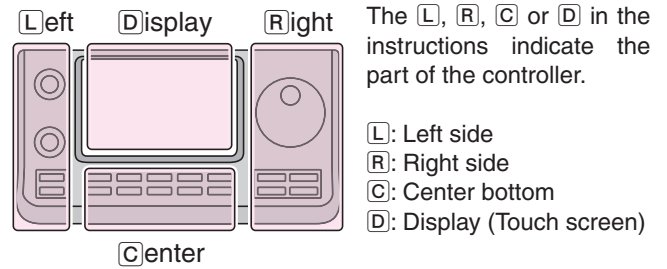

Example: Change the “Memopad Numbers” item option to “10.”

### ◆ The Set mode settings

- ① Push **SET**(**C**) to enter the Set mode.
- ② If the specified item is not displayed, touch **[▲]** or **[▼]** (**D**) one or more times to select the page.
  - If **[▲]**(**D**) or **[▼]**(**D**) is continuously held down, the pages are quickly scrolled.
  - Rotating the Dial also selects the pages.
- ③ Touch a desired item to go to the next level.
- ④ Repeat steps ② and ③ to show the desired item’s setting screen.
  - To go back the previous tree level, touch **[↶]**(**D**), or **MENU**(**C**).
- ⑤ Touch a desired option shown on the display, or **[+]**/**[−]**(**D**) to adjust a level.
  - When you touch an option, it is automatically saved and the screen returns to the previous display.
  - Rotating the Dial also adjusts the level.
  - Push **QUICK**(**C**), and then touch “Default” to reset to the default setting, if desired.
  - To set other item, touch **[↶]**(**D**), or **MENU**(**C**) to go back a tree level.
- ⑥ Push **SET**(**C**) to exit the Set mode.

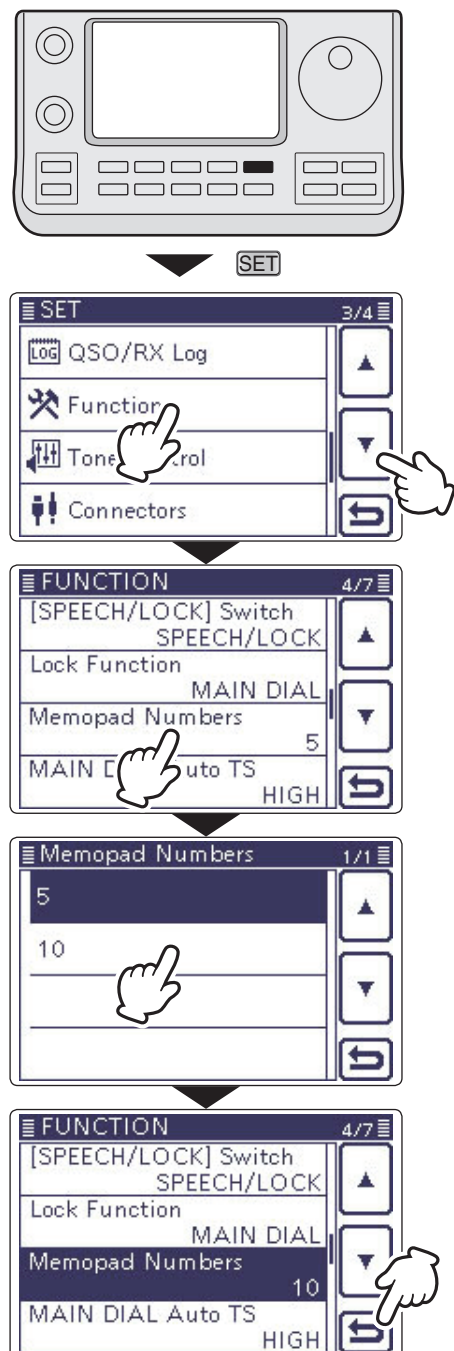



## Set mode items and Default settings

- Call sign (Section 9)
- RX History (Section 9)
- MY Station (Section 7)
- GPS (Section 10)
- SD Card (Section 13)

/// **NOTE:** The default settings shown below in bold are for the USA version.  
 /// The default settings may differ, depending on your transceiver version.

<b>Voice Memo</b>		In this item, set the TX/RX voice recording options.
QSO Recorder		
<<REC Start>>*		Starts recording the TX/RX audio.
Play Files*		Selects to playback or delete the recorded audio.
Recorder Set		
REC Mode	<b>TX&amp;RX</b> or RX Only	Selects to record the TX audio or not.
RX REC Condition	Always or <b>Squelch Auto</b>	Selects whether or not the squelch status affects the RX voice audio recording.
File Split	OFF or <b>ON</b>	Selects whether or not to automatically create a new file after each transmission, reception, or each time the squelch opens or closes. Even if the squelch is closed, a new file is created when the "RX REC Condition" item is set to "Squelch Auto."
PTT Auto REC	<b>OFF</b> or ON	Turns the PTT Automatic Recording function ON or OFF.
Player Set		
Skip Time	3sec, 5sec, <b>10sec</b> or 30sec	Sets the Skip time to rewind or forward the recorded audio when you push the fast-rewind or fast-forward key during playback.
DV Auto Reply*		Records a voice audio to use for the Auto Reply function in the DV mode.

\* Be sure to insert the SD card into the transceiver before selecting these items.

<b>DV Set</b>		In this item, set infrequently changed values or functions in the DV mode.
Standby Beep	OFF, <b>ON</b> or ON (to me: High Tone)	Selects whether or not to sound a beep after a received signal disappears.
Auto Reply	<b>OFF</b> , ON or Voice	Selects whether or not to automatically reply to a call addressed to your own call sign.
DV Data TX	PTT or <b>Auto</b>	Selects to manually or automatically transmit low speed data.
Digital Monitor	<b>Auto</b> , Digital or Analog	Selects the DV mode RX monitoring when [XFC] is held down.
Digital Repeater Set	OFF or <b>ON</b>	Turns the digital repeater setting function ON or OFF. This function is usable in any DV mode except the DR mode.
RX Call Sign Write	<b>OFF</b> or Auto	Turns the RX call sign automatic write function ON or OFF. This function is usable in any DV mode except the DR mode.
RX Repeater Write	<b>OFF</b> or Auto	Turns the repeater call sign automatic write function ON or OFF. This function is usable in any DV mode except the DR mode.
DV Auto Detect	<b>OFF</b> or ON	Turns the DV mode automatic detect function ON or OFF.
RX Record (RPT)	<b>ALL</b> or Latest Only	Selects whether to record all calls or only the latest call, when the received signal includes a status message ("UR?" or "RPT?") that is sent back from the access repeater.
BK	<b>OFF</b> or ON	Turns the BK (Break-in) function ON or OFF. The BK function allows you to break into a conversation between two stations with call sign squelch enabled.
EMR	<b>OFF</b> or ON	Turns the EMR (Enhanced Monitor Request) communication mode ON or OFF.
EMR AF Level	0%~ <b>50%</b> ~100%	Sets the audio output level when an EMR mode signal is received.

## Set mode items and Default settings (Continued)

/// **NOTE:** The default settings shown below in bold are for the USA version.  
 /// The default settings may differ, depending on your transceiver version.

<b>SPEECH</b>		
	In this item, set the Speech options.	
RX Call Sign SPEECH	OFF, <b>ON (Kerchunk)</b> or ON (All)	Selects the RX call sign speech function option while ON, or turn it OFF.
RX>CS SPEECH	OFF or <b>ON</b>	Turns the RX>CS Speech function ON or OFF.
S-Level SPEECH	OFF or <b>ON</b>	Turns the Signal Strength Level Speech function ON or OFF.
MODE SPEECH	<b>OFF</b> or ON	Turns the Operating Mode Speech function ON or OFF.
SPEECH Language	<b>English</b> or Japanese	Selects either English or Japanese as the desired speech language.
Alphabet	<b>Normal</b> or Phonetic Code	Selects the alphabet character announcement type.
SPEECH Speed	Slow or <b>Fast</b>	Selects Slow or Fast speech speed.
SPEECH Level	0%~ <b>50%</b> ~100%	Sets the volume level for the voice synthesizer.
<b>QSO/RX Log</b>		
	In this item, set the QSO/RX History Log options.	
QSO Log* <sup>1</sup>	<b>OFF</b> or ON	Selects whether or not to make a communication log on the SD card.
RX History Log* <sup>1</sup>	<b>OFF</b> or ON	Selects whether or not to make a DV mode's receive history log on the SD card.
<b>CSV Format</b>		
Separator/Decimal	<b>Sep [.] Dec [.]</b> * <sup>2</sup> , Sep [;] Dec [.] or Sep [;] Dec [.]	Selects the separator and the decimal character for the CSV format.
Date	yyyy/mm/dd, <b>mm/dd/yyyy</b> * <sup>2</sup> or dd/mm/yyyy	Selects the date format.
* <sup>1</sup> Be sure to insert the SD card into the transceiver before selecting these items.		
* <sup>2</sup> The default value may differ, depending on the transceiver version.		

## Set mode items and Default settings (Continued)

/// **NOTE:** The default settings shown below in bold are for the USA version.  
 /// The default settings may differ, depending on your transceiver version.

Function	In this item, set the function options.	
Monitor	<b>OFF</b> or ON	Selects whether or not to monitor your transmit signal in any mode other than CW.
Monitor Level	0%~ <b>50%</b> ~100%	Sets the monitor level.
Beep Level	0%~ <b>50%</b> ~100%	Sets the beep output level.
Beep Level Limit	OFF or <b>ON</b>	Selects whether or not to limit the volume to the specified level, and further rotation of the [AF] control will not increase the level.
Beep (Confirmation)	OFF or <b>ON</b>	Turns the confirmation beep tones ON or OFF.
<b>Band</b> Edge Beep	OFF, <b>ON (Default)</b> , ON (User) or ON (User) & TX Limit	Selects whether or not to sound a beep when you tune outside of, or back into the amateur band's frequency range.
User Band Edge	<b>1: 1.800.000–1.999.999</b> <b>2: 3.500.000–3.999.999</b> <b>3: 5.255.000–5.405.000</b> <b>4: 7.000.000–7.300.000</b> <b>5: 10.100.000–10.150.000</b> <b>6: 14.000.000–14.350.000</b> <b>7: 18.068.000–18.168.000</b> <b>8: 21.000.000–21.450.000</b> <b>9: 24.890.000–24.990.000</b> <b>10: 28.000.000–29.700.000</b> <b>11: 50.000.000–54.000.000</b> <b>12: 144.000.000–148.000.000</b> <b>13: 430.000.000–450.000.000</b> <b>14~30: (blank)</b>	Selects the user band frequency range to sound a beep when the Band Edge Beep function is set to "ON (User)" or "ON (User) & TX Limit," and you tune outside of, or back into a programmed range.
RF/SQL Control	Auto, SQL or <b>RF+SQL</b>	Select the function of the [RF/SQL] control.
TX Delay		
HF	<b>OFF</b> , 10ms, 15ms, 20ms, 25ms or 30ms	Sets the transmission's timing of the IC-7100 to prevent any external equipment that is connected from damage by the transmitted RF.
50M	<b>OFF</b> , 10ms, 15ms, 20ms, 25ms or 30ms	See HF above.
144M	<b>OFF</b> , 10ms, 15ms, 20ms, 25ms or 30ms	See HF above.
430M	<b>OFF</b> , 10ms, 15ms, 20ms, 25ms or 30ms	See HF above.
Time-Out Timer	<b>OFF</b> , 3min, 5min, 10min, 20min or 30min	Selects the Time-Out Timer time options to prevent an accidental prolonged transmission.
PTT Lock	<b>OFF</b> or ON	Selects whether or not to inhibit transmission.
<b>SPLIT/DUP</b>		
Quick SPLIT	OFF or <b>ON</b>	Turns the Quick SPLIT function ON or OFF.
SPLIT Offset	–9.999 MHz~ <b>0.000 MHz</b> ~+9.999 MHz	Sets the frequency offset for the Split function.
SPLIT LOCK	<b>OFF</b> or ON	Turns the SPLIT LOCK function ON or OFF.
DUP Offset	0.0000 MHz~9.9999 MHz (The default value may differ, depending on the frequency band and the transceiver version.)	Sets the frequency offset for repeater operation.
One Touch Repeater	<b>DUP–</b> or DUP+	Selects the <b>duplex</b> direction for the One Touch Repeater function.
Auto Repeater	OFF, <b>ON (DUP)</b> or ON (DUP,TONE)	Turns the Auto Repeater function ON or OFF.
Tuner		
Auto Start	<b>OFF</b> or ON	Turns the automatic <b>antenna tuner</b> function ON or OFF.

## Set mode items and Default settings (Continued)

/// **NOTE:** The default settings shown below in bold are for the USA version.  
 /// The default settings may differ, depending on your transceiver version.

PTT Start [TUNER] Switch	<b>OFF</b> or ON Manual or <b>Auto</b>	Turns the PTT Tuner Start function ON or OFF. Selects whether or not to store the AT-180's status by each <b>band</b> .
[SPEECH/LOCK] Switch	<b>SPEECH/LOCK</b> , LOCK/SPEECH	Selects the function for <b>[SPEECH/LOCK]</b> when pushed or held down.
Lock Function	<b>MAIN DIAL</b> or PANEL	Select the target to be locked when the Lock function is activated.
Memopad Numbers	<b>5</b> or 10	Sets the number of usable memopad channels.
MAIN DIAL Auto TS	OFF, LOW or <b>HIGH</b>	Selects an option for the automatic tuning step function. When rapidly rotating the main dial, the tuning step automatically changes according to the setting.
MIC Up/Down Speed [NOTCH] Switch (SSB)	Slow or <b>Fast</b> Auto, Manual or <b>Auto/Manual</b>	Selects the microphone's <b>[▲]/[▼]</b> key speed. Selects the notch function for the SSB mode.
[NOTCH] Switch (AM)	Auto, Manual or <b>Auto/Manual</b>	Selects the notch function for the AM mode.
SSB/CW Sync Tuning	<b>OFF</b> or ON	Turns the Synchronous Tuning function ON or OFF to shift the operating frequency by the offset amount to keep receiving a signal when the operating mode is changed between SSB and CW.
CW Normal Side	<b>LSB</b> or USB	Sets the <b>carrier</b> point for CW normal mode operation to the LSB side or the USB side.
VOICE 1st Menu	VOICE-Root or <b>VOICE-TX</b>	Select whether or not to directly select the "VOICE TX" screen, skipping the "VOICE" screen.
KEYER 1st Menu	KEYER-Root or <b>KEYER-SEND</b>	Select whether or not to directly select the "KEYER SEND" screen, skipping the "KEYER" screen.
Speaker Out	OFF or <b>ON</b>	Selects to mute the speaker output.
MIC AF Out	<b>OFF</b> or ON	Selects to output the received audio from the [MIC] connector.
RC MIC [F-1]	---, P.AMP/ATT, <b>AGC</b> , NB, <b>NR</b> , NOTCH, RIT, AUTOTUNE/RX>CS, TS, MPAD, M-CLR, <b>BANK</b> , <b>SPLIT</b> , A/B, DUP, TONE/DSQL, COMP, TBW, METER, DR, FROM/TO (DR), <b>SCAN</b> , Voice TX (T1)	The functions listed to the left can be set to [F-1] of the optional HM-151 REMOTE CONTROL MIC.
[F-2]	---, P.AMP/ATT, AGC, <b>NB</b> , NR, <b>NOTCH</b> , RIT, AUTOTUNE/RX>CS, TS, MPAD, M-CLR, BANK, <b>SPLIT</b> , <b>A/B</b> , DUP, TONE/DSQL, COMP, TBW, METER, DR, FROM/TO (DR), SCAN, Voice TX (T1)	The functions listed to the left can be set to [F-2] of the optional HM-151 REMOTE CONTROL MIC.
Mode Select	<input type="checkbox"/> SSB, <input type="checkbox"/> CW, <input type="checkbox"/> RTTY, <input type="checkbox"/> AM, <input type="checkbox"/> FM, <input type="checkbox"/> WFM, <input type="checkbox"/> DV <b>(All boxes are checked.)</b>	Disables the mode selection of the optional HM-151 REMOTE CONTROL MIC, to simplify operation.
Power OFF (With No Controller)	OFF or <b>ON</b>	Selects whether or not to automatically turn OFF the transceiver when the controller is disconnected from the transceiver.
REF Adjust	0 %~100 %	Sets a number to adjust for a zero beat with a standard signal such as WWV or WWVH, for frequency calibration.

**Set mode items and Default settings (Continued)**

/// **NOTE:** The default settings shown below in bold are for the USA version.  
 /// The default settings may differ, depending on your transceiver version.

<b>Tone Control</b>		In this item, set the RX/TX tone control options.	
<b>RX</b>			
<b>SSB</b>			
RX HPF/LPF	---- - ----, 100~2000 – 500~2400		Sets the high-pass <b>filter</b> or low-pass filter of the receive audio.
RX Bass	-5~ <b>0</b> ~+5		Sets the bass level of the receive audio.
RX Treble	-5~ <b>0</b> ~+5		Sets the treble level of the receive audio.
<b>AM</b>			
RX HPF/LPF	---- - ----, 100~2000 – 500~2400		Sets the high-pass filter or low-pass filter of the receive audio.
RX Bass	-5~ <b>0</b> ~+5		Sets the bass level of the receive audio.
RX Treble	-5~ <b>0</b> ~+5		Sets the treble level of the receive audio.
<b>FM</b>			
RX HPF/LPF	---- - ----, 100~2000 – 500~2400		Sets the high-pass filter or low-pass filter of the receive audio.
RX Bass	-5~ <b>0</b> ~+5		Sets the bass level of the receive audio.
RX Treble	-5~ <b>0</b> ~+5		Sets the treble level of the receive audio.
<b>DV</b>			
RX HPF/LPF	---- - ----, 100~2000 – 500~2400		Sets the high-pass filter or low-pass filter of the receive audio.
RX Bass	-5~ <b>0</b> ~+5		Sets the bass level of the receive audio.
RX Treble	-5~ <b>0</b> ~+5		Sets the treble level of the receive audio.
<b>WFM</b>			
RX Bass	-5~ <b>0</b> ~+5		Sets the bass level of the receive audio.
RX Treble	-5~ <b>0</b> ~+5		Sets the treble level of the receive audio.
<b>CW</b>			
RX HPF/LPF	---- - ----, 100~2000 – 500~2400		Sets the high-pass filter or low-pass filter of the receive audio.
<b>RTTY</b>			
RX HPF/LPF	---- - ----, 100~2000 – 500~2400		Sets the high-pass filter or low-pass filter of the receive audio.
<b>TX</b>			
<b>SSB</b>			
TX Bass	-5~ <b>0</b> ~+5		Sets the bass level of the transmit audio.
TX Treble	-5~ <b>0</b> ~+5		Sets the treble level of the transmit audio.
TBW (WIDE)	<b>100</b> , 200, 300, 500 – 2500, 2700, 2800, <b>2900</b>		Sets the lower and higher cut-off frequencies to change the transmission passband width for the wide setting.
TBW (MID)	100, 200, <b>300</b> , 500 – 2500, <b>2700</b> , 2800, 2900		Sets the lower and higher cut-off frequencies to change the transmission passband width for the mid setting.
TBW (NAR)	100, 200, 300, <b>500</b> – <b>2500</b> , 2700, 2800, 2900		Sets the lower and higher cut-off frequencies to change the transmission passband width for the narrow setting.
<b>AM</b>			
TX Bass	-5~ <b>0</b> ~+5		Sets the bass level of the transmit audio.
TX Treble	-5~ <b>0</b> ~+5		Sets the treble level of the transmit audio.
<b>FM</b>			
TX Bass	-5~ <b>0</b> ~+5		Sets the bass level of the transmit audio.
TX Treble	-5~ <b>0</b> ~+5		Sets the treble level of the transmit audio.
<b>DV</b>			
TX Bass	-5~ <b>0</b> ~+5		Sets the bass level of the transmit audio.
TX Treble	-5~ <b>0</b> ~+5		Sets the treble level of the transmit audio.

## Set mode items and Default settings (Continued)

/// **NOTE:** The default settings shown below in bold are for the USA version.  
 /// The default settings may differ, depending on your transceiver version.

<b>Connectors</b>		
In this item, set the external connector's options.		
USB Audio SQL	<b>OFF (OPEN)</b> or ON	Selects whether or not to output the audio from the [USB] connector, according to the squelch state (open or closed).
ACC/USB Output Select	<b>AF</b> or IF	Sets the [USB] connector and the [ACC] socket usage to received audio output or the IF output for DRM (Digital Radio Mondiale).
ACC/USB AF Level	0 %~ <b>50</b> %~100 %	Sets the audio output level at the [ACC] socket and the [USB] connector.
ACC/USB IF Level	0 %~ <b>50</b> %~100 %	Sets the IF output level at the [ACC] socket and the [USB] connector.
ACC MOD Level	0 %~ <b>50</b> %~100 %	Sets the input modulation level at the [ACC] socket.
DATA MOD Level	0 %~ <b>50</b> %~100 %	Sets the input modulation level at the [DATA] jack.
USB MOD Level	0 %~ <b>50</b> %~100 %	Sets the input modulation level at the [USB] connector.
DATA OFF MOD	MIC, ACC, <b>MIC,ACC</b> or USB	Selects the connector(s) for the desired modulation to input when the data mode is not used.
DATA MOD	MIC, <b>ACC</b> , MIC,ACC or USB	Selects the connector(s) for the desired modulation to input when the data mode is used.
<b>External Keypad</b>		
VOICE	<b>OFF</b> or ON	Selects whether or not to transmit voice memory contents using the external keypad.
KEYER	<b>OFF</b> or ON	Selects whether or not to transmit keyer memory contents using the external keypad.
RTTY	<b>OFF</b> or ON	Selects whether or not to transmit RTTY memory contents using the external keypad.
<b>CI-V</b>		
CI-V Baud Rate	300, 1200, 4800, 9600, 19200 or <b>Auto</b>	Sets the CI-V code transfer speed.
CI-V Address	01h~ <b>88h</b> ~DFh	Sets the transceiver's unique CI-V hexadecimal address code.
CI-V Transceive	OFF or <b>ON</b>	Turns the CI-V Transceive function ON or OFF.
<b>USB2/DATA1 Function</b>		
USB2 Function	<b>OFF</b> , RTTY Decode or DV Data	Selects the use of the COM port (USB2).
DATA1 Function	OFF, RTTY Decode, DV Data or <b>GPS</b>	Select the use of the [DATA1] jack.
GPS Out	<b>OFF</b> or DATA1 → USB2	Selects whether or not to output the data to the COM port (USB2) when data is input from a GPS receiver through the [DATA1] jack.
DV Data/GPS Out Baud	<b>4800</b> or 9600	Sets the DV or GPS data transfer speed
RTTY Decode Baud	300, 1200, 4800, <b>9600</b> or 19200	Sets the RTTY decode monitor speed.
VSEND Select	OFF, UHF or <b>VHF/UHF</b>	Selects the <b>band</b> to use for the [ACC] socket's pin 7 (VSEND usage).
9600bps Mode	<b>OFF</b> or ON	Selects whether or not to allow data transmission at 9600 bps.

## Set mode items and Default settings (Continued)

/// **NOTE:** The default settings shown below in bold are for the USA version.  
 /// The default settings may differ, depending on your transceiver version.

<b>Display</b>	In this item, set the transceiver's display options.	
LCD Contrast	0%~ <b>50%</b> ~100%	Sets the contrast level of the LCD.
LCD Backlight	0%~ <b>50%</b> ~100%	Sets the backlight level of the LCD.
Key Backlight	0%~ <b>50%</b> ~100%	Sets the backlight level of the key.
Meter Peak Hold	OFF or <b>ON</b>	Turns the Meter Peak Hold function ON or OFF.
BW Popup (PBT)	OFF or <b>ON</b>	Selects whether or not to display the <b>PBT</b> shifting value and the passband width while rotating the TWIN-PBT control.
BW Popup (FIL)	OFF or <b>ON</b>	Selects whether or not to display the IF filter width and shifting value when the IF filter is switched.
RX Call Sign Display	OFF, <b>Auto</b> or Auto (RX Hold)	Selects whether or not to display the call sign of the caller station when a call is received.
RX Message Display	OFF or <b>Auto</b>	Selects whether or not to display and scroll a received message.
Reply Position Display	OFF or <b>ON</b>	Selects whether or not to display the caller's position data when the data is included in the Auto Reply signal.
TX Call Sign Display	OFF, <b>Your Call Sign</b> or My Call Sign	Selects whether or not to display My or Your call sign while transmitting.
Scroll Speed	Slow or <b>Fast</b>	Sets the scrolling speed of the message, call sign, or other text, that are displayed on the transceiver's LCD.
VOICE TX Name Display	OFF or <b>ON</b>	Selects whether or not to display the voice TX memory name on the "VOICE TX" screen.
KEYER Memory Display	OFF or <b>ON</b>	Selects whether or not to display the keyer memory contents on the "KEYER SEND" screen.
Opening Message	OFF or <b>ON</b>	Selects whether or not to display the opening message at power ON.
Power ON Check	OFF or <b>ON</b>	Selects whether or not to display the RF Power, RIT, Auto Power OFF condition at power ON.
Display Language	<b>English</b> or Japanese	Sets the screen display language type in the DR mode or Menu mode. When the System Language is "English," this item disappears.
System Language	<b>English</b> or Japanese	Sets the system language of the transceiver.
<b>Time Set</b>	In this item, set the time options.	
Date/Time		
DATE	<b>2000/01/01</b> ~2099/12/31	Sets the date.
TIME	<b>0:00</b> ~23:59	Sets the time.
GPS Time Correct	OFF or <b>Auto</b>	Selects whether or not to automatically correct the time data by a received GPS sentence.
UTC Offset	-14:00~ <b>±0:00</b> ~+14:00	Sets the time difference between UTC (Universal Time Coordinated) and the local time.
Clock Display	<b>Local</b> or UTC	Sets the clock display mode.
Auto Power OFF	<b>OFF</b> , 30min, 60min, 90min or 120min	Sets to automatically turn OFF the transceiver power after no operation is made during this set period.



**Set mode items and Default settings (Continued)**

/// **NOTE:** The default settings shown below in bold are for the USA version.  
 /// The default settings may differ, depending on your transceiver version.

<b>Others</b>	In this item, set other options.
<b>Information</b>	
Version	Shows the transceiver's firmware version number.
<b>Clone</b>	
Clone Mode	Reads or writes the CS-7100 data to or from the PC, and/or receives data from a Master transceiver.
Clone Master Mode	Writes your IC-7100 (Master) data to another IC-7100 (Sub).
Touch Screen Calibration	Adjusts the touch screen.
<b>Reset</b>	
Partial Reset	Returns all settings to their default values, without clearing the memory contents, <b>call sign</b> memories or repeater lists.
All Reset	Clears all programming and memories, and return all settings to their default values.

## Voice Memo Set mode

### <<REC Start>>

Voice Memo > QSO Recorder > <<REC Start>>

Insert an SD card into the transceiver before selecting this item.

Touch [<<REC Start>>] to start voice recording.

- “Recording started.” appears.
- [<<REC Stop>>] is displayed while recording.



Once recording has started, the recording will continue, even the transceiver is rebooted.  
To stop the recording, touch [<<REC Stop>>].

### Play Files

Voice Memo > QSO Recorder > Play Files (PLAY FILES)

Insert an SD card into the transceiver before selecting this item.

Do the following steps to play back the recorded audio on the SD card.

Touch [Play Files], and folders on the SD card are displayed.

- These folders contain the stored files.

#### Playing back

- ① Touch [▲] or [▼], or rotate [DIAL] to select the folder that includes the desired file to play back, and then touch the folder.
- ② Touch [▲] or [▼], or rotate [DIAL] to select the file to play back, and then touch the file.
  - The VOICE PLAYER screen is displayed and the selected file is played back.
  - See “Operation while playing back” for forwarding or rewinding. (p. 14-5)
- ③ Push [MENU] or touch [↵] on the display to stop the playback.
  - Returns to the file list screen.

#### NOTE:

- The folder name is automatically created, as shown in the example below:  
(Example) Recording date: 2013/3/1  
Folder name: 20130301
- The file name is automatically created, as shown in the example below:  
(Example) Recording date: 2013/3/1 15:30:00  
File name: 20130301\_153000
- The voice audio is recorded onto an SD card, and saved in the “wav” format.  
The recorded voice audio can also be played back on a PC.  
The extension, “wav,” is not displayed on the transceiver’s screen.

### REC Mode

(Default: TX&RX)

Voice Memo > QSO Recorder > Recorder Set > REC Mode (REC Mode)

Records both the transmitted and received audio as the default setting.

- TX&RX: Records both the transmitted and received audio.
- RX Only: Records only the received audio.

#### When transmitting while recording

When “OFF” is selected in File Split, the recording is paused. After you stop transmitting, the recording resumes.

When “ON” is selected in File Split, a new file is automatically created, and the transmitted audio is recorded into the new one.

### RX REC Condition

(Default: Squelch Auto)

Voice Memo > QSO Recorder > Recorder Set > RX REC Condition (RX REC Condition)

Select whether or not the squelch status affects the RX voice audio recording.

- Always: The transceiver always records the RX audio regardless of the squelch status.
- Squelch Auto: The transceiver records the RX audio only when a signal is received (the squelch is opened).  
When the squelch closes while recording, the recording will continue for 2 seconds, and then pause.

When “ON” is selected in File Split, and if the squelch either opens or closes while recording, a new file is automatically created.

Voice Memo Set mode (Continued)

**File Split (Default: ON)**

Voice Memo > QSO Recorder > Recorder Set > File Split (File Split)

Turn the File Split function ON or OFF.

- OFF: When the recording starts, a new file is automatically created in the folder of the SD card. The audio is continuously recorded into the file, even if transmission and reception, or the squelch status (open and close) is switched. If the file size exceeds 2 GB, a new file is automatically created in the same folder, and the audio is recorded there.
- ON: When the recording starts, a new file is automatically created in the folder of the SD card. During recording, and if transmission and reception, or squelch status (open and close) is switched, a new file is automatically created in the same folder, and the audio is saved into the new one.

**PTT Auto REC (Default: OFF)**

Voice Memo > QSO Recorder > Recorder Set > PTT Auto REC (PTT Auto REC)

Turn the PTT Automatic Recording function ON or OFF.

Recording starts when a signal is transmitted from an external speaker microphone, the VOX functions or a CI-V command is sent.

- OFF: The recording does not start even if a signal is transmitted.
- ON: The recording automatically starts when a signal is transmitted.
 

The recording will stop when:

  - No signal is transmitted for 10 seconds after the last transmission.
  - No signal is received for 10 seconds after the last transmission.
    - 10 minutes after the last transmission while the squelch is open (SSB/CW/RTTY/AM modes.)
    - A signal is received within 10 seconds after the last transmission, the received signal is also recorded. A signal is received within 10 seconds after the last reception, the received signal is also recorded.
  - The frequency or operating mode is changed while transmitting.
  - The operating method (V/M, CALL, DR, M-CH, Band Stacking Register, and so on) has been changed.

**Skip Time (Default: 10sec)**

Voice Memo > QSO Recorder > Player Set > Skip Time (Skip Time)

Set the SkipTimer to 3, 5, 10 or 30 seconds to rewind or skip forward for this set period when you push the fast-rewind or fast-forward key.

- See "Operation while playing back" for forwarding or rewinding. (p. 14-5)

**DV Auto Reply**

Voice Memo > DV Auto Reply (DV AUTO REPLY)

Up to 10 seconds of audio can be recorded for the automatic reply function.

See page 9-15 for details of recording audio.

⚡ Be sure to insert an SD card into the transceiver before selecting this item.

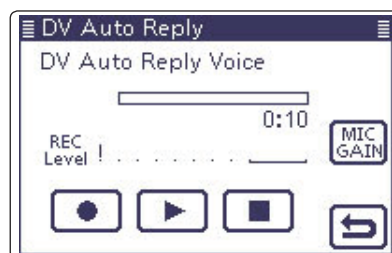

## DV Set mode

### Standby Beep (Default: ON)

DV Set > Standby Beep (Standby Beep)

Turn the standby beep function ON or OFF.

This function sounds a beep after a received signal disappears.

- OFF: Turns the function OFF.
- ON: Turns the function ON to sound a beep.
- ON (to me: High Tone): Turns the function ON to sound a beep. If the signal is addressed to your **call sign**, a high pitch beep sounds.

#### NOTE:

- Even if “Beep (Confirmation)” of the Function screen is OFF, the standby beep sounds.
- The standby beep output level can be set in “Beep Level” of the Function screen.

### Auto Reply (Default: OFF)

DV Set > Auto Reply (Auto Reply)

Set the automatic reply function to ON, OFF or Voice.

This function automatically replies to a call addressed to your own call sign, even if you are away from the transceiver.

When “ON” or “Voice” is selected, the automatic reply function is automatically turned OFF when you push [PTT].

- OFF: The automatic reply function is OFF.
- ON: Replies with your own call sign. (No audio reply is sent)
- Voice: Replies with your call sign and any Auto Reply message recorded on the SD (up to 10 seconds).  
If no SD card is inserted or no message is recorded, only your call sign is transmitted. The transmitted audio will be heard from the speaker.

### DV Data TX (Default: Auto)

DV Set > DV Data TX (DV Data TX)

Select whether to manually or automatically transmit slow-speed data.

- PTT: Push [PTT] to manually transmit the input data.
- Auto: When data is input from a PC through either the [USB2] port or [DATA1] jack\*, the transceiver automatically transmits it.  
\*\*“USB2 Function” or “DATA1 Function” item must be set to “DV Data.” (p. 17-25)

### Digital Monitor (Default: Auto)

DV Set > Digital Monitor (Digital Monitor)

Select the receive mode when [XFC] is held down in the DV mode.

- Auto: Receives in the DV mode or the FM mode, depending on the received signal.
- Digital: Monitors in the DV mode.
- Analog: Monitors in the FM mode.

### Digital Repeater Set (Default: ON)

DV Set > Digital Repeater Set (Digital Repeater Set)

Turn the digital repeater setting function ON or OFF.

In any DV mode except for the DR mode, and when accessing a repeater that has a call sign that is different than the transceiver’s setting, this function reads the repeater’s transmit signal and automatically sets the repeater call sign.

- OFF: Turns the function OFF.
- ON: Automatically sets the repeater call sign.

### RX Call Sign Write (Default: OFF)

DV Set > RX Call Sign Write (RX Call Sign Write)

Set the RX call sign automatic write function to Auto or OFF.

When receiving a call addressed to your own call sign in any DV mode except for the DR mode, this function automatically sets the caller station call sign into “UR.”

- OFF: Turns the function OFF.
- Auto: Automatically sets the call sign of the caller station into “UR.”

### RX Repeater Write (Default: OFF)

DV Set > RX Repeater Write (RX Repeater Write)

Set the repeater call sign automatic write function to Auto or OFF.

When receiving a call addressed to your own call sign through a repeater in any DV mode except for the DR mode, this function automatically sets the call sign of the repeater into “R1” or “R2.”

- OFF: Turns the function OFF.
- Auto: Automatically sets the call sign of the repeater into “R1” and/or “R2.”

## DV Set mode (Continued)

**DV Auto Detect** (Default: OFF)

DV Set &gt; DV Auto Detect (DV Auto Detect)

Turn the DV mode automatic detect function ON or OFF.

If you receive a non-digital signal during DV mode operation, this function automatically switches to the FM mode.

- OFF: Turns the function OFF. The operating mode is fixed to the DV mode.
- ON: Automatically selects the FM mode for temporary operation.

**RX Record (RPT)** (Default: ALL)

DV Set &gt; RX Record (RPT) (RX Record (RPT))

The transceiver can record the data of up to 50 individual calls.

When the received signal includes a status message ("UR?" or "RPT?") that is sent back from the access repeater, you can record up to 50 messages or only the latest one, in the Received Call Record.

- ALL: Records up to 50 calls.
- Latest Only: Records only the latest call.

**BK** (Default: OFF)

DV Set &gt; BK (BK)

The BK (Break-in) function allows you to break into a conversation, where the two other stations are communicating with **call sign** squelch enabled.

- OFF: Turns the function OFF.
- ON: Turns the function ON.  
"BK" appears on the display.

/// **NOTE:** The BK function is automatically turned OFF when transceiver is turned OFF.

**EMR** (Default: OFF)

DV Set &gt; EMR (EMR)

The EMR (Enhanced Monitor Request) communication mode can be used in the digital mode. In the EMR mode, no call sign setting is necessary.

When an EMR mode signal is received, the audio (voice) will be heard at the specified level even if the volume setting level is set to minimum level, or digital call sign/digital code squelch is in use.

- OFF: Turns the function OFF.
- ON: Turns the function ON.  
"EMR" appears on the display.

/// **NOTE:** The EMR function is automatically turned OFF when transceiver is turned OFF.

**EMR AF Level** (Default: 50%)

DV Set &gt; EMR AF Level (EMR AF Level)

Set the audio output level to between 0% (no audio), 1% (minimum) and 100% (maximum) for when an EMR communication mode signal is received.

When an EMR signal is received, the audio will be heard at the set level, or the [AF] control level, whichever is higher.

To disable the setting, set it to "0%."

/// **NOTE:** After an EMR signal disappears, the audio level will remain at the EMR level. In this case, rotate [AF] to adjust the audio level.

## SPEECH Set mode

### RX Call Sign SPEECH (Default: ON (Kerchunk))

SPEECH > RX Call Sign SPEECH (RX Call Sign SPEECH)

Turn the RX call sign speech function ON or OFF for calls received in the DV mode.

- OFF: No announcement is made even when a call is received.
- ON (Kerchunk): The caller station's call sign is announced only when it makes a short transmission.
- ON (All): The caller station's call sign is always announced.

#### NOTE:

- When the digital squelch function is used, the calling station's call sign is not announced if the received signal is not addressed to your call sign, or does not include a matched digital code.
- When the repeater returns "UR?" or "RPT?," the calling station's call sign is not announced.
- When a call is received during scanning, the scan resumes even while the transceiver announcing.
- A "r" or a note after a call sign are not announced.
- When a call is received during an announcement, the received audio is heard after cancelling the announcement.

### RX>CS SPEECH (Default: ON)

SPEECH > RX>CS SPEECH (RX>CS SPEECH)

Turn the RX>CS Speech function ON or OFF. The RX>CS Speech function announces the station call sign that is selected from a Received Call Record by holding down **AUTO TUNE[RX>CS]**.

- OFF: The station call sign is not announced.
- ON: The station call sign is announced.

### S-Level SPEECH (Default: ON)

SPEECH > MODE SPEECH (MODE SPEECH)

Turn the Signal strength level Speech function ON or OFF.

- OFF: Only the operating frequency is announced.
- ON: The operating frequency and the signal strength level are announced.

### MODE SPEECH (Default: OFF)

SPEECH > MODE SPEECH (MODE SPEECH)

Turn the Operating Mode Speech function ON or OFF. When this function is ON, the selected operating mode is announced when the mode switch is pushed.

- OFF: The selected operating mode is not announced.
- ON: The selected operating mode is announced.

### SPEECH Language (Default: English)

SPEECH > SPEECH Language (SPEECH Language)

Set the desired announcement language to English or Japanese.

### Alphabet (Default: Normal)

SPEECH > Alphabet (Alphabet)

Select either "Normal" or "Phonetic Code" to announce the alphabet character.

- Normal: Normal code is used. (for example: A as eh, B as bee)
- Phonetic Code: Phonetic code is used. (for example: A as Alfa, B as Bravo)

### SPEECH Speed (Default: Fast)

SPEECH > SPEECH Speed (SPEECH Speed)

Set the speech speed to Fast or Slow.

### SPEECH Level (Default: 50%)

SPEECH > SPEECH Level (SPEECH Level)

Enter a volume level number between 0% (no voice), 1% (minimum) and 100% (maximum) for the voice synthesizer.

The voice synthesizer audio output level from the speaker is linked with [AF] setting.

## QSO/RX Log Set mode

### QSO Log (Default: OFF)

QSO/RX Log > QSO Log (QSO Log)

Select whether or not to make a communication log on the SD card.

The communication log is saved in the “csv” format.

Be sure to insert the SD card into the transceiver before making a communication log.

- OFF: The QSO Log function is OFF.
- ON: The QSO Log is made on the SD card.  
The transceiver starts making a log with your send contents.

#### NOTE:

- The folder name is automatically created as [IC-7100\QsoLog].
- The file name is automatically created, as shown in the example below:  
Log start date and time: 2013/3/1 15:30:00  
File name: 20130301\_153000.csv
- The log contents cannot be displayed on the transceiver.
- You can see the log contents on an SD card in a PC. (p. 17-17)

### RX History Log (Default: OFF)

QSO/RX Log > RX History Log (RX History Log)

Select whether or not to make a DV mode’s receive history log on the SD card.

The receive history log can be made on the card, and saved in the “csv” format. Be sure to insert the card into the transceiver before making a receive history log.

- OFF: The RX History Log function is OFF.
- ON : The transceiver makes a DV mode’s receive history log on the SD card.  
The transceiver starts making a receive history log when you finish to talk.

#### NOTE:

- The folder name is automatically created as [IC-7100\RxLog].
- The file name is automatically created, as shown in the example below:  
Log start date and time: 2013/3/1 15:30:00  
File name: 20130301\_153000.csv
- The log contents cannot be displayed on the transceiver.
- You can see the log contents on an SD card in a PC. (p. 17-17)

### Separator/Decimal (Default: Sep [,] Dec [.]\*)

QSO/RX Log > CSV Format > Separator/Decimal (Separator/Decimal)

Select the separator and the decimal character for the CSV format.

- Sep [,] Dec [.]: Separator is “,” and Decimal is “.” for the CSV format.
- Sep [;] Dec [.]: Separator is “;” and Decimal is “.” for the CSV format.
- Sep [;] Dec [;]: Separator is “;” and Decimal is “;” for the CSV format.

\*The default value may differ, depending on the transceiver version.

### Date (Default: mm/dd/yyyy\*)

QSO/RX Log > CSV Format > Date (Date)

Select the date format between “yyyy/mm/dd,” “mm/dd/yyyy” and “dd/mm/yyyy.” (y: year, m: month, d: day)

\*The default value may differ, depending on the transceiver version.



## QSO/RX Log Set mode (Continued)

The QSO log contents are shown below:

Content	Example		Description
TX/RX	TX	RX	Transmission and reception
Date	12/23/2012 13:51:48	12/23/2012 13:51:48	Date and time the call was started.
Frequency	438.010000	438.010000	Operating frequencies (When Duplex is set, the frequencies of the called are displayed.)
Mode	DV	DV	Operating mode (All mode)
My Latitude	34.764667	34.764667	Your latitude (unit: degree) +: North latitude, -: South latitude
My Longitude	135.375333	135.375333	Your longitude (unit: degree) +: East longitude, -: West longitude
My Altitude	50.5	50.5	Your altitude (unit: m) Records to one decimal place.
RF Power	100%	(Blank)	TX output power level
S Meter	(Blank)	S0	The relative signal strength of the receive signal (in sixteen levels)
RPT Call Sign	JP3YHJ A	JP3YHJ A	Repeater <b>call sign</b> (DV mode only)
TX Call Sign	CQCQCQ	(Blank)	TX Call sign (DV mode only)
RX Call Sign	(Blank)	JA3YUA A	RX Call sign (DV mode only)
RX Latitude	(Blank)	34.764667	Caller's latitude, if sent. (unit: degree) +: North latitude, -: South latitude Records only when you receive in the DV mode.
RX Longitude	(Blank)	135.375333	Caller's longitude, if sent. (unit: degree) +: East longitude, -: West longitude Records only when you receive in the DV mode.
RX Altitude	(Blank)	30.5	Caller's altitude, if sent. (unit: m) Records only when you receive in the DV mode.

The RX History log contents are shown below:

Content	Example	Description
Frequency	438.010000	RX Frequency
Mode	DV	Operating mode (DV is fixed)
Caller	JA3YUA A	Call sign of the caller station
/	7100	Note after the call sign
Called	CQCQCQ	Call sign of the called station
Rx RPT1	JP3YHH G	Access repeater call sign of the caller station or the gateway repeater call sign of your local area repeater.
Rx RPT2	JP3YHJ A	Access repeater call sign of the called station
Message	Hello CQ <b>D-STAR!</b>	Message included in the received call (up to 20 characters)
Status	(Blank)	Normal: blank, Uplink: RPT UP Access repeater reply: "UR?" or "RPT?"
Received date	12/23/2012 13:51:48	Date and time the call was received Depending on the setting, the format may differ.
BK	*	BK call: "**", Normal call: Blank
EMR	*	EMR call: "**", Normal call: Blank
Latitude	34.764667	Caller's latitude, if sent. (unit: degree) +: North latitude, -: South latitude
Longitude	135.375333	Caller's longitude, if sent. (unit: degree) +: East longitude, -: West longitude
Altitude	30.5	Caller's altitude, if sent. (unit: m)
SSID	-A	Records one of (-0), -1 to -15 and -A to -Z.
GPS-A Symbol	Car	Icon: Converts to text None: Code
Course	123	Caller's course (unit: degree)
Speed	23.5	Caller's speed (unit: km/h) Records to one decimal place.
GPS Time Stamp	12:00:00	Time data that the caller station acquires the position data
GPS Message	Osaka City/IC-7100	Caller is "DV-G": Records the GPS message Caller is "DV-A": Records the GPS-A comment

## Function Set mode

### Monitor (Default: OFF)

Function > Monitor (Monitor)

Turn the monitor function ON or OFF.

This function allows you to monitor your transmit signal in any mode other than CW.

- OFF: Turns the function OFF.
- ON: Monitors your transmit signal.

### Monitor Level (Default: 50%)

Function > Monitor Level (Monitor Level)

Adjust a transmit signal monitor level number between 0% (no audio), 1% (minimum) and 100% (maximum) for the voice synthesizer.

### Beep Level (Default: 50%)

Function > Beep Level (Beep Level)

Adjust the confirmation and band edge beep tones output level to between 0% (no beep), 1% (minimum) and 100% (maximum).

### Beep Level Limit (Default: ON)

Function > Beep Level Limit (Beep Level Limit)

Turn the confirmation and band edge beep tones output level limiting ON or OFF.

When you set this item to ON, the beep tones are adjusted by the [AF] control until rotating the control reaches to the specified level. Further rotation will not increase the volume of the beep tones.

- OFF: Beep level adjustment is not limited.
- ON: Beep level adjustment is limited with the [AF] control.

### Beep (Confirmation) (Default: ON)

Function > Beep (Confirmation) (Beep (Confirmation))

Turn the confirmation beep ON or OFF.

Set the beep output level in the "Beep Level" item as described above.

- OFF: The confirmation beep is OFF. (Silent operation)
- ON: The confirmation beep sounds each time a switch is pushed.

### Band Edge Beep (Default: ON (Default))

Function > Band Edge Beep (Band Edge Beep)

When you tune into or out of an amateur band's frequency range, you can hear a beep tone.

If you select "ON (User)" or "ON (User) & TX Limit," you can program a total of 30 band edge frequencies in the "User band Edge" item.

You can set the beep output level in the "Beep Level" item as described to the left.

- OFF: Band edge beep is OFF
- ON (Default): When you tune into or out of the default amateur band's frequency range, a beep sounds.
- ON (User): When you tune into or out of a user programmed amateur band's frequency range, a beep sounds.
- ON (User) & TX Limit: When you tune into or out of a user programmed amateur band's frequency range, a beep sounds. In addition, transmission is inhibited outside the programmed range.

### User Band Edge

Function > User Band Edge (User Band Edge)

This "User Band Edge" item appears only when "ON (User)" or "ON (User) & TX Limit" is selected in the "Band Edge Beep" item.

When you select "ON (User)" or "ON (User) & TX Limit" in the "Band Edge Beep" item, you can program a total of 30 band edge frequencies in this item.

See page 3-14 for programming details.

### RF/SQL Control (Default: RF+SQL)

Function > RF/SQL Control (RF/SQL Control)

Set the [RF/SQL] control operation.

- AUTO: [RF/SQL] functions as only an RF gain control in SSB, CW and RTTY; a squelch control in AM, FM, WFM and DV.
- SQL: [RF/SQL] functions as a squelch control.
- RF+SQL: [RF/SQL] functions not only as an RF gain control, but also as a squelch control in all modes.

## Function Set mode (Continued)

**TX Delay** (Default: All bands; OFF)

Function &gt; TX Delay (TX Delay)

Sets the transmission's timing for each operating band.

When an external device, such as a vacuum tube linear amplifier or a receiver preamplifier, is connected to the transceiver and you use the SEND line, a problem could possibly occur. If the device's transmit/receive switching time is slower than the time for the Icom transceiver, the device may not yet be ready for a transmitted signal, and could be damaged by the transceiver's RF power. If necessary to prevent damage to the external device, set an appropriate TX delay.

- OFF: The transmission delay is disabled.
- 10 to 30ms: After pushing [PTT], the transmission is delayed for the set period of time (10, 15, 20, 25 or 30 milliseconds).

**Time-Out Timer** (Default: OFF)

Function &gt; Time-Out Timer (Time-Out Timer)

To prevent accidental prolonged transmission, the transceiver has a time-out timer.

The function inhibits continuous transmissions longer than the set time period.

- OFF: Turns the function OFF.
- 3 to 30 min: The transmission is cut OFF after the set time period ends (3, 5, 10, 20 or 30 minutes).

**PTT Lock** (Default: OFF)

Function &gt; PTT Lock (PTT Lock)

Turn the PTT lock function ON and OFF.

To prevent accidental transmissions, this function disables [PTT].

**Quick SPLIT** (Default: ON)

Function &gt; SPLIT/DUP &gt; Quick SPLIT (Quick SPLIT)

Turn the Quick Split function ON or OFF.

When this item is set to ON, hold down [SPLIT] for 1 second to shift the transmit frequency from the receive frequency, according to the "SPLIT Offset" option as described to the right.

- OFF: Turns the function OFF.
- ON: Holding down [SPLIT] for 1 second quickly selects split frequency operation.

**SPLIT Offset** (Default: 0.000 MHz)

Function &gt; SPLIT/DUP &gt; SPLIT Offset (SPLIT Offset)

Set the offset\* for the quick split function.

\*The difference between transmit and receive frequencies.

The frequency offset can be set to between -9.999 MHz and +9.999 MHz in 1 kHz steps.

**SPLIT LOCK** (Default: OFF)

Function &gt; SPLIT/DUP &gt; SPLIT LOCK (SPLIT LOCK)

Turn the Split Lock function ON or OFF.

When this item is set to ON, you can use the Dial to adjust the transmit frequency while holding down [XFC], even while the Dial Lock function is enabled.

To prevent accidentally changing the receive frequency by rotating the main dial, use both the SPLIT LOCK and Dial Lock functions.

See pages 6-8 to 6-10 for split frequency operation details.

**DUP Offset**

Function &gt; SPLIT/DUP &gt; DUP Offset (DUP Offset)

Set the offset\* for duplex operation. You can set the repeater offset for each band.

\*The difference between transmit and receive frequencies.

➡ Before selecting this item, select the desired frequency band. Then, set the offset.

- The frequency offset can be set to between 0.0000 MHz and 9.9999 MHz.

▨ The default value may differ, depending on the selected frequency band and transceiver version.

**NOTE:**

- The shift direction can be set with [DUP] on M1 (M1 Menu) screen.
- You can use this setting only when the Split function is OFF.
- If the DR mode is selected before selecting this item, editing is restricted.

**One Touch Repeater** (Default: DUP-)

Function &gt; SPLIT/DUP &gt; One Touch Repeater (One Touch Repeater)

Set the one touch repeater shift direction.

- DUP-: The transmit frequency shifts down from the receive frequency by the offset amount.
- DUP+: The transmit frequency shifts up from the receive frequency by the offset amount.

## Function Set mode (Continued)

**Auto Repeater**

Function > SPLIT/DUP > Auto Repeater (Auto Repeater)

This item appears only in the Korean and U.S.A. version transceivers.

The auto **repeater** function automatically turns the duplex operation and tone encoder\* ON or OFF.

The offset and repeater tone\* are not changed by the auto repeater function. Reset these setting values, if necessary.

**For Korean versions**

- OFF: Turns the function OFF.
- ON: Turns ON the duplex operation and tone encoder\*. (Default)

**For U.S.A. version**

- OFF: Turns the function OFF.
- ON (DUP): Turns ON the duplex operation only. (Default)
- ON (DUP, TONE): Turns ON the duplex operation and tone encoder\*.

\*The tone encoder will not be turned ON in the DV mode.

**Auto Start (Default: OFF)**

Function > Tuner > Auto Start (Tuner (Auto Start))

Turn the Automatic **Antenna Tuner** function ON or OFF for an external antenna tuner (like the optional AT-180). This function is for only the HF **bands**.

- OFF: Tuning starts only when **TUNER/CALL** is pushed.
- ON: The external antenna tuner automatically starts tuning when the SWR is high, even if the tuner is turned OFF.

**PTT Start (Default: OFF)**

Function > Tuner > PTT Start (Tuner (PTT Start))

When [PTT] is pushed after the operating frequency is changed more than 1% from the last tuned frequency, the external antenna tuner (optional AH-4 or AT-180) automatically starts tuning.

- OFF: Tuning starts only when **TUNER/CALL** is pushed.
- ON : (AH-4) Automatically starts tuning when [PTT] is pushed on a new frequency, whether the external antenna tuner is ON or OFF  
(AT-180) Automatically starts tuning when [PTT] is pushed on a new frequency, only if the internal antenna tuner is ON

**[TUNER] Switch (Default: Auto)**

Function > Tuner > [TUNER] Switch ([TUNER] Switch)

Select whether or not to store the AT-180's status on each band.

When you change the operating frequency, this function will automatically select the correct AT-180's status, or you must do it manually.

- Manual: You must manually change the AT-180's status by pushing [TUNER].
- Auto: The AT-180's status memorized by the band memory is automatically selected. You can also manually change it by pushing [TUNER].

**[SPEECH/LOCK] Switch (Default: SPEECH/LOCK)**

Function > [SPEECH/LOCK] Switch ([SPEECH/LOCK] Switch)

Select the **SPEECH/LOCK** switch action.

- SPEECH/LOCK: Pushing **SPEECH/LOCK** turns ON the voice synthesizer function.  
Holding down **SPEECH/LOCK** turns the dial lock function ON or OFF.
- LOCK/SPEECH: Pushing **SPEECH/LOCK** turns the dial lock function ON or OFF.  
Holding down **SPEECH/LOCK** turns ON the voice synthesizer function.

**Lock Function (Default: MAIN DIAL)**

Function > Lock Function (Lock Function)

The dial lock function prevents frequency changes by accidental movement of the tuning dial. The lock function electronically locks the dial.

- MAIN DIAL: When Lock Function is activated, the Dial is disabled.
- PANEL: When Lock Function is activated, the panel is disabled.  
Functions except for [AF], [RF/SQL], [PWR], [SPEECH/LOCK] are inhibited.

**Memopad Numbers (Default: 5)**

Function > Memopad Numbers (Memopad Numbers)

Set the number of usable memopad channels to either 5 or 10.

See page 11-13 for details.

## Function Set mode (Continued)

**MAIN DIAL Auto TS** (Default: HIGH)

Function &gt; MAIN DIAL Auto TS (MAIN DIAL Auto TS)

Set the Auto Tuning Step function for the Dial.

When rapidly rotating the Dial, the tuning step automatically changes as selected.

There are two types of auto tuning steps: LOW (Faster) and HIGH (Fastest).

- OFF: Auto tuning step is turned OFF.
- LOW: Approximately 2 times faster.
- HIGH: Approximately 5 times faster when the tuning step is set to 1 kHz or smaller steps; approximately 2 times faster when the tuning step is set to 5 kHz or larger steps.

**MIC Up/Down Speed** (Default: Fast)

Function &gt; MIC Up/Down Speed (MIC Up/Down Speed)

Set the microphone [▲]/[▼] switches speed while holding down.

- Slow: Low speed (25 tuning steps/second)
- Fast: High speed (50 tuning steps/second)

**[NOTCH] Switch (SSB)** (Default: Auto/Manual)

Function &gt; [NOTCH] Switch (SSB) ([NOTCH] Switch (SSB))

Select the Auto, Manual or Auto/Manual notch filter to be used for SSB mode operation.

- Auto: Only the Auto notch filter can be used.
- Manual: Only the Manual notch filter can be used.
- Auto/Manual: Both the Auto and Manual notch filters can be used.

**[NOTCH] Switch (AM)** (Default: Auto/Manual)

Function &gt; [NOTCH] Switch (AM) ([NOTCH] Switch (AM))

Select the Auto, Manual or Auto/Manual notch filter to be used for AM mode operation.

- Auto: Only the Auto notch filter can be used.
- Manual: Only the Manual notch filter can be used.
- Auto/Manual: Both the Auto and Manual notch filters can be used.

**SSB/CW Sync Tuning** (Default: OFF)

Function &gt; SSB/CW Sync Tuning (SSB/CW Sync Tuning)

Turn the displayed frequency shift function ON or OFF. When this function is turned ON, the audio pitch or tones of the received signal will remain the same, even when the operating mode is changed between SSB and CW.

The amount of frequency shift may differ, depending on the CW pitch setting.

- OFF: The displayed frequency does not shift.
- ON: The displayed frequency shifts when the operating mode is changed between SSB and CW.

**CW Normal Side** (Default: LSB)

Function &gt; CW Normal Side (CW Normal Side)

Select the sideband used to receive CW in the CW normal mode between LSB and USB.

**VOICE 1st Menu** (Default: VOICE-TX)

Function &gt; VOICE 1st Menu (VOICE 1st Menu)

Select VOICE-Root or VOICE-TX as the menu that appears first after touching [VOICE] in the "M2" screen (Menu 2), when the SSB, AM, FM or DV mode is selected.

- VOICE-Root: The voice menu appears first.
- VOICE-TX: The voice SEND menu appears first.

**KEYER 1st Menu** (Default: KEYER-SEND)

Function &gt; KEYER 1st Menu (KEYER 1st Menu)

Select KEYER-Root or KEYER-SEND as the menu that appears first after touching [KEYER] in the "M2" screen (Menu 2), when in the CW mode.

- KEYER-Root: The Memory keyer menu appears first.
- KEYER-SEND: The Keyer SEND menu appears first.

**Speaker Out** (Default: ON)

Function &gt; Speaker Out (Speaker Out)

Select the speaker output function.

- OFF: The speaker does not output the received audio.  
The [ACC] socket, [USB] port, and [MIC] connector output the received audio.
- ON: The speaker outputs the received audio.

Function Set mode (Continued)

**MIC AF Out** (Default: OFF)

Function > MIC AF Out (MIC AF Out)

Select the [MIC] connector output function.

- OFF: The [MIC] connector does not output the received audio.  
When using the optional HM-151 REMOTE CONTROL MIC, select "OFF"
- ON: The [MIC] connector outputs the received audio.  
When using a speaker microphone or headset, select "OFF."

**[F-1]** (Default: SPLIT)

Function > RC MIC > [F-1] ([F-1])

The function listed below can be assigned to [F-1] on the optional HM-151 REMOTE CONTROL MIC.

- --(No function), P.AMP/ATT, AGC, NB, NR, NOTCH, RIT, AUTOTUNE/RX>CS, TS, MPAD, M-CLR, BANK, SPLIT, A/B, DUP, TONE/DSQL, COMP, TBW, METER, DR, FROM/TO (DR), SCAN, Voice TX (T1)

**[F-2]** (Default: A/B)

Function > RC MIC > [F-2] ([F-2])

The function listed below can be assigned to [F-2] on the optional HM-151 REMOTE CONTROL MIC.

- --(No function), P.AMP/ATT, AGC, NB, NR, NOTCH, RIT, AUTOTUNE/RX>CS, TS, MPAD, M-CLR, BANK, SPLIT, A/B, DUP, TONE/DSQL, COMP, TBW, METER, DR, FROM/TO (DR), SCAN, Voice TX (T1)

**Mode Select** (Default: All mode)

Function > RC MIC > Mode Select (Mode Select)

Disables the mode selection with the optional HM-151 REMOTE CONTROL MIC, to simplify operation.

- SSB, CW, RTTY, AM, FM, WFM, DV

**Power OFF (With No Controller)** (Default: ON)

Function > Power OFF (With No Controller) (Power OFF (With No Controller))

Select to automatically turn OFF the transceiver when the controller is disconnected from the transceiver.

- OFF: The transceiver power is ON.
- ON: The transceiver is automatically turned OFF.

**REF Adjust**

Function > REF Adjust (REF Adjust)

During frequency calibration, set the internal reference frequency to between 0% and 100% range.

**NOTE:**

The default setting is different for each transceiver.



## Tone Control Set mode

### **RX HPF/LPF** (Default: [----] - ----)

Tone Control > RX > (Mode) > RX HPF/LPF (RX HPF/LPF)  
(Mode: SSB/CW/RTTY/AM/FM/DV)

First select the operating mode, then set the receive audio high-pass filter to between 100 Hz and 2000 Hz in 100 Hz steps.

### **RX HPF/LPF** (Default: ---- - [----])

Tone Control > RX > (Mode) > RX HPF/LPF (RX HPF/LPF)  
(Mode: SSB/CW/RTTY/AM/FM/DV)

First select the operating mode, then set the receive audio low-pass filter to between 500 Hz and 2400 Hz in 100 Hz steps.

### **RX Bass** (Default: 0)

Tone Control > RX > (Mode) > RX Bass (RX Bass)  
(Mode: SSB/AM/FM/WFM/DV)

First select the operating mode, then set the receive audio bass level to between -5 and +5.

### **RX Treble** (Default: 0)

Tone Control > RX > (Mode) > RX Treble (RX Treble)  
(Mode: SSB/AM/FM/WFM/DV)

First select the operating mode, then set the receive audio treble level to between -5 and +5.

### **TX Bass** (Default: 0)

Tone Control > TX > (Mode) > TX Bass (TX Bass)  
(Mode: SSB/AM/FM/DV)

First select the operating mode, then set the transmit audio bass level to between -5 and +5.

### **TX Treble** (Default: 0)

Tone Control > TX > (Mode) > TX Treble (TX Treble)  
(Mode: SSB/AM/FM/DV)

First select the operating mode, then set the transmit audio treble level to between -5 and +5.

### **TBW (WIDE)** (Default: 100 - 2900)

Tone Control > TX > SSB > TBW (WIDE) (TBW (WIDE))  
(Mode: SSB)

Set the lower and higher cut-off frequencies of the transmission passband width for your wide setting.

- Lower: 100, 200, 300 or 500 Hz
- Higher: 2500, 2700, 2800 or 2900 Hz

### **TBW (MID)** (Default: 300 - 2700)

Tone Control > TX > SSB > TBW (MID) (TBW (MID))  
(Mode: SSB)

Set the lower and higher cut-off frequencies of the transmission passband width for your middle setting.

- Lower: 100, 200, 300 or 500 Hz
- Higher: 2500, 2700, 2800 or 2900 Hz

### **TBW (NAR)** (Default: 500 - 2500)

Tone Control > TX > SSB > TBW (NAR) (TBW (NAR))  
(Mode: SSB)

Set the lower and higher cut-off frequencies of the transmission passband width for your narrow setting.

- Lower: 100, 200, 300 or 500 Hz
- Higher: 2500, 2700, 2800 or 2900 Hz



## Connectors Set mode

### USB Audio SQL (Default: OFF (OPEN))

Connectors > USB Audio SQL (USB Audio SQL)

Select whether or not to output the audio from the [USB] connector on the rear panel, according to the squelch state.

The same audio signals are output from the [USB] connector and the [ACC] socket.

- OFF (OPEN): The received audio is output regardless of the squelch state.
- ON: The received audio is output depending on the squelch state (open or closed).

- The beep tones and the voice synthesizer announcements are not sent.
- The received audio output level cannot be adjusted with the [AF] control.

### ACC/USB Output Select (Default: AF)

Connectors > ACC/USB Output Select (ACC/USB Output Select)

Select whether to use the [USB] connector and the [ACC] socket for a usual received audio, or to use the IF output for [DRM (Digital Radio Mondiale)].

- AF: The received audio is output from the [ACC] socket and the [USB] connector.
- IF: The received signal is converted to an IF signal, and then output.

### ACC/USB AF Level (Default: 50%)

Connectors > ACC/USB AF Level (ACC/USB AF Level)

Enter the audio output level at the [ACC] socket and the [USB] connector to between 0% and 100%.

### ACC/USB IF Level (Default: 50%)

Connectors > ACC/USB IF Level (ACC/USB IF Level)

Set the IF output level at the [ACC] socket and the [USB] connector to between 0% and 100%.

### ACC MOD Level (Default: 50%)

Connectors > ACC MOD Level (ACC MOD Level)

Set the input modulation level at the [ACC] socket to between 0% and 100%.

### DATA MOD Level (Default: 50%)

Connectors > DATA MOD Level (DATA MOD Level)

Set the input modulation level at the [DATA] jack to between 0% and 100%.

### USB MOD Level (Default: 50%)

Connectors > USB MOD Level (USB MOD Level)

Set the input modulation level of the [USB] connector to between 0% and 100%.

### DATA OFF MOD (Default: MIC, ACC)

Connectors > DATA OFF MOD (DATA OFF MOD)

Select the desired connector(s) for data modulation input in the data OFF mode.

- MIC: Use the signals from [MIC].
- ACC: Use the signals from [ACC] (pin 11).
- MIC, ACC: Use the signals from [MIC] and [ACC] (pin 11).
- USB: Use the signals from [USB].

### DATA MOD (Default: ACC)

Connectors > DATA MOD (DATA MOD)

Select the desired connector(s) for data modulation input in the data mode.

- MIC: Use the signals from [MIC].
- ACC: Use the signals from [ACC] (pin 11).
- MIC, ACC: Use the signals from [MIC] and [ACC] (pin 11).
- USB: Use the signals from [USB].

### VOICE (Default: OFF)

Connectors > External Keypad > VOICE (External Keypad (VOICE))

Select whether or not to enable transmitting voice memory contents using the external keypad.

- OFF: The external keypad is disabled.
- ON: Transmits the desired voice memory contents in T1 to T4 during SSB, AM, FM, DV operation.

## Connectors Set mode (Continued)

**KEYER** (Default: OFF)

Connectors > External Keypad > KEYER (External Keypad (KEYER))

Select whether or not to enable transmitting keyer memory contents using the external keypad.

- OFF: The external keypad is disabled.
- ON: Transmits the desired keyer memory contents in M1 to M4 during CW mode operation.

**RTTY** (Default: OFF)

Connectors > External Keypad > RTTY (External Keypad (RTTY))

Select whether or not to enable transmitting RTTY memory contents using the external keypad.

- OFF: The external keypad is disabled.
- ON: Transmits the desired RTTY memory contents in RT1 to RT4 during RTTY mode operation.

**CI-V Baud Rate** (Default: Auto)

Connectors > CI-V > CI-V Baud Rate (CI-V Baud Rate)

Set the **CI-V** data transfer speed to 300, 1200, 4800, 9600, 19200 bps or Auto.

When "Auto" is selected, the baud rate is automatically set according to the data rate of the controller.

**CI-V Address** (Default: 88h)

Connectors > CI-V > CI-V Address (CI-V Address)

To distinguish equipment, each CI-V transceiver has its own Icom standard address in hexadecimal code.

The IC-7100's default address is 88h.

When 2 or more IC-7100s are controlled through a PC at the same time, set a different address for each device between 01h and DFh (hexadecimal).

**CI-V Transceive** (Default: ON)

Connectors > CI-V > CI-V Transceive (CI-V Transceive)

Turn the CI-V Transceive function ON or OFF.

- OFF: Turns the function OFF.
- ON: When you change a setting on the transceiver, the same change is automatically set on other connected transceivers or receivers, and vice versa.

**USB2 Function** (Default: OFF)

Connectors > USB2/DATA1 Function > USB2 Function (USB2 Function)

Two COM port numbers are assigned to the [USB] connector. One of them is used for cloning and CI-V operation (USB1).

Select the use of the other COM port (USB2).

- OFF: Does not use the COM port (USB2).
- RTTY: Decode used for RTTY decoded signal output.
- DV Data: Used for low-speed data input and output.
  - If DATA1 Function is set to "GPS," and GPS Out is set to "DATA1→USB2," the COM port (USB2) will be used for low-speed data input and GPS data output.

**DATA1 Function** (Default: GPS)

Connectors > USB2/DATA1 Function > DATA1 Function (DATA1 Function)

Select the use of the [DATA1] jack.

- OFF: Does not use the [DATA1] jack.
- RTTY: Decode used for RTTY decoded signal output.
- DV Data: Used for low-speed data input and output.
- GPS: Used for the GPS receiver connection for position data input.

**NOTE:**

You cannot set "DV Data" to both "USB2 Function" and "DATA1 Function."

If you select "DV Data" for one of them when "DV Data" is set to the other one, the previously set item will be to "OFF."

**GPS Out** (Default: OFF)

Connectors > USB2/DATA1 Function > GPS Out (GPS Out)

Select whether or not to output the data to the COM port (USB2) when data is input from a GPS receiver through the [DATA1] jack.

**NOTE:**

You can use this function only when "OFF" or "DV Data" is selected as the "USB2 Function" option, and "GPS" is selected as the "DATA1 Function" option.

- OFF: Turns OFF the function.
- DATA1→USB2: Outputs the GPS data to the COM port (USB2).

Connectors Set mode (Continued)

**DV Data/GPS Out Baud** (Default: 4800)

Connectors > USB2/DATA1 Function > DV Data/GPS Out Baud (DV Data/GPS Out Baud)

Set the DV or GPS data transfer speed to 4800 or 9600 bps.

**RTTY Decode Baud** (Default: 9600)

Connectors > USB2/DATA1 Function > RTTY Decode Baud (RTTY Decode Baud)

Set the RTTY decode monitor speed to 300, 1200, 4800, 9600 or 19200 bps.

**VSEND Select** (Default: VHF/UHF)

Connectors > VSEND Select (VSEND Select)

Select the **band** to use for the [ACC] socket's pin 7 (VSEND usage) and pin 3 (HSEND usage).

- OFF: VSEND is not used.  
HSEND is used for all bands.
- UHF: VSEND is used for the 430 MHz band.  
HSEND is used for the HF/50 MHz and 144 MHz bands.
- VHF/UHF: VSEND is used for the 144 MHz and 430 MHz bands.  
HSEND is used for the HF/50 MHz bands.

**9600bps Mode** (Default: OFF)

Connectors > 9600bps Mode (9600bps Mode)

Select whether to allow data transmission at 9600 bps, or not on the [DATA2] socket.

- OFF: Disables data transmission at 9600 bps on the [DATA2] socket. This is used for regular audio or slower data transmission only.
- ON: Enables data transmission at 9600 bps on the [DATA2] socket.

## Display Set mode

### Display Contrast (Default: 50%)

Display > LCD Contrast (LCD Contrast)

Set the display contrast level to between 0% and 100%.

### LCD Backlight (Default: 50%)

Display > LCD Backlight (LCD Backlight)

Set the LCD backlight brightness to between 0% and 100%.

### Key Backlight (Default: 50%)

Display > Key Backlight (Key Backlight)

Set the key backlight brightness to between 0% and 100%.

### Meter Peak Hold (Default: ON)

Display > Meter Peak Hold (Meter Peak Hold)

Turn the Meter Peak Hold function ON or OFF. This function displays the peak level of a received signal strength or the output power for approximately 0.5 seconds.

### BW Popup (PBT) (Default: ON)

Display > BW Popup (PBT) (BW Popup (PBT))

Select whether or not to display the **PBT** shift value while rotating the TWIN-PBT control.

- OFF: Turns the function OFF.
- ON: Displays the PBT shift value.

### BW Popup (FIL) (Default: ON)

Display > BW Popup (FIL) (BW Popup (FIL))

Select whether or not to display the IF **filter** width and shift value when the IF filter is switched by touching the filter icon.

- OFF: Turns the function OFF.
- ON: Displays the IF filter width and shift value.

### RX Call Sign Display (Default: Auto)

Display > RX Call Sign Display (RX Call Sign Display)

Select whether or not to display the **call sign** of the caller station when a call is received.

- OFF: Does not display the caller station's call sign.
- Auto: The caller station's call sign automatically scrolls once, and then disappears.
- Auto (RX Hold): The caller station's call sign automatically scrolls once, and then remains on the display until the signal disappears.

#### NOTE:

When "Auto" or "Auto (RX Hold)" is selected, and if the call sign and name of the caller station is programmed in your memory, the programmed name is displayed after showing the call sign.

### RX Message Display (Default: Auto)

Display > RX Message Display (RX Message Display)

Select whether or not to display and scroll a received message.

- OFF: Does not display the message. To check the message, touch [CD] on the "D-1" screen (Menu D1) to display the call record.
- Auto: Automatically displays and scrolls the message. The message is automatically displayed every 30 seconds until their signal disappears.

#### NOTE:

When "Auto" or "Auto (RX Hold)" is selected in RX Call Sign Display, the message is displayed after displaying the caller station's call sign.

### Reply Position Display (Default: ON)

Display > Reply Position Display (Reply Position Display)

Select whether or not to display the caller's position data when the data is included in the Auto Reply signal.

- OFF: Does not display the caller's position data.
- ON: Automatically displays the caller's position data.

## Display Set mode (Continued)

**TX Call Sign Display (Default: Your Call Sign)**

Display &gt; TX Call Sign Display (TX Call Sign Display)

Select whether or not to display your own or the destination station's **call sign** while transmitting.

- OFF: Does not display the call sign.
- Your Call Sign: Displays and scrolls the destination's call sign.  
When the called station's call sign and name are programmed into memory, the transceiver shows the name after the call sign in any DV mode except for the DR mode.
- My Call Sign: Displays and scrolls your own call sign.

**Scroll Speed (Default: Fast)**

Display &gt; Scroll Speed (Scroll Speed)

This item sets the scrolling speed of the message, call sign, or other text, that is displayed on the transceiver's LCD.

- Slow: The speed is set to slow.
- Fast: The speed is set to fast.

**VOICE TX Name Display (Default: ON)**

Display &gt; VOICE TX Name Display (VOICE TX Name Display)

Select whether or not to display the voice TX memory name on the "Voice TX" screen.

- OFF: Does not display the voice TX memory name.
  - ON: Displays voice TX memory name.
- Regardless of this setting, the voice TX memory name is displayed on the "Voice TX RECORD" screen.

**KEYER Memory Display (Default: ON)**

Display &gt; KEYER Memory Display (KEYER Memory Display)

Select whether or not to display the keyer memory contents on the "Keyer Send" screen.

- OFF: Does not display the keyer memory contents.
- OFF: Displays keyer memory contents.

**Opening Message (Default: ON)**

Display &gt; Opening Message (Opening Message)

Select whether or not display the opening message at power ON.

- OFF: Opening message display is skipped.
- ON: Icom logo, MY call sign and the product model ("IC-7100")\* are displayed at power ON.

**Power ON Check (Default: ON)**

Display &gt; Power ON Check (Power ON Check)

Select whether or not to display the RF Power, RIT, Auto Power OFF condition when the transceiver is activated.

When the RIT or Auto Power OFF is set to OFF, no display is shown.

- OFF: Does not display the RF Power, RIT, Auto Power OFF condition.
- ON: Displays the RF Power, RIT, Auto Power OFF condition.

**Display Language (Default: English)**

Display &gt; Display Language (Display Language)

**This item will appear only when "Japanese" is selected in System Language. See page 17-29 "Choose your language carefully" about setting cautions.**

Set the screen display language type in the "TO" or "FROM" screen in the DR mode or the Set mode screen to English or Japanese.

**System Language (Default: English)**

Display &gt; System Language (System Language)

Set the system language of the transceiver to English or Japanese.

- English: The system language of the transceiver is English.
  - Only alphabetical characters (A to Z, a to z, 0 to 9) and symbols (! " # \$ % & ' ( ) \* + , - . / : ; < = > ? @ [ \ ] ^ \_ ` { | } ~) can be displayed.
  - If Japanese characters (Kanji, Hiragana and Katakana) are included, the LCD shows "=" or "\_" instead of that character. In this case, you can only delete "=" or "\_" in the transceiver's edit mode.
  - The Display Language item will be hidden.
- Japanese: The system language of the transceiver is Japanese.  
Kanji, Hiragana and Katakana characters, and the 2-bytes symbols can be displayed on the LCD.  
To display such characters in the "TO" or "FROM" screen in the DR mode or the Set mode screen, Display Language must be set to "Japanese."

### Display Set mode (Continued)

#### Choose your language carefully

When the system language of the transceiver is set to Japanese, the IC-7100 has the capability to display both English and Japanese characters. HOWEVER, if you select Japanese as the display language (p. 17-28), all menu items throughout the IC-7100 system will be displayed in only Japanese characters. There will be no English item names. Unless you are fluent in reading Japanese characters, use this feature with extreme caution.

If you change the IC-7100's language to Japanese, and can't understand the menu system in the new setting, you will have to change the language back to English in "Display Language" or "System Language" (this item), or by doing a partial reset of the IC-7100 CPU. A partial reset will not clear your **call sign** databases.

To do a partial reset of the CPU, do the following steps:

- ① Push SET(C) to enter the Set mode.
- ② Touch the "Partial Reset" item of the "Others" Set mode.  
Others > Reset > **Partial Reset**
  - If the specified item is not displayed, touch [▲] or [▼](D) one or more times to select the page.
- ③ When the dialog appears, touch "YES."
  - The transceiver displays "PARTIAL RESET," then the partial reset is completed.

## Time Set Set mode

### DATE

Time Set > Date/Time > DATE (DATE)

Manually set the date.

### TIME

Time Set > Date/Time > TIME (TIME)

Manually set the time that is displayed on the right hand corner of the screen to between 0:00 and 23:59.

The time is displayed in the 24 hour format.

### GPS Time correct (Default: Auto)

Time Set > GPS Time Correct (GPS Time Correct)

Select whether or not the time data is automatically corrected by a received GPS sentence.

- OFF: The time data is not automatically corrected.
- Auto: The time data is automatically corrected.

### UTC Offset (Default: ±0:00)

Time Set > UTC Offset (UTC Offset)

Set a time difference between **UTC** (Universal Time Coordinated) and the local time to between -14:00 and +14:00 in 00:05 steps.

### Clock Display (Default: Local)

Time Set > Clock Display (Clock Display)

Set a desired clock display mode.

- Local: Displays the local time.
- UTC: Displays the UTC (Universal Time Coordinated).

### Auto Power OFF (Default: OFF)

Time Set > Auto Power OFF (Auto Power OFF)

This function automatically turns OFF the power after no operation has not been performed for the preprogrammed time.

The "Auto Power OFF" pops up in 10 seconds before the transceiver automatically turns OFF, and a beep sounds. If an operation is made within the 10 seconds, the timer restarts.

- OFF: Turns the function OFF.
- 30 to 120 min: Select a desired Auto Power OFF time between 30, 60, 90 and 120 minutes. The power automatically turns OFF after no operation is made for the specified time period.

#### NOTE:

The auto power OFF timer activates each time the transceiver is turned ON. To deactivate the timer, select OFF.



## Others Set mode

### Version

---

Others > Information > Version (VERSION)

Shows the transceiver firmware's version number.

### Clone Mode

---

Others > Clone > Clone Mode

Select to read or write the CS-7100 data from or to the PC, and/or to receive data from a Master transceiver.

See page 19-5 for details.

### Clone Master Mode

---

Others > Clone > Clone Master Mode

Select to write your IC-7100 (Master) data to another IC-7100 (Sub).

See page 19-5 for details.

### Touch Screen Calibration

---

Others > Touch Screen Calibration

Touch to adjust the touch screen.

See page 19-10 for details.

### Partial Reset

---

Others > Reset > Partial Reset

A Partial reset resets operating settings to their default values (VFO frequency, VFO settings, menu contents) without clearing the items below:

See page 19-3 for details.

### All Reset

---

Others > Reset > All Reset

Reset the CPU, if the internal CPU malfunctions due to static electricity, and so on. All reset clears all programming and returns all settings to their factory defaults (including the programmed data you purchased).

Therefore, after the All resetting, you cannot use the transceiver in the DR mode until reprogramming the repeater list.

See page 19-4 for details.

---

#### ✓ *Recommend!*

Before the All resetting, we recommend you save the programmed data you purchased onto an SD card.

See page 13-6 for details.

---

# Section 18 DATA COMMUNICATION

---

<b>Connections.....</b>	<b>18-2</b>
◇ When connecting to [DATA2].....	18-2
◇ When connecting to [ACC].....	18-2
◇ When connecting to [MIC].....	18-2
<b>Packet (AFSK) operation.....</b>	<b>18-3</b>
<b>Setting the data transmission speed.....</b>	<b>18-4</b>
<b>Adjusting the TNC output level .....</b>	<b>18-5</b>
◇ Using a level meter or synchroscope .....	18-5
◇ Not using a measuring device.....	18-5

## Connections

### ◇ When connecting to [DATA2]

#### • When using a PC application

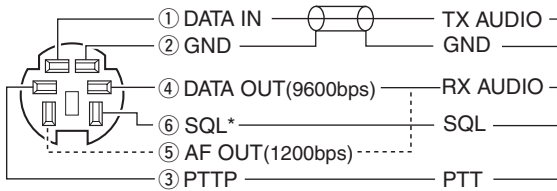

Connect to the serial port, parallel port, speaker jack, microphone jack and line IN/OUT jack and so on. See the instruction manual of the application for details.

\* When connecting the squelch line, consult the necessary manual (TNC, etc.).

#### • When using a TNC

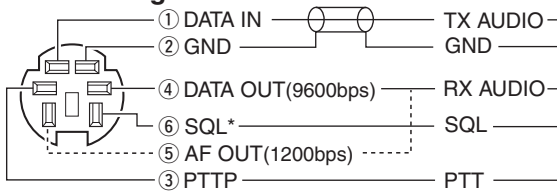

Rear panel view

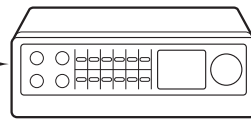

TNC

RS-232C

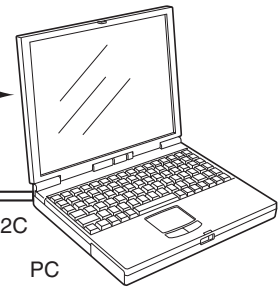

PC

### ◇ When connecting to [ACC]

#### • When using a PC application

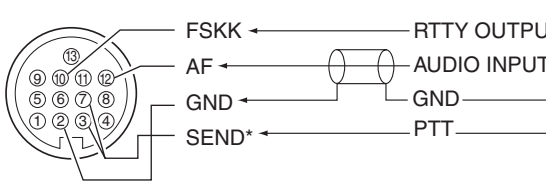

Connect to the serial port, parallel port, speaker jack, microphone jack or line IN/OUT jack and so on. See the instruction manual of the application for details.

\*③ HF/50 MHz: HSEND  
⑦ 144/430 MHz: VSEND

#### • When using a TNC

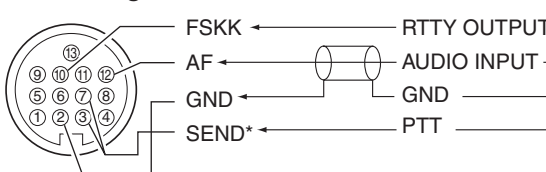

Rear panel view

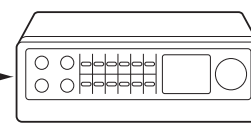

TNC

RS-232C

PC

• Select pin 7 (VSEND) and pin 3 (HSEND) output usage in the Set mode. (p. 17-26)

### ◇ When connecting to [MIC]

#### • When using a PC application

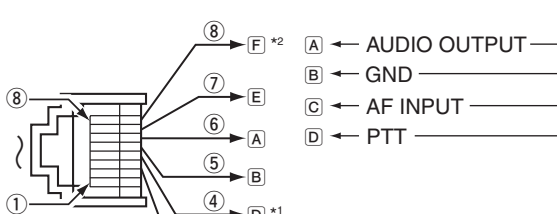

Rear panel view

Connect to the serial port, parallel port, speaker jack, microphone jack and line IN/OUT jack, etc. See the instruction manual of the application for details.

\*1 When using the **VOX** function, no connection is needed. Refer to the instruction manual of the external equipment.

\*2 When connecting the squelch line, consult the necessary manual.

\*3 Using this terminal, the "MIC AF Out" item is set to "ON" in "Function" Set mode. (p. 17-22)

#### • When using a TNC

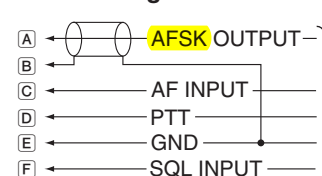

TNC

RS-232C

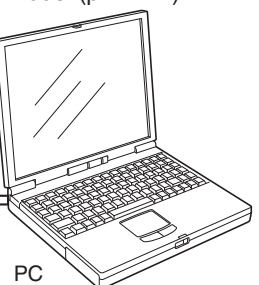

PC

## Packet (AFSK) operation

Before operating packet (AFSK), be sure to consult the operating manual that came with your TNC.

- ① Connect the TNC and PC. (p. 18-2)
- ② Select the desired band. (p. 3-6)
- ③ Select the Data mode of SSB, AM or FM. (p. 3-17)
- ④ Rotate the Dial to tune the desired signal and decode it correctly by using the tuning indicator of the TNC or software.
  - When a signal is received, the S-meter is displayed according to the signal strength level.
  - In the SSB data mode, the ¼ tuning function can be used for critical tuning. (p. 3-10)
- ⑤ Operate the PC (software) or TNC to transmit.
  - When operating in the SSB data mode, adjust the TNC output level so that the ALC meter reading doesn't go outside the ALC zone.

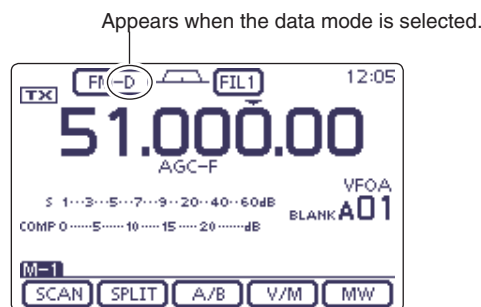

### Frequency display during AFSK operation

When operating AFSK in the SSB mode, the displayed frequency is the signal's carrier point.

#### • Tone-pair example

HF band/LSB data mode  
 Mark frequency: 2125 Hz  
 Shift frequency: 200 Hz

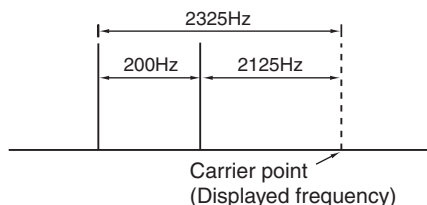

**NOTE:** When the data mode is selected, the audio input from the [MIC] connector is automatically cut, and the audio input from the [ACC] socket is used as the default.\*1

Also, when the data mode is selected, the fixed settings listed below are automatically selected:

- Speech compressor: OFF
- Transmit bandwidth: MID\*2
- Tx tone (Bass): 0
- Tx tone (Treble): 0

\*1 Select the connector(s) for the desired modulation to input in the "DATA MOD" item of the Set mode. (p. 17-24)

\*2 Fixed to the default value of 300 Hz to 2700 Hz.

## Setting the data transmission speed

In the FM data mode, the data transmission speed can be set to 9600 bps only when the data is output from pin 3 of the [DATA2] socket.

- ① Push **SET**(**C**) to enter the Set mode.
- ② Touch the "9600bps Mode" item of the "Connectors" Set mode.  
 (Connectors > **9600bps Mode**)
  - If the specified item is not displayed, touch [**▲**] or [**▼**](**D**) one or more times to select the page.
- ③ Touch "ON."
  - ON: 9600 bps data speed
  - OFF: Disables data transmission at 9600 bps. This is used for only regular audio or slower data transmission.
- ④ Push **SET**(**C**) to exit the Set mode.

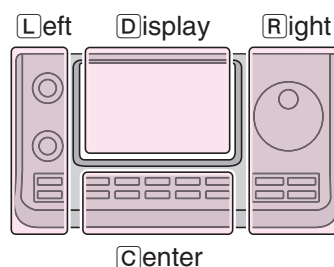

The **L**, **R**, **C** or **D** in the instructions indicate the part of the controller.

- L**: Left side
- R**: Right side
- C**: Center bottom
- D**: Display (Touch screen)

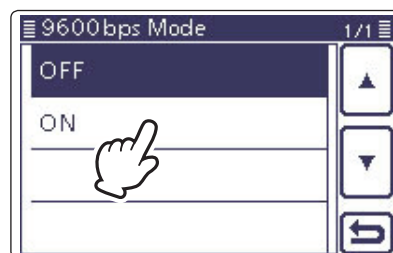

## Adjusting the TNC output level

When the data transmission speed is set to 9600 bps, the data signal coming from the TNC is applied exclusively to the internal limiter circuitry to automatically maintain **band** width.

**NEVER** apply data levels from the TNC of over 0.6 Vpp. Otherwise the transceiver will not be able to maintain the band width, and your transmitted signal may possibly interfere with other stations.

### ◇ Using a level meter or synchroscope

When using a level meter or synchroscope, adjust the TX audio output level (DATA IN level) from the TNC as follows.

0.4 Vpp (0.2 Vrms): recommended level  
0.2–0.5 Vpp (0.1–0.25 Vrms): acceptable level

### ◇ Not using a measuring device

- ① Connect the TNC to the transceiver. (p. 18-2)
- ② Enter a test mode (“CAL,” and so on) on the TNC, then transmit some test data.
- ③ If the transceiver fails to transmit the test data, or transmits sporadically, (TX/RX indicator doesn’t light or it flashes):
  - Decrease the TNC output level until the transmit indicator lights continuously.
 If transmission is not successful, even though the TX indicator lights continuously, increase the TNC output level.

#### INFORMATION!

When “RTTY” is selected as the “USB2/DATA1 Function” item option in the Set mode (SET(C)) > Connectors > **USB2/DATA1 Function**, the USB port sends an RTTY decode signal. In this case, you must connect a USB cable\* between the transceiver’s USB port on the rear panel and the PC. (p. 17-25)

\*Purchase separately

- The USB driver and the installation guide can be downloaded from our website.

URL: <http://www.icom.co.jp/world/index.html>

# Section 19 MAINTENANCE

---

<b>Cleaning .....</b>	<b>19-2</b>
<b>Replacing the fuses.....</b>	<b>19-2</b>
◇ Circuitry fuse replacement .....	19-2
◇ DC power cable fuse replacement .....	19-2
<b>Resetting the CPU .....</b>	<b>19-3</b>
◇ Partial reset .....	19-3
◇ All reset .....	19-4
<b>Data cloning .....</b>	<b>19-5</b>
◇ Cloning between transceivers using a mini plug cable.....	19-5
◇ Cloning using a cloning software.....	19-6
◇ Initial setup using an SD card.....	19-7
<b>Importing the repeater list in a CSV format file .....</b>	<b>19-8</b>
<b>Programming and Exporting the repeater list in a CSV format file.....</b>	<b>19-9</b>
<b>Touch screen calibration function .....</b>	<b>19-10</b>
<b>Dial tuning tension adjustment .....</b>	<b>19-10</b>
<b>Protection function.....</b>	<b>19-10</b>
<b>External keypad connections.....</b>	<b>19-11</b>
<b>Band voltage modification.....</b>	<b>19-11</b>
<b>Troubleshooting.....</b>	<b>19-12</b>
◇ Transceiver power .....	19-12
◇ Transmit and receive .....	19-12
◇ Display.....	19-13
◇ Scanning .....	19-13
◇ While operating D-STAR .....	19-14



## Cleaning



If the transceiver becomes dusty or dirty, wipe it clean with a dry, soft cloth.



**DO NOT** use harsh solvents such as benzene or alcohol when cleaning, as they will damage the transceiver surfaces.

## Replacing the fuses

If a fuse blows, and the transceiver stops functioning, find the source of the problem, and repair it. Then replace the damaged fuse with a new, adequately rated fuse.

**WARNING!** Turn OFF the power and disconnect the DC power cable from the transceiver before performing any work on the transceiver. Otherwise, there is danger of electric shock, equipment damage and/or fire injury.

### ◇ Circuitry fuse replacement

- ① Remove the 9 screws, then remove the top cover.
- ② Replace the circuitry fuse as shown to the right.

**CAUTION:** USE needle-nose pliers when removing the fuse, and pull it straight. If the fuse is forcibly pulled, your fingers may be injured or the fuse holder may be damaged.

- ③ Replace the top cover and screws to their original positions.

Fuses are installed in the DC power cable and in the internal PA unit.

- DC power cable fuses ..... ATC 30 A
- PA unit fuse ..... ATC 5 A

**WARNING!** USE only the applicable fuse. If an inapplicable fuse is used, a fire may be caused or damage the transceiver.

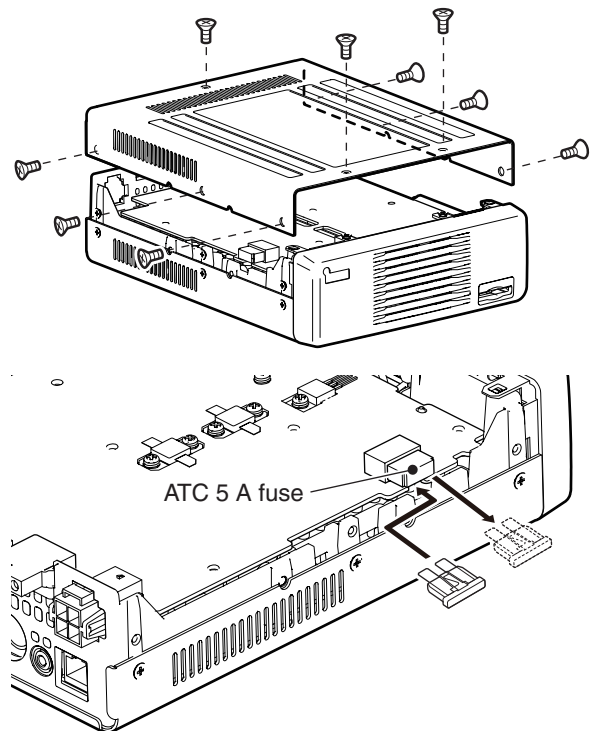

### ◇ DC power cable fuse replacement

- ① Refer the figure described to the right, then open the fuse holder of the DC power cable.
- ② Replace the damaged fuse with a new rated one.
- ③ Close the fuse holder.

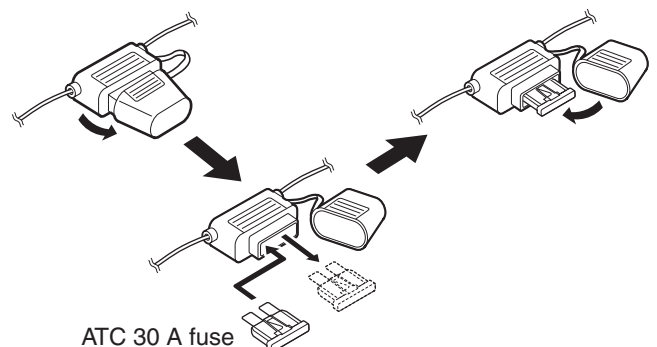

## Resetting the CPU

If you want to reset the operating parameters to their default values (VFO frequency, VFO settings, menu group's contents) without clearing certain data, a partial reset can be performed as described below.

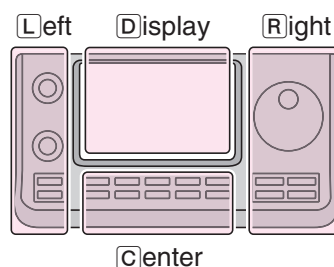

The **L**, **R**, **C** or **D** in the instructions indicate the part of the controller.

- L**: Left side
- R**: Right side
- C**: Center bottom
- D**: Display (Touch screen)

### ◇ Partial reset

- ① Push **SET**(**C**) to enter the Set mode.
- ② Touch the "Reset" item of the "Others" Set mode.  
(Others > **Reset**)
  - If the specified item is not displayed, touch [**▲**] or [**▼**](**D**) one or more times to select the page.
- ③ Touch "Partial Reset."

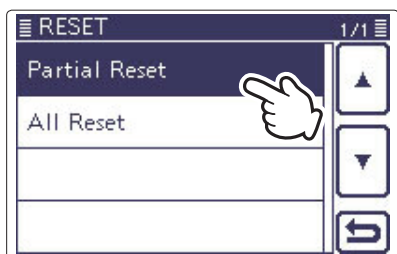

- ④ When the dialogue appears, touch "YES."

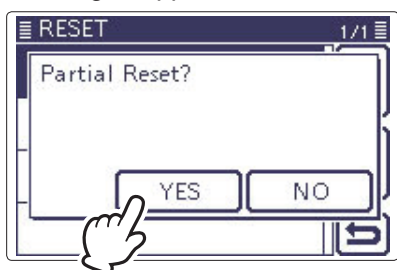

- ⑤ The transceiver displays "PARTIAL RESET," then the partial reset is completed.

### After performing the partial reset

A Partial reset resets operating settings to their default values (VFO frequency, VFO settings, menu contents) without clearing the items listed below:

- Memory channel contents (Section 4)
- Repeater list (p. 9-28)
- **Call sign** memories (p. 9-45)
- TX Message data (p. 9-2)
- GPS Memory contents (p. 10-7)
- GPS Message data (p. 10-17)
- Programmed user band edge frequencies (p. 3-14)
- Memory keyer contents (p. 4-6)
- **DTMF** memories (p. 6-17)
- RTTY memories (p. 4-18)
- REF Adj (Reference frequency) setting (p. 17-22)

Resetting the CPU (Continued)

◇ All reset

✓ **Recommended!**

After an All reset, you cannot use the transceiver in the DR mode because the repeater list will be cleared. So we recommend you save the programmed data onto an SD card, or to your PC using the optional cloning software (CS-7100) before doing an All reset. After the All reset is finished, load or write the saved data into your transceiver.

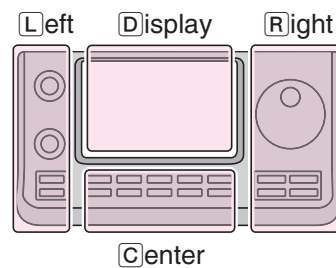

The L, R, C or D in the instructions indicate the part of the controller.

- L: Left side
- R: Right side
- C: Center bottom
- D: Display (Touch screen)

- ① Push **SET**(C) to enter the Set mode.
- ② Touch the "Reset" item of the "Others" Set mode.  
(Others > **Reset**)
  - If the specified item is not displayed, touch [▲] or [▼](D) one or more times to select the page.
- ③ Touch "All Reset."
- ④ When the dialogue appears, touch "NEXT."

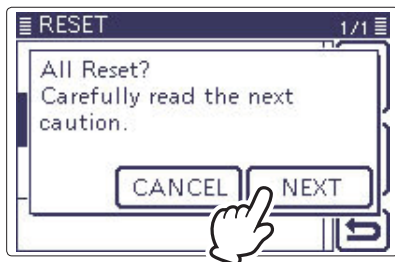

- ⑤ After reading the displayed message, touch "YES" to perform the All reset.

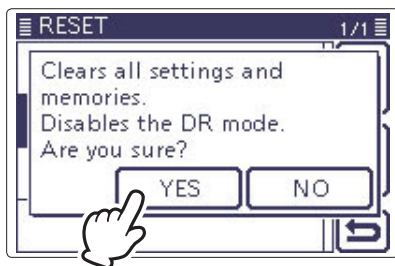

- ⑥ The transceiver displays "ALL RESET," then the All reset is completed.

**After performing the All reset**

All reset clears all programming and returns all settings to their factory defaults. Therefore, the repeater list, Memory channel contents, filter setting and so on will be cleared, so you will need to reprogram your operating settings.

**When you cannot enter the Set mode**

If a touch screen operation error or an unexpected operation occurs, you cannot enter the Set mode. In this case, perform the All reset as described below:

- ➔ While holding down **SET**(C), **SPEECH**(R) and **MPAD**(R), push **[PWR]**(L).

## Data cloning

The IC-7100 has data cloning capability. This function is useful when you want to copy all of the programmed contents from one IC-7100 to another.

You can clone using an SD card, optional cloning software (CS-7100) or a mini plug cable (purchase separately). See page 13-15 for an SD card cloning.

### ◇ Cloning between transceivers using a mini plug cable

- 1 Connect a mini plug cable to the [REMOTE] jack of the master and sub transceivers.

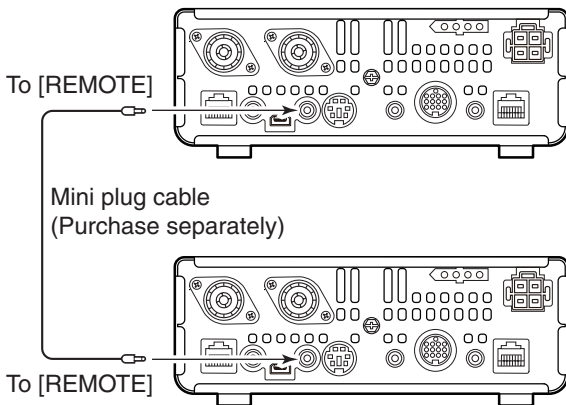

- 2 Push [PWR] (L) to turn ON the power, and then touch the "Clone" item of the "Others" Set mode. (SET) (C) > Others > **Clone**
- 3 Operate the master transceiver and sub transceiver as described below.

#### Master transceiver's operation:

Touch the "Clone Master Mode." When the dialogue "Go to the Clone Master Mode?" appears, touch "YES."

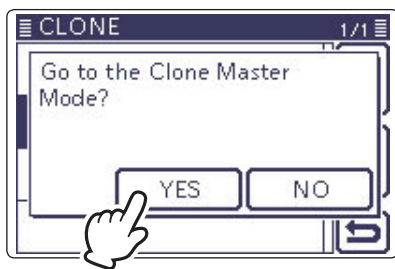

#### Sub transceiver's operation:

Touch the "Clone Mode." When the dialogue "Go to the Clone Mode?" appears, touch "YES."

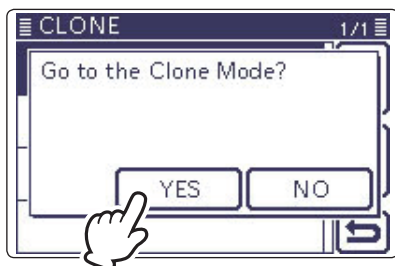

- 4 Touch "OUT" on the master transceiver to start cloning.

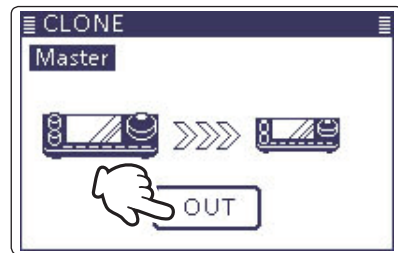

While cloning, the screen as show below is displayed.

#### Master transceiver's screen:

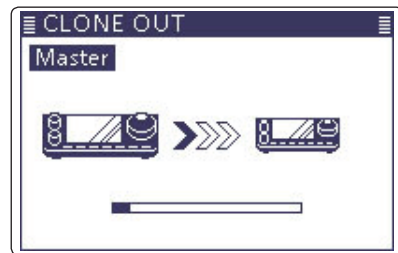

#### Sub transceiver's screen:

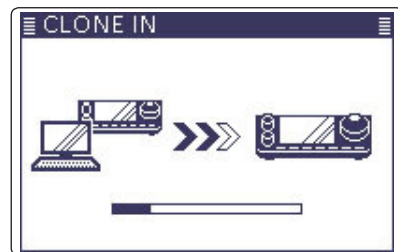

- 5 When cloning is finished, turn power OFF, then ON again to exit the cloning mode.

- "CLONE END" appears automatically on the sub transceiver's display after the cloning is completed.

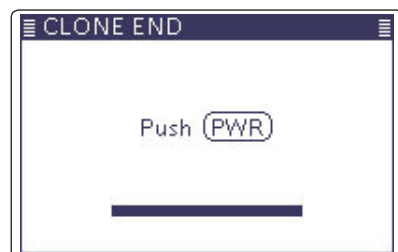

## Data cloning (Continued)



## ◇ Cloning using a cloning software

The optional CS-7100 CLONING SOFTWARE is also available to clone/edit contents with a PC using ICF format files.

The programmed data can be write to the transceiver using an SD card or a PC.

This section describes how to write the programmed data to the transceiver using an SD card.

If you want to write the programmed data into the transceiver using a PC, see the CS-7100 instruction manual for details.

- ① Save the IC-7100's setting data onto an SD card. (p. 13-6)  
(**SET**)(**C**) > SD Card > **Save Setting**)
- ② Start-up the Windows that the CS-7100 is installed.
- ③ Insert the SD card in the PC.
  - Insert the SD card into the SD card slot of the PC or the SD card reader.
- ④ Double-click the CS-7100 shortcut icon on the desktop to start the software.
  - After starting up, "Initial Setup" appears the first time.
  - To make the initial setup using the saved data on the card, follow the steps as described in "Initial setup using an SD card." (p. 19-7)
- ⑤ Click " " on the tool bar, or "Open..." in the File menu to show the data file selection screen. Select the ICF file, saved in step ①, as described above.
- ⑥ Set the desired settings in the CS-7100.
  - Please refer to the Help file of the cloning software for assistance with the functions or settings.
- ⑦ Click " " on the tool bar, or "Save As..." in the File menu to save the settings in an "icf" file format in a [Setting] folder on the card.
- ⑧ Insert the SD card that includes the ICF file into the slot of the transceiver.
- ⑨ Load the file to complete the cloning.  
(**SET**)(**C**) > SD Card > **Load Setting**)

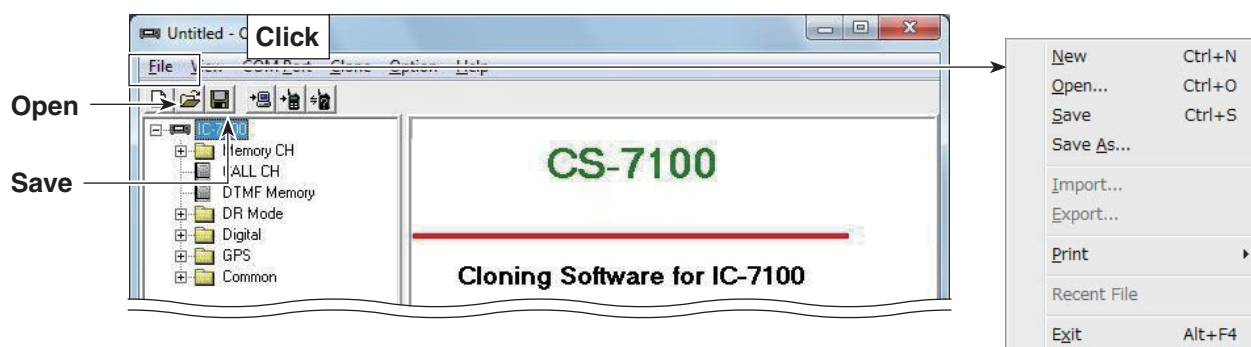

Data cloning (Continued)

◇ Initial setup using an SD card

After starting up the first time, “Initial Setup” appears.

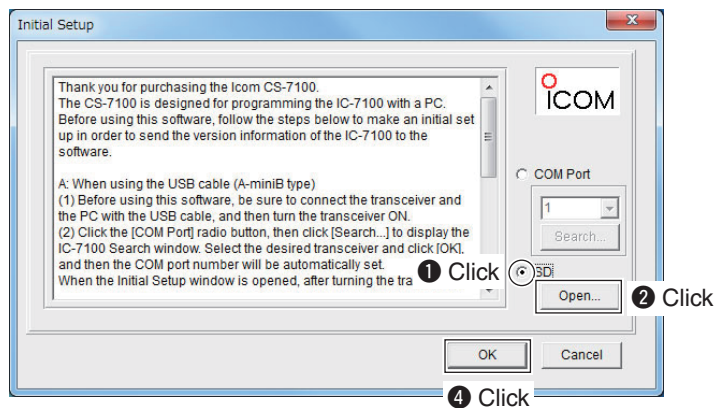

To make the initial setup using the saved data in the card, follow the steps below.

- ① Click the [SD] radio button.
- ② Click [Open...] to show the data file selection screen.
- ③ Select the “icf” file format stored in a [Setting] folder on the card.
- ④ Click [OK] to read the selected file, and open the cloning screen.  
Set the desired settings in the CS-7100.

The initial setup is required only once. After completing, the top screen appears when starting up the CS-7100.

## Importing the repeater list in a CSV format file

Please read this section before importing the repeater list in a Comma Separated Values (CSV) format file to write the repeater information to the transceiver.

When the supplied USB cable is used to clone:  
The setting contents, except the repeater list, can be retained by doing the following procedures.

### 1. Reading the data from the transceiver

➔ Click , or select “Read <- TR” in the [Clone] menu to start reading the data from the transceiver.

▨ Before importing, make a backup file of all the transceiver’s data onto your PC in case of data loss.

### 2. Repeater list import

① Select the “Repeater List” folder or each repeater group on the tree view screen of the CS-7100.

② Click “Import” in the [File] menu, and then click “All...”.

• The repeater information in a CSV file will be imported, and sorted into all groups, according to the group number.

▨ **NOTE:** When “Group...” is selected, all repeater information in the file will be imported into the repeater group, selected in step ①.

▨ If you select the “Repeater List” folder in step ①, “Group...” cannot be selected.

③ The [Open] screen appears.

Select the CSV file, saved in “Updating the repeater list” described on page 13-12, and then click [Open].

④ The “Import from the file” dialog appears, and then click [OK].

⑤ The “Keep ‘USE(FROM)’ setting in Repeater List?” dialog box appears, and then click [Yes] or [No] to start importing.

• **Yes:** If the repeater **call sign** in your original repeater group is in the CSV file format, the original “USE(FROM)” settings will be kept when importing.

• **No:** Even if the repeater call sign in your original repeater group is in the CSV file format, the original “USE(FROM)” setting will be replaced when importing.

⑥ The repeater information of the repeater list is read to the CS-7100.

• Import is complete.

▨ • See the CS-7100 instruction manual (“■ Select the Clone Mode”) for details about how to write the imported repeater list to the transceiver.

▨ • See page 19-9 for details about how to program or export the repeater list.

<Tree view screen of the CS-7100>

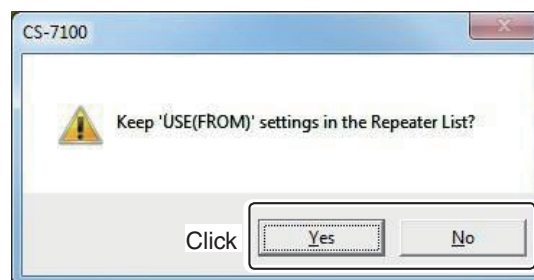
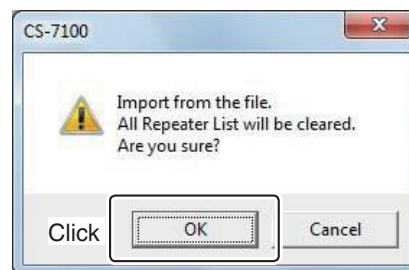
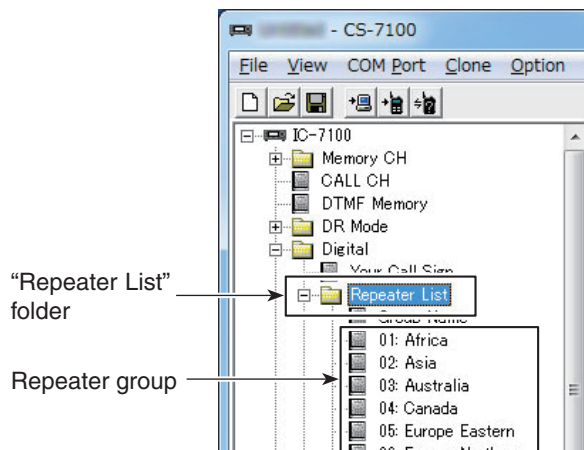

#### About the “USE(FROM)” setting

Select whether or not the repeater can be selected as an access repeater (FROM), when you rotate the Dial.

If “NO” is selected, the repeater does not appear in the “FROM” selection, and is skipped during a DR mode scan.



## Programming and Exporting the repeater list in a CSV format file

Please read this section before programming and exporting the repeater list in a Comma Separated Values (CSV) format file.

### 1. Programming the Repeater list

- ① Select the desired repeater group in the “Repeater List” folder on the tree view screen of the CS-7100.
- ② Program each item of the repeater list, using the CS-7100.
  - See the Help file of the CS-7100 for assistance.

### 2. Exporting the Repeater list

- ① Select the “Repeater List” folder or each repeater group on the tree view screen.
- ② Click “Export” in the [File] menu, and then click “Group...” or “All...”.

**NOTE:** If you select the “Repeater List” folder in step ①, “Group...” cannot be selected.

- **Group...** : Exports repeater information programmed in only the selected group.
  - **All...** : Exports repeater information programmed in all groups.
- ③ When the “Save as” window appears, save the data in a CSV format using a individual file name. Then save it in a CSV format file to a folder on your PC, and the exportation is completed.

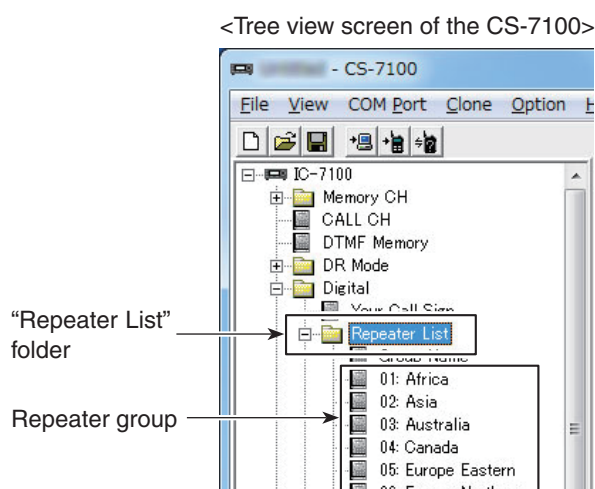

## Touch screen calibration function

When no action occurs, or a different function is activated after touching the screen, the touched point and the detected range may be different. In this case, the Touch screen calibration function helps you to correct the touch screen performance.

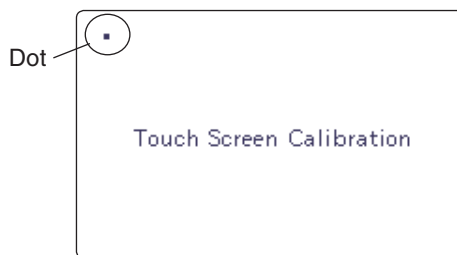

- ① Touch the “Touch Screen Calibration” item of the “Others” Set mode.  
(**SET**)(**C**) > Others > **Touch Screen Calibration**)
- ② Touch the indicated dot on the screen.
  - When touched, the dot appears on another place.
- ③ Repeat step ②.
  - When the calibration is completed, the transceiver returns to the previous screen.

## Dial tuning tension adjustment

The tuning tension of the Dial may be adjusted to suit your preference.

The tension adjustment is located on the side of the front panel, as shown to the right.

Slide the tension adjustment to a comfortable level while turning the Dial continuously and evenly in one direction.

If you want to feel the response of clicking when rotating the Dial, slide the tension adjustment to the top.

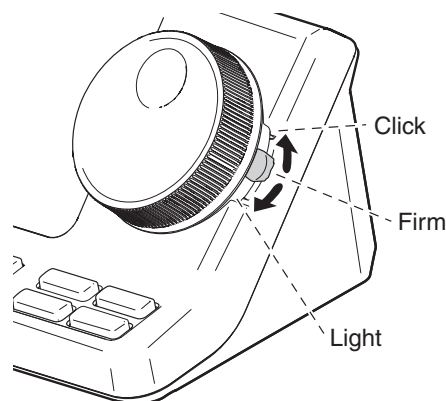

## Protection function

The transceiver has a 2-step protection function to protect the final power amplifiers.

The protector monitors the power amplifier temperature and activates when the temperature becomes extremely high.

- Reduced power transmission  
Reduces the transmit output power.  
“LMT” appears instead of the TX indicator during transmit.
- Transmission inhibit  
Deactivates the transmitter.  
“HOT” blinks instead of the TX indicator.

When the protector is activated, wait until the power amplifier cools down, using the transceiver in only the stand-by or receive mode.

**DO NOT** turn the transceiver power OFF when the protector is ON. If you do, the cooling fan will not function and it will take longer to cool the transceiver. The power amplifier temperature can be monitored in the multi-function meter, TEMP gauge.

Wait until the power amplifier completely gets cool.

TX inhibit zone

- HF/50 MHz band: Right side of ①
- 144/430 MHz band: Right side of ②

## External keypad connections

Connect an external keypad to the MIC connector to control the keyer memory (M1 to M4), RTTY memory (RT1 to RT4) or TX voice memory (T1 to T4). You can send a memory keyer, RTTY memory or voice memory without selecting the screen of the CW memory, RTTY memory or voice memory.

When using a external keypad, set the “External Keypad” item of the “Connectors” Set mode, as described below:

- For the CW memory keyer, set the “KEYER” item to ON.
- For the RTTY memory, set the “RTTY” item to ON.
- For the TX voice memory, set the “VOICE” item to ON.

/// An external keypad should be purchased separately.

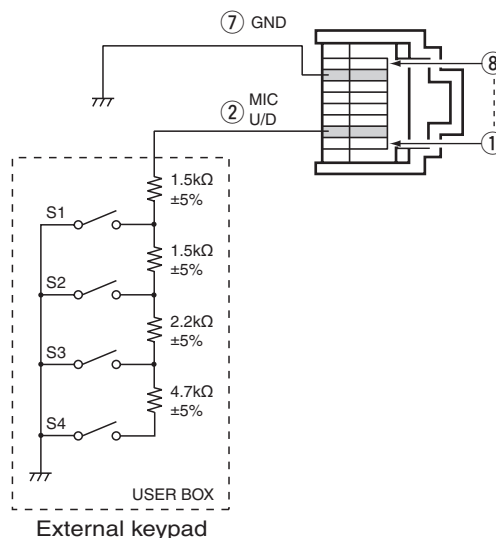

## Band voltage modification

The transceiver does not output the band voltage from the [ACC] socket by default because there is no option that the band voltage is required. The band voltage is output from pin 5 of the [ACC] socket after bridging the solder pad, as shown to the right.

Or, you can output the band voltage by making the following band voltage generator circuit. The following band voltage table is for reference only. Please adjust and check with the actual operating results.

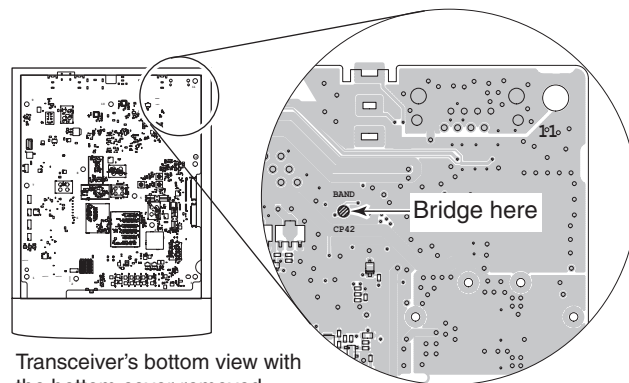

Transceiver's bottom view with the bottom cover removed.

### • Band voltage generator circuit

The circuit below is just for reference.

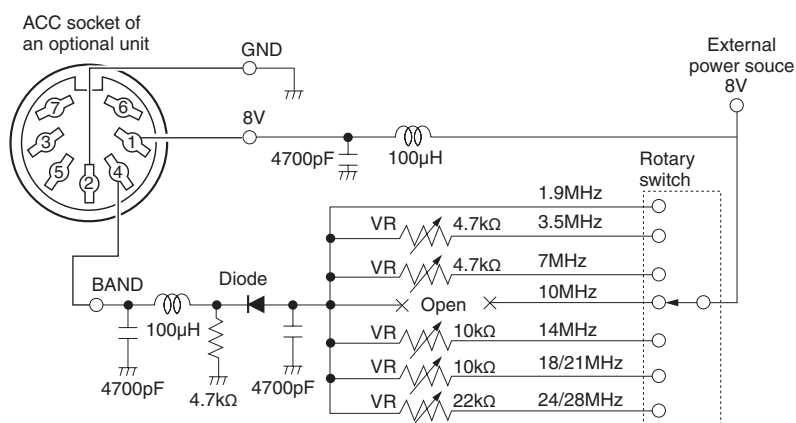

BAND	VOLTAGE
1.9 MHz	No adjustment
3.5 MHz	6.1 V
7 MHz	5.1 V
10 MHz	No adjustment
14 MHz	4.1 V
18/21 MHz	3.1 V
24/28 MHz	2.1 V

## Troubleshooting

The following chart is designed to help you correct problems which are not equipment malfunctions.

If you are unable to locate the cause of a problem, or solve it through the use of this chart, contact your nearest Icom Dealer or Service Center.

### ◇ Transceiver power

PROBLEM	POSSIBLE CAUSE	SOLUTION	REF.
Power does not turn ON when [PWR] is pushed.	• The power cable is improperly connected.	• Reconnect the DC power cable correctly.	Sec. 2
	• A fuse is blown.	• Correct the cause, then replace the fuse with an equivalent fuse. (Fuses are installed in the DC power cable and in the internal PA unit.)	Sec. 19
	• Power output voltage is not correct.	• Use power supply with 13.8 V DC output.	Sec. 2

### ◇ Transmit and receive

PROBLEM	POSSIBLE CAUSE	SOLUTION	REF.
No sound from the speaker.	• The audio volume level is too low.	• Rotate the [AF] control clockwise to obtain a suitable listening level.	Sec. 3
	• The squelch is closed.	• Rotate the [RF/SQL] control to 12 o'clock position to open the squelch.	Sec. 3
	• The tone squelch is ON in the FM mode.	• Turn OFF the Tone squelch.	Sec. 4
	• The external speaker is not connected.	• Correct the cause, then correct.	Sec. 2
	• A head-phone or external speaker is connected to [PHONES/SP].	• Disconnect the head-phone or external speaker.	Sec. 2
Sensitivity is too low, and only strong signals can be heard.	• The antenna is not properly connected.	• Reconnect to the antenna connector.	Sec. 2
	• The attenuator is turned ON.	• Push [P.AMP/ATT] to turn OFF the attenuator.	Sec. 5
	• The RF gain sensitivity is set to minimum.	• Rotate the [RF/SQL] control to 12 o'clock position.	Sec. 3
Received audio in the SSB mode is unclear or distorted.	• The squelch is closed.	• Rotate the [RF/SQL] control to adjust the squelch level.	Sec. 3
	• The antenna for another band is selected.	• Select an antenna suitable for the operating frequency.	Sec. 2
	• The side band setting is incorrect between USB and LSB.	• Toggle between USB and LSB in the Mode selection screen.	Sec. 3
No contact can be made with another station.	• The PBT function is activated.	• Push [M-CH], and then hold down [CLR] for 1 second to clear the PBT function.	Sec. 5
	• The RIT function is turned ON.	• Push [RIT] to turn OFF the function.	Sec. 5
Output power is too low.	• The Split function and/or Duplex function are turned ON.	• Push [SPLIT] (in the "M1" screen) or [DUP] (in the "M2" screen) to turn OFF the function.	Sec. 6
	• An amateur band is not selected.	• Select an amateur band.	Sec. 3
	• TX power is set too low.	• Push [MIC/RF PWR], and then rotate the [BANK] control clockwise.	Sec. 3
	• The mic gain is set too low. (SSB)	• Push [MIC/RF PWR], and then rotate the [M-CH] control clockwise.	Sec. 3
	• The antenna is bad, or the coaxial cable is shorted or open.	• Correct the cause.	Sec. 2
	• The microphone is bad, or the [MIC] connector is shorted.	• Correct the cause.	Sec. 2
Transmit signal is unclear or distorted.	• The antenna SWR is more than 3.	• Set the antenna SWR less than 3.	Sec. 6
	• The MIC gain is adjusted too high.	• Rotate [M-CH] so that the ALC meter reading stays within the ALC zone.	Sec. 3
	• The Speech compressor level is adjusted too high.	• Rotate the Dial so that the COMP meter reading stays within the COMP level zone.	Sec. 6

## Troubleshooting

### ◇ Transmit and receive (Continued)

PROBLEM	POSSIBLE CAUSE	SOLUTION	REF.
The antenna is not properly tuned.	<ul style="list-style-type: none"> <li>The antenna SWR is adjusted too high.</li> <li>Check the coaxial cable.</li> </ul>	<ul style="list-style-type: none"> <li>Adjust the antenna SWR.</li> <li>Change the length of the coaxial cable.</li> </ul>	Sec. 6 Sec. 2
The supply voltage decreases when transmitting.	<ul style="list-style-type: none"> <li>The capacity of power supply is too low.</li> </ul>	<ul style="list-style-type: none"> <li>Use a power supply with capacity of at least 22 Amperes.</li> </ul>	Sec. 2
The continuous transmissions is inhibited.	<ul style="list-style-type: none"> <li>The time-out timer activates.</li> </ul>	<ul style="list-style-type: none"> <li>Turn OFF the time-out timer function.</li> </ul>	Sec. 17
Transmitting is impossible in AM.	<ul style="list-style-type: none"> <li>The 144/430 MHz frequency band is selected.</li> </ul>	<ul style="list-style-type: none"> <li>Select the HF/50 MHz frequency band.</li> </ul>	Sec.3
No voice synthesizer audio from the speaker.	<ul style="list-style-type: none"> <li>The speech level is set to minimum.</li> </ul>	<ul style="list-style-type: none"> <li>Adjust the speech level.</li> </ul>	Sec. 17
Cloning error occurs when reading or writing through the USB cable.	<ul style="list-style-type: none"> <li>The <b>CI-V</b> data transfer speed is set to 300 or 1200 bps.</li> <li>The CI-V data transfer speed is set to Auto, but cloning is performed with 300 or 1200 bps.</li> </ul>	<ul style="list-style-type: none"> <li>Set the CI-V data transfer speed to other than 300 and 1200 bps.</li> <li>Select the Clone mode in the Others Set mode.</li> </ul>	Sec. 17 CS-7100 Instruction manual

### ◇ Display

PROBLEM	POSSIBLE CAUSE	SOLUTION	REF.
The displayed frequency does not change.	<ul style="list-style-type: none"> <li>The dial lock function is turned ON.</li> </ul>	<ul style="list-style-type: none"> <li>Hold down <b>[SPEECH]</b> for 1 second to turn OFF the function.</li> </ul>	Sec. 5

### ◇ Scanning

PROBLEM	POSSIBLE CAUSE	SOLUTION	REF.
A Programmed scan does not start.	<ul style="list-style-type: none"> <li>The same frequencies have been programmed into both "1A-3A" and "1B-3B" of the scan edge memory channels.</li> </ul>	<ul style="list-style-type: none"> <li>Program different frequencies into the "1A-3A" and "1B-3B" scan edge memory channels.</li> </ul>	Sec. 12
A Memory scan does not start.	<ul style="list-style-type: none"> <li>2 or more memory channels have not been programmed.</li> </ul>	<ul style="list-style-type: none"> <li>Program more than 2 memory channels.</li> </ul>	Sec. 11
A Select memory scan does not start.	<ul style="list-style-type: none"> <li>2 or more memory channels have not been designated as select channels.</li> </ul>	<ul style="list-style-type: none"> <li>Designate more than 2 memory channels as select channels for the scan.</li> </ul>	Sec. 12
A Mode select memory scan does not start.	<ul style="list-style-type: none"> <li>2 or more memory channels with the desired mode have not been programmed.</li> </ul>	<ul style="list-style-type: none"> <li>Program more than 2 memory channels with the desired operating mode.</li> </ul>	Sec. 11

Troubleshooting

◇ While operating **D-STAR**

PROBLEM	POSSIBLE CAUSE	SOLUTION	REF.
After your call, the repeater does not return a status reply.	<ul style="list-style-type: none"> <li>The access repeater setting is wrong.</li> <li>The repeater setting is wrong.</li> <li>Your transmission did not reach the repeater.</li> </ul>	<ul style="list-style-type: none"> <li>Select the correct repeater.</li> <li>Correct the repeater frequency, frequency offset, or duplex setting.</li> <li>Wait until you are closer to the repeater and try again.</li> </ul>	Sec. 8 Sec. 9 —
After your call, the repeater replies 'UR?' and its call sign.	<ul style="list-style-type: none"> <li>The call was successfully sent, but no station immediately replied.</li> </ul>	<ul style="list-style-type: none"> <li>Wait for a while, and try again.</li> </ul>	Sec. 8
After your call, the repeater replies 'RX' or 'RPT?' and the access repeater's call sign.	<ul style="list-style-type: none"> <li>Your own call sign (MY) has not been set.</li> <li>Your own call sign (MY) has not been registered on a gateway repeater, or the registered contents do not match your transceiver's setting.</li> </ul>	<ul style="list-style-type: none"> <li>Set your own call sign (MY).</li> <li>Register your own call sign (MY) on a gateway repeater, or confirm the registration of the call sign.</li> </ul>	Sec. 7 Sec. 7
After your call, the repeater replies 'RPT?' and call sign of the destination repeater.	<ul style="list-style-type: none"> <li>The repeater cannot connect to the destination repeater.</li> <li>The repeater is busy.</li> </ul>	<ul style="list-style-type: none"> <li>Check the repeater setting.</li> <li>Wait for a while, and try it again.</li> </ul>	Sec. 8 —
After your call, the access repeater replies 'RPT?' and its call sign.	<ul style="list-style-type: none"> <li>The call sign of the destination repeater is wrong.</li> </ul>	<ul style="list-style-type: none"> <li>Correctly set the destination repeater call sign.</li> </ul>	Sec. 9
Even holding down <b>DR</b> , the DR mode will not appear.	<ul style="list-style-type: none"> <li>There is no repeater list in your radio.</li> </ul>	<ul style="list-style-type: none"> <li>Reload the repeater list using the CS-7100 cloning software on the CD.</li> <li>Reload the repeater list using an SD card.</li> <li>Enter the Repeater list data directly into the transceiver.</li> </ul>	Sec. 19 Sec. 13, 19 Sec. 9
Even holding down <b>AUTO TUNER (RX-PCS)</b> , the received call sign will not set to the destination call sign.	<ul style="list-style-type: none"> <li>The call sign has not been correctly received.</li> <li>When a received signal is weak, or a signal is received during scanning, the call sign may not be received correctly. In that case, "-----" appears and error beeps sound, and a reply call cannot be made.</li> </ul>	<ul style="list-style-type: none"> <li>Try it again, after the transceiver has correctly received the call sign.</li> </ul>	—
A Local area call can be made, but a Gateway call or destination station call cannot be made.	<ul style="list-style-type: none"> <li>MY call sign has not been registered on a D-STAR repeater.</li> </ul>	<ul style="list-style-type: none"> <li>Register your own call sign (MY) on a gateway repeater, or confirm the registration of the call sign.</li> </ul>	Sec. 7
During transmission, "L" appears on the LCD, and the received audio is interrupted.	<ul style="list-style-type: none"> <li>While receiving through the internet, some packets may be lost due to network error (poor data throughput performance).</li> </ul>	<ul style="list-style-type: none"> <li>Wait a while, and try it again.</li> <li>When the transceiver receives corrupted data, and misidentifies it as Packet Loss, "L" is displayed, even if it is a Local area call.</li> </ul>	Sec. 9
"DV" and "FM" icons alternately blink.	<ul style="list-style-type: none"> <li>While in the DV mode, an FM signal is received.</li> </ul>	<ul style="list-style-type: none"> <li>Use a different operating frequency until there are no FM signals on the original frequency.</li> </ul>	Sec. 9
Simplex operation cannot be made in the DR mode.	<ul style="list-style-type: none"> <li>A call sign is programmed in "CALL SIGN" of the Repeater list.</li> <li>Duplex mode (DUP+, DUP-) is set.</li> <li>A repeater frequency is programmed.</li> </ul>	<ul style="list-style-type: none"> <li>Delete the Call sign in "CALL SIGN" setting of the Repeater list.</li> <li>Select "OFF" in "DUP" setting of the repeater list.</li> <li>Enter a simplex frequency.</li> </ul>	Sec. 9 Sec. 9 Sec. 9
The digital code squelch (CSQL) is impossible.	<ul style="list-style-type: none"> <li>The wrong digital code is set.</li> </ul>	<ul style="list-style-type: none"> <li>Set the correct digital code.</li> </ul>	Sec. 9
You don't know how to update the repeater list.	—	<ul style="list-style-type: none"> <li>See "Updating the repeater list."</li> </ul>	Sec. 13

## Section 20 CONTROL COMMAND

---

<b>Remote jack (CI-V) information .....</b>	<b>20-2</b>
◇ CI-V connection example .....	20-2
◇ Data format.....	20-2
◇ Command table .....	20-3
◇ Data content description .....	20-11



## Remote jack (CI-V) information

### ◆ CI-V connection example

The transceiver can be connected through an optional CT-17 CI-V LEVEL CONVERTER to a PC equipped with an RS-232C port. The Icom Communications Interface-V (CI-V) controls the transceiver.

Up to 4 Icom CI-V transceivers or receivers can be connected to the PC. See page 17-25 for setting the CI-V condition using the set mode.

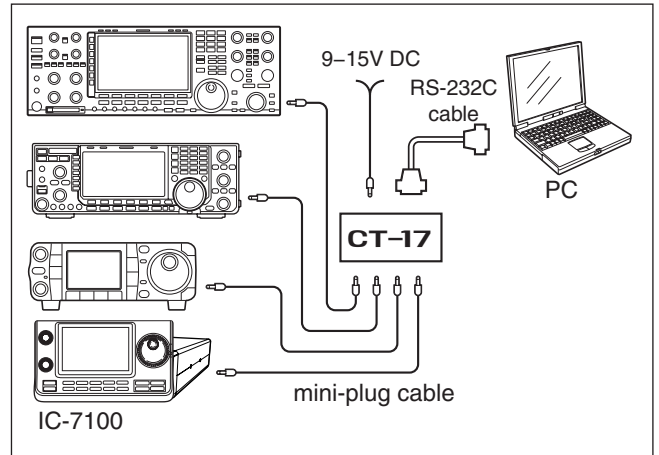

When the transceiver is connected to a PC with the USB cable (purchased separately), the optional CT-17 is not required.

### ◆ Data format

The CI-V system can be operated using the following data formats. Data formats differ depending on command numbers. A data area or sub command is added to some commands.

#### Controller to IC-7100

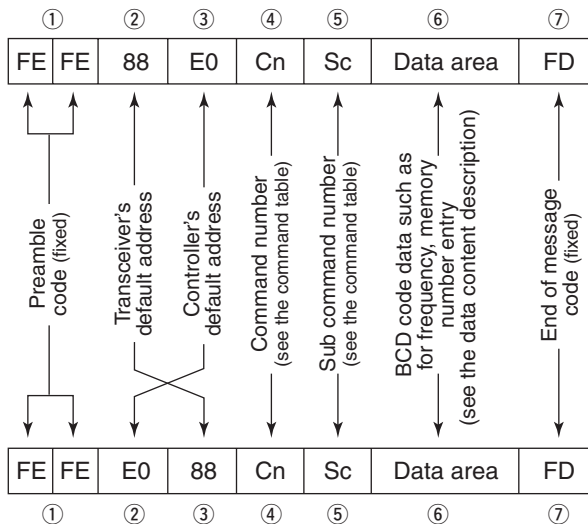

#### IC-7100 to controller

#### OK message to controller

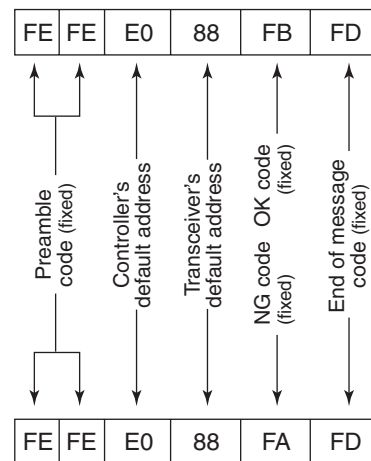

#### NG message to controller

## Remote jack (CI-V) information (Continued)

## ◇ Command table

Cmd.	Sub cmd.	Data	Description	Cmd.	Sub cmd.	Data	Description	
00		see p. 20-11	Send the operating frequency for transceiver	0F		00	Read Split function OFF	
01		see p. 20-11	Send the operating mode for transceiver				01	Read Split function ON
02		see p. 20-12	Read the <b>band</b> edge frequencies				11	Read DUP- operation
03		see p. 20-11	Read the operating frequency				12	Read DUP+ operation
04		see p. 20-11	Read the operating mode				00	Set Split function OFF
05		see p. 20-11	Send the operating frequency				01	Set Split function ON
06		00	Select the LSB mode				10	Set the simplex operation
		01	Select the USB mode				11	Set DUP- operation
		02	Select the AM mode				12	Set DUP+ operation
		03	Select the CW mode		10		00	Send/read the 10 Hz (1 Hz) tuning step
		04	Select the RTTY mode				01	Send/read the 0.1 kHz tuning step
		05	Select the FM mode				02	Send/read the 1 kHz tuning step
		06	Select the WFM mode				03	Send/read the 5 kHz tuning step
		07	Select the CW-R mode				04	Send/read the 6.25 kHz tuning step
		08	Select the RTTY-R mode				05	Send/read the 9 kHz tuning step
	17	Select the DV mode				06	Send/read the 10 kHz tuning step	
07			Select the VFO mode				07	Send/read the 12.5 kHz tuning step
	00		Select VFO A				08	Send/read the 20 kHz tuning step
	01		Select VFO B				09	Send/read the 25 kHz tuning step
	A0		Equalize VFO A and VFO B			10	Send/read the 50 kHz tuning step	
08			Exchange VFO A and VFO B			11	Send/read the 100 kHz tuning step	
			Select the Memory mode			12	Send/read the 1 MHz tuning step	
		0001 to 0109	Select the Memory channel (0001=M-CH01 to 0099=M-CH99, 0100=1A, 0101=1B, 0102=2A, 0103=2B, 0104=3A, 0105=3B, 0106=144-C1, 0107=144-C2, 0108=430-C1, 0109=430-C2)	11		00	Send/read Attenuator OFF	
	A0	01	Select Memory Bank A			12	Send/read 12 dB attenuator	
		02	Select Memory Bank B	13	00		Announce the operating frequency, operating mode and S-meter level by voice synthesizer	
		03	Select Memory Bank C			01		Announce the operating frequency and S meter level by voice synthesizer
		04	Select Memory Bank D			02		Announce the operating mode by voice synthesizer
		05	Select Memory Bank E	14	01	0000 to 0255	Send/read the AF level (0000=min. to 0255=max.)	
	09		Memory write			02	0000 to 0255	Send/read the RF gain level (0000=min., 0255=max.)
	0A		Memory copy to VFO			03	0000 to 0255	Send/read the squelch level (0000=min. to 0255=max.)
0B		Memory clear			06	0000 to 0255	Send/read the NR level (0000=0% to 0255=100%)	
0C		Read offset frequency			07	0000 to 0255	Send/read the inner [TWIN PBT] position (0000=Cutting the higher passband edge, 0128=center, 0255=Cutting the lower passband edge)	
0D		Send offset frequency			08	0000 to 0255	Send/read the outer [TWIN PBT] position (0000=Cutting the higher passband edge, 0128=center, 0255=Cutting the lower passband edge)	
0E	00		Scan stop			09	0000 to 0255	Send/read the CW PITCH (0000=300 Hz, 0128=600 Hz, 0255=900 Hz)
	01		Programmed/memory scan start			0A	0000 to 0255	Send/read the RF power level (0000=min. to 0255=max.)
	02		Programmed scan start			0B	0000 to 0255	Send/read the MIC gain level (0000=min. to 0255=max.)
	03		$\Delta$ F scan start			0C	0000 to 0255	Send/read the KEY SPEED (0000=6 WPM to 0255=48 WPM)
	12		Fine programmed scan start		0D	0000 to 0255	Send/read the NOTCH setting (0000=lowest, 0128=center, 0255=highest)	
	13		Fine $\Delta$ F scan start					
	22		Memory scan start					
	23		Select memory scan start					
	24		Mode select scan start					
	A1		Set the $\pm$ 5 kHz $\Delta$ F scan span					
	A2		Set the $\pm$ 10 kHz $\Delta$ F scan span					
	A3		Set the $\pm$ 20 kHz $\Delta$ F scan span					
	A4		Set the $\pm$ 50 kHz $\Delta$ F scan span					
	A5		Set the $\pm$ 100 kHz $\Delta$ F scan span					
	A6		Set the $\pm$ 500 kHz $\Delta$ F scan span					
A7		Set the $\pm$ 1 MHz $\Delta$ F scan span						
B0		Set as the Non-select Memory channel						
B1		Set as the Select Memory channel						
D0		Set Scan resume function OFF						
D3		Set Scan resume function ON						

Remote jack (CI-V) information

◇ Command table (Continued)

Cmd.	Sub cmd.	Data	Description
14	0E	0000 to 0255	Send/read the COMP level (0000=0 to 0255=10)
	0F	0000 to 0255	Send/read the Break-IN Delay setting (0000=2.0d to 0255=13.0d)
	12	0000 to 0255	Send/read <b>NB</b> level (0000=0% to 0255=100%)
	15	0000 to 0255	Send/read the Monitor gain level (0000=0% to 0255=100%)
	16	0000 to 0255	Send/read the VOX gain level (0000=0% to 0255=100%)
	17	0000 to 0255	Send/read the Anti VOX gain level (0000=0% to 0255=100%)
	18	0000 to 0255	Send/read the LCD contrast level (0000=0% to 0255=100%)
	19	0000 to 0255	Send/read the LCD backlight level (0000=0% to 0255=100%)
	15	01	00
01			Read the squelch status (squelch open)
02		0000 to 0255	Read the S-meter level (0000=S0, 0120=S9, 0241=S9+60 dB)
05		00	Read various SQL function's status (squelch closed)
		01	Read various SQL function's status (squelch open)
11		0000 to 0255	Read the PO meter level (0000=0%, 0143=50%, 213=100%)
12		0000 to 0255	Read the SWR meter level (0000=SWR1.0, 0048=SWR1.5, 0080=SWR2.0, 0120=SWR3.0)
13		0000 to 0255	Read the <b>ALC</b> meter level (0000=Min. to 0120=Max.)
14		0000 to 0255	Read the COMP meter level (0000=0 dB, 0130=15 dB, 0241=30 dB)
15		0000 to 0255	Read the Vd meter level (0000=0 V, 0013=10 V, 0241=16 V)
16		0000 to 0255	Read the Id meter level (0000=0, 0097=10, 0146=15, 0241=25)
16		02	00
	01		Send/read Preamp ON (144/430 MHz) Send/read Preamp 1 ON (HF/50 MHz)
	02		Send/read Preamp 2 ON (HF/50 MHz)
	12	01	Send/read <b>AGC</b> FAST
		02	Send/read AGC MID
		03	Send/read AGC SLOW
	22	00	Send/read Noise Blanker OFF
		01	Send/read Noise Blanker ON
	40	00	Send/read Noise Reduction OFF
		01	Send/read Noise Reduction ON
	41	00	Send/read Auto Notch function OFF
		01	Send/read Auto Notch function ON
	42	00	Send/read Repeater tone OFF
		01	Send/read Repeater tone ON
	43	00	Send/read Tone squelch OFF
01		Send/read Tone squelch ON	

Cmd.	Sub cmd.	Data	Description
16	44	00	Send/read Speech compressor OFF
		01	Send/read Speech compressor ON
	45	00	Send/read Monitor function OFF
		01	Send/read Monitor function ON
	46	00	Send/read VOX function OFF
		01	Send/read VOX function ON
	47	00	Send/read BK-IN function OFF
		01	Send/read Semi BK-IN function ON
		02	Send/read Full BK-IN function ON
	48	00	Send/read Manual notch function OFF
		01	Send/read Manual notch function ON
	4B	00	Send/read <b>DTCS</b> OFF
		01	Send/read DTCS ON
	4C	00	Send/read VSC function OFF
		01	Send/read VSC function ON
	4F	00	Send/read Twin Peak Filter OFF
		01	Send/read Twin Peak Filter ON
	50	00	Send/read Dial lock function OFF
		01	Send/read Dial lock function ON
	56	00	Send/read <b>DSP</b> filter type SHARP
		01	Send/read DSP filter type SOFT
	57	00	Send/read manual notch width WIDE
		01	Send/read manual notch width MID
		02	Send/read manual notch width NAR
	58	00	Send/read SSB transmit <b>bandwidth</b> WIDE
		01	Send/read SSB transmit bandwidth MID
		02	Send/read SSB transmit bandwidth NAR
5B	00	Send/read DSQ/CSQ OFF (DV mode only)	
	01	Send/read DSQ ON (DV mode only)	
	02	Send/read CSQ ON (DV mode only)	
17		see p. 20-11	Send CW messages*1
18	00		Turn OFF the transceiver
	01		Turn ON the transceiver*2

\*1 In the CW mode, if an external TX switch is ON, or the Break-in function is ON, a message will be transmitted as CW code when you send it from your PC.

\*2 When sending the power ON command (18 01), the command "FE" must be sent before the basic format.

- 19200 bps: 25, • 9600 bps: 13, • 4800 bps: 7,
- 1200 bps: 3, • 300 bps: 2

Example: When operating with 4800 bps

		①	②	③	④	⑤	⑦
F	E	F	E	8	8	E	O
		1	8	0	1	F	D

x 7

- ① Preamble code (fixed)
- ② Transceiver's default address
- ③ Controller's default address
- ④ Command number
- ⑤ Sub command number
- ⑦ End of message code (fixed)

Remote jack (CI-V) information

◇ Command table (Continued)

Cmd.	Sub cmd.	Data	Description	
19	00		Read the transceiver ID	
1A	00	see p. 20-16	Send/read the Memory channel contents	
	01	see p. 20-12	Send/read the Band stacking register contents	
	02	see p. 20-13	Send/read the Memory keyer contents*	
	03	00 to 49	Send/read the selected filter width (AM: 00=200 Hz to 49=10 kHz; other than AM modes: 00=50 Hz to 40/31=3600 Hz/2700 Hz)	
	04	00 to 13	Send/read the selected AGC time constant (00=OFF, AM: 01=0.3 sec. to 13=8.0 sec., SSB/CW/RTTY: 01=0.1 sec. to 13=6.0 sec.)	
	05	0001	00/01	Send/read the TX Monitor function setting (00=OFF, 01=ON)
		0002	0000 to 0255	Send/read the TX Monitor level (0000=0% to 0255=100%)
		0003		Send/read the Beep level (0000=0% to 0255=100%)
		0004	00/01	Send/read the Beep level limit setting (00=OFF, 01=ON)
		0005	00/01	Send/read the Confirmation beep setting (00=OFF, 01=ON)
		0006	00 to 03	Send/read the Band edge beep setting (00=OFF, 01=ON(Default), 02=ON(User), 03=ON(User & TX Limit))
		0007	00 to 02	Send/read the RF/SQL Control setting (00=Auto, 01=SQL, 02=RF+SQL)
		0008	00 to 05	Send/read the TX Delay setting (HF) (00=OFF, 01=10ms, 02=15ms, 03=20ms, 04=25ms, 05=30ms)
		0009	00 to 05	Send/read the TX Delay setting (50M) (00=OFF, 01=10ms, 02=15ms, 03=20ms, 04=25ms, 05=30ms)
0010		00 to 05	Send/read the TX Delay setting (70M) (00=OFF, 01=10ms, 02=15ms, 03=20ms, 04=25ms, 05=30ms)	
0011	00 to 05	Send/read the TX Delay setting (144M) (00=OFF, 01=10ms, 02=15ms, 03=20ms, 04=25ms, 05=30ms)		
0012	00 to 05	Send/read the TX Delay setting (430M) (00=OFF, 01=10ms, 02=15ms, 03=20ms, 04=25ms, 05=30ms)		
0013	00 to 05	Send/read the Time-Out Timer setting (0=OFF, 1=3 min., 2=5 min., 3=10 min., 4=20 min., 5=30 min.)		
0014	00/01	Send/read the PTT Lock function setting (00=OFF, 01=ON)		

Cmd.	Sub cmd.	Data	Description	
1A	05	0015	00/01	Send/read the Quick Split function setting (00=OFF, 01=ON)
		0016	see p. 20-13	Send/read the Split offset frequency
		0017	00/01	Send/read the Split Lock function setting (00=OFF, 01=ON)
		0018	see p. 20-13	Send/read the Duplex offset frequency
		0019	00/01	Send/read the One Touch Repeater setting (00=DUP-, 01=DUP+)
		0020	00 to 02	Send/read the Auto Repeater setting (0=OFF, 1=ON(DUP) (for USA version) or ON (for Korea version), 2=ON(DUP,TONE)(for USA version)
		0021	00/01	Send/read the Tuner Auto Start setting (00=OFF, 01=ON)
		0022	00/01	Send/read the PTT Tune setting (00=OFF, 01=ON)
		0023	00	Send/read the Manual selection for the [TUNER] Switch function.
			01	Send/read the Auto selection for the [TUNER] Switch function.
		0024	00/01	Send/read [SPEECH/LOCK] key function setting (00=Push: SPEECH, Hold down: LOCK), 01=Push: LOCK, Hold down: SPEECH)
		0025	00/01	Send/read the Lock function setting (00=MAIN DIAL, 01=PANEL)
		0026	00/01	Send/read the number of memo pad channels (00=5CH, 01=10CH)
		0027	00 to 02	Send/read the Auto TS setting for the Dial (00=OFF, 01=LOW, 02=HIGH)
		0028	00/01	Send/read the microphone Up/Down speed setting (00=Slow, 01=Fast)
		0029	00 to 02	Send/read the Notch function setting for SSB mode (00=Auto, 01=Manual, 02=Auto/Manual)
		0030	00 to 02	Send/read the Notch function setting for AM mode (00=Auto, 01=Manual, 02=Auto/Manual)
		0031	00/01	Send/read the SSB/CW Synchronous Tuning function setting (00=OFF, 01=ON)
		0032	00/01	Send/read the CW normal side setting (00=LSB, 01=USB)
		0033	00/01	Send/read the voice 1st menu (00=VOICE-Root, 01=VOICE-TX)
		0034	00/01	Send/read the keyer 1st menu (00=KEYER-Root, 01=KEYER-SEND)

\* The counter can be inserted into only one channel. Before inserting the counter, be sure to clear the counter on another channel.

## Remote jack (CI-V) information

## ◇ Command table (Continued)

Cmd.	Sub cmd.	Data	Description	Cmd.	Sub cmd.	Data	Description		
1A	05	0035	00/01	Send/read the Speaker output setting (00=OFF, 01=ON)	1A	05	0050	00/01	Send/read the S-Level SPEECH function setting (00=OFF, 01=ON)
		0036	00/01	Send/read the MIC AF output setting (00=OFF, 01=ON)			0051	00/01	Send/read the MODE SPEECH function setting (00=OFF, 01=ON)
		0037	00 to 22	Send/read the function of [F-1] on the HM-151 (00=---, 01=P.AMP/ATT, 02=AGC, 03=NB, 04=NR, 05=NOTCH, 06=RIT, 07=AUTOTUNE/RX>CS, 08=TS, 09=MPAD, 10=M-CLR, 11=BANK, 12=SPLIT, 13=A/B, 14=DUP, 15=TONE/DSQL, 16=COMP, 17=TBW, 18=METER, 19=DR, 20=FROM/TO (DR), 21=SCAN, 22=Voice TX (T1))			0052	00/01	Send/read the speech language (00=English, 01=Japanese)
		0038	00 to 22	Send/read the function of [F-2] on the HM-151 (00=---, 01=P.AMP/ATT, 02=AGC, 03=NB, 04=NR, 05=NOTCH, 06=RIT, 07=AUTOTUNE/RX>CS, 08=TS, 09=MPAD, 10=M-CLR, 11=BANK, 12=SPLIT, 13=A/B, 14=DUP, 15=TONE/DSQL, 16=COMP, 17=TBW, 18=METER, 19=DR, 20=FROM/TO (DR), 21=SCAN, 22=Voice TX (T1))			0053	00/01	Send/read the Alphabet setting for SPEECH (00=Normal, 01=Phonetic Code)
		0039	00/01	Send/read the SSB mode selection of the [MODE] key on the HM-151 (00=OFF, 01=ON)			0054	00/01	Send/read the speech speed setting (00=Slow, 01=Fast)
		0040	00/01	Send/read the CW mode selection of the [MODE] key on the HM-151 (00=OFF, 01=ON)			0055	0000 to 0255	Send/read the speech level (0000=0% to 0255=100%)
		0041	00/01	Send/read the RTTY mode selection of the [MODE] key on the HM-151 (00=OFF, 01=ON)			0056	see p. 20-11	Send/read the SSB RX HPF/LPF setting
		0042	00/01	Send/read the AM mode selection of the [MODE] key on the HM-151 (00=OFF, 01=ON)			0057	00 to 10	Send/read the SSB RX Tone (Bass) level (00=-5 to 10=+5)
		0043	00/01	Send/read the FM mode selection of the [MODE] key on the HM-151 (00=OFF, 01=ON)			0058	00 to 10	Send/read the SSB RX Tone (Treble) level (00=-5 to 10=+5)
		0044	00/01	Send/read the DV mode selection of the [MODE] key on the HM-151 (00=OFF, 01=ON)			0059	see p. 20-11	Send/read the AM RX HPF/LPF setting
		0045	00/01	Send/read the WFM mode selection of the [MODE] key on the HM-151 (00=OFF, 01=ON)			0060	00 to 10	Send/read the AM RX tone (Bass) level (00=-5 to 10=+5)
		0046	00/01	Send/read the Power OFF setting when no controller is connected. (00=OFF, 01=ON)			0061	00 to 10	Send/read the AM RX Tone (Treble) level (00=-5 to 10=+5)
		0047	0000 to 0255	Send/read the REF Adjust setting (0000=0%, 0128=50%, 0255=100%)			0062	see p. 20-11	Send/read the FM RX HPF/LPF setting
		0048	00 to 02	Send/read the RX Call Sign SPEECH setting (00=OFF, 01=ON (Kerchunk), 02=ON (All))			0063	00 to 10	Send/read the FM RX tone (Bass) level (00=-5 to 10=+5)
		0049	00/01	Send/read the RX>CS SPEECH function setting (00=OFF, 01=ON)			0064	00 to 10	Send/read the FM RX Tone (Treble) level (00=-5 to 10=+5)
				0065	see p. 20-11	Send/read the DV RX HPF/LPF setting			
				0066	00 to 10	Send/read the DV RX tone (Bass) level (00=-5 to 10=+5)			
				0067	00 to 10	Send/read the DV RX Tone (Treble) level (00=-5 to 10=+5)			
				0068	00 to 10	Send/read the WFM RX Tone (Bass) level (00=-5 to 10=+5)			
				0069	00 to 10	Send/read the WFM RX Tone (Treble) level (00=-5 to 10=+5)			
				0070	00 to 10	Send/read the CW RX HPF/LPF setting			
				0071	00 to 10	Send/read the RTTY RX HPF/LPF setting			
				0072	00 to 10	Send/read the SSB TX Tone (Bass) level (00=-5 to 10=+5)			
				0073	00 to 10	Send/read the SSB TX Tone (Treble) level (00=-5 to 10=+5)			



Remote jack (CI-V) information

◇ Command table (Continued)

Cmd.	Sub cmd.	Data	Description	Cmd.	Sub cmd.	Data	Description
1A	05	0074	see p. 20-11 Send/read the WIDE SSB TX bandwidth	1A	05	0096	00 to 02 Send/read the "USB2" (COM port) function setting (00=OFF, 01=RTTY Decode, 02=DV Data)
		0075	see p. 20-11 Send/read the MID SSB TX bandwidth			0097	00 to 03 Send/read the [DATA1] function setting (00=OFF, 01=RTTY Decode, 02=DV Data, 03=GPS)
		0076	see p. 20-11 Send/read the NARROW SSB TX bandwidth			0098	00/01 Send/read the GPS output setting (00=OFF, 01=DATA1→USB2)
		0077	00 to 10 Send/read the AM TX tone (Bass) level (00=-5 to 10=+5)			0099	00/01 Send/read the DV or GPS data transfer speed (00=4800 bps, 01=9600 bps)
		0078	00 to 10 Send/read the AM TX Tone (Treble) level (00=-5 to 10=+5)			0100	00 to 04 Send/read the RTTY decode speed (00=300 bps, 01=1200 bps, 02=4800 bps, 03=9600 bps, 04=19200 bps)
		0079	00 to 10 Send/read the FM TX tone (Bass) level (00=-5 to 10=+5)			0101	00 to 02 Send/read the band setting for the [ACC] socket's pin 7 (VSEND usage) (00=OFF, 01=UHF, 02=VHF/UHF)
		0080	00 to 10 Send/read the FM TX Tone (Treble) level (00=-5 to 10=+5)			0102	00/01 Send/read the 9600bps Mode setting (00=OFF, 01=ON)
		0081	00 to 10 Send/read the DV TX tone (Bass) level (00=-5 to 10=+5)			0103	0000 to 0255 Send/read the LCD contrast setting (0000=0% to 0255=100%)
		0082	00 to 10 Send/read the DV TX Tone (Treble) level (00=-5 to 10=+5)			0104	0000 to 0255 Send/read the LCD Backlight setting (0000=0% to 0255=100%)
		0083	00/01 Send/read the USB audio squelch setting (00=OFF (OPEN), 01=ON)			0105	0000 to 0255 Send/read the Key Backlight setting (0000=0% to 0255=100%)
		0084	00/01 Send/read the ACC and USB output setting (00=AF, 01=IF)			0106	00/01 Send/read the Meter Peak Hold setting (00=OFF, 01=ON)
		0085	0000 to 0255 Send/read the ACC and USB AF output Level (0000=0% to 0255=100%)			0107	00/01 Send/read the PBT shifting value display setting while rotating [TWIN PBT] (00=OFF, 01=ON)
		0086	0000 to 0255 Send/read the ACC and USB IF output Level (0000=0% to 0255=100%)			0108	00/01 Send/read the IF filter width and shifting value display setting when the IF filter is switched (00=OFF, 01=ON)
		0087	0000 to 0255 Send/read the ACC modulation level (0000=0% to 0255=100%)			0109	00 to 02 Send/read the RX Call sign display setting (00=OFF, 01=AUTO, 02=Auto (RX Hold))
		0088	0000 to 0255 Send/read the DATA modulation level (0000=0% to 0255=100%)			0110	00/01 Send/read the RX message display setting (00=OFF, 01=ON)
		0089	0000 to 0255 Send/read the USB modulation level (0000=0% to 0255=100%)	0111	00/01 Send/read the RX position display setting when the received Auto Reply signal includes the position (00=OFF, 01=ON)		
		0090	00 to 03 Send/read the modulation input setting in the DATA mode OFF (00=MIC, 01=ACC, 02=MIC,ACC, 03=USB)	0112	00 to 02 Send/read the TX Call sign display setting (00=OFF, 01=Your Call Sign, 02=My Call Sign)		
		0091	00 to 03 Send/read the modulation input setting in the DATA mode ON (00=MIC, 01=ACC, 02=MIC,ACC, 03=USB)	0113	00/01 Send/read the Scroll Speed setting (00=Slow, 01=Fast)		
		0092	00/01 Send/read the external keypad setting for VOICE (00=OFF, 01=ON)	0114	00/01 Send/read the VOICE TX Name Display setting (00=OFF, 01=ON)		
		0093	00/01 Send/read the external keypad setting for Memory KEYER (00=OFF, 01=ON)	0115	00/01 Send/read the KEYER Memory Display setting (00=OFF, 01=ON)		
0094	00/01 Send/read the external keypad setting for RTTY Memory (00=OFF, 01=ON)						
0095	00/01 Send/read the CI-V transceive setting (00=OFF, 01=ON)						

Remote jack (CI-V) information

◇ Command table (Continued)

Cmd.	Sub cmd.	Data	Description
1A	05	0116	00/01 Send/read the Opening Message (00=OFF, 01=ON)
		0117	00/01 Send/read the Power ON Check setting (00=OFF, 01=ON)
		0118	00/01 Send/read the Display Language (00=English, 01=Japanese)
		0119	00/01 Send/read the System Language (00=English, 01=Japanese)
		0120	20000101 to 20991231 Send/read the date setting (20000101=2000/01/01 to 20991231=2099/12/31)
		0121	0000 to 2359 Send/read the time setting (0000(0:00) to 2359(23:59))
		0122	00/01 Send/read the GPS time correction setting (00=OFF, 01=Auto)
		0123	see p. 20-13 Send/read the UTC offset setting
		0124	00/01 Send/read the clock display mode (00=LOCAL, 01=UTC)
		0125	00 to 04 Send/read the Auto Power OFF function setting (00=OFF, 01=30 min., 02=60 min., 03=90 min., 04=120 min.)
		0126	00 to 10 Send/read the compression level (00=0 to 10=10)
		0127	00 to 14 Send/read the repeat interval to transmit the recorded voice audio (00=1 sec. to 14=15 sec.)
		0128	00/01 Send/read the TX voice audio monitor function setting (00=OFF, 01=ON)
		0129	00 to 04 Send/read the numbering system used for contest (serial) numbers (00=Normal, 01=190 ANO, 02=190 ANT, 03=90 NO, 04=90 NT)
		0130	01 to 04 Send/read the count-up trigger channel (01=M1 to 04=M4)
		0131	0001 to 9999 Send/read the current contest serial number (0001=1 to 9999=9999)
		0132	0000 to 0255 Send/read the CW sidetone level (0000=0% to 0255=100%)
		0133	00/01 Send/read the CW sidetone level limit setting (00=OFF, 01=ON)
		0134	01 to 60 Send/read the CW keyer repeat time (01=1 sec. to 60=60 sec.)
		0135	28 to 45 Send/read the CW keyer dot/dash ratio (28=1:1.2.8 to 45=1:1.4.5)
0136	00 to 03 Send/read the CW Rise time setting (00=2 msec, 01=4 msec, 02=6 msec, 03=8 msec)		
0137	00/01 Send/read the paddle polarity setting (00=Normal, 01=Reverse)		
0138	00 to 02 Send/read the keyer type setting (00=Straight, 01=BUG-Key, 02=ELEC-Key)		

Cmd.	Sub cmd.	Data	Description
1A	05	0139	00/01 Send/read Mic. up/down keyer setting (00=OFF, 01=ON)
		0140	00/01 Send/read the Twin Peak Filter setting (00=OFF, 01=ON)
		0141	00 to 02 Send/read the RTTY mark frequency (00=1275 Hz, 01=1615 Hz, 02=2125 Hz)
		0142	00 to 02 Send/read the RTTY shift width (00=170 Hz, 01=200 Hz, 02=425 Hz)
		0143	00/01 Send/read the RTTY keying polarity (00=Normal, 01=Reverse)
		0144	00/01 Send/read the RTTY decode USOS setting (00=OFF, 01=ON)
		0145	00/01 Send/read the RTTY decode new line code setting (00=CR,LF,CR+LF, 01=CR+LF)
		0146	00/01 Send/read the RTTY TX USOS setting (00=OFF, 01=ON)
		0147	00/01 Send/read the RTTY Decode Log setting (00=OFF, 01=ON)
		0148	00/01 Send/read the RTTY Decode Log file type (00=Text, 01=HTML)
		0149	00/01 Send/read the RTTY Decode Log Time Stamp setting (00=OFF, 01=ON)
		0150	00/01 Send/read the RTTY Decode Log Time Stamp (Time) (00=Local, 01=UTC)
		0151	00/01 Send/read the RTTY Decode Log Time Stamp (Frequency) (00=OFF, 01=ON)
		0152	00 to 03 Send/read the <b>DTMF</b> Speed setting (00=100 msec., 01=200 msec., 02=300 msec., 03=500 msec.)
		0153	00/01 Send/read the Scan speed setting (00=Slow, 01=Fast)
		0154	00/01 Send/read the Scan resume setting (00=OFF, 01=ON)
		0155	00 to 10 Send/read the Scan pause timer setting (00=2 sec. to 09=20 sec., 10=HOLD)
		0156	00 to 06 Send/read the Scan resume timer (00=0 sec. to 05=5 sec., 6=HOLD)
		0157	00/01 Send/read the Dial function during a scan (00=OFF, 01=Up/Down)
		0158	0000 to 0255 Send/read the NB level (0000=0% to 0255=100%)
0159	00 to 09 Send/read the NB depth (00=1 to 09=10)		
0160	0000 to 0255 Send/read the NB width (0000=1 to 0255=100)		
0161	00 to 15 Send/read the NR level for other than the DR mode (00=0 to 15=15)		



## Remote jack (CI-V) information

## ◇ Command table (Continued)

Cmd.	Sub cmd.	Data	Description	Cmd.	Sub cmd.	Data	Description
1A	05	0162	00 to 15 Send/read NR level for the DR mode (00=0 to 15=15)	1A	05	0186	see p. 20-13 Send/read the manually programmed position
		0163	0000 to 0255 Send/read the VOX gain (0000=0% to 0255=100%)			0187	00/01 Send/read the GPS Indicator setting (00=OFF, 01=ON)
		0164	0000 to 0255 Send/read the ANTI-VOX gain (0000=0% to 0255=100%)			0188	00/01 Send/read the Position Format setting (00=ddd°mm.mm', 01=ddd°mm'ss")
		0165	00 to 20 Send/read the VOX delay time (00=0.0 sec. to 20=2.0 sec.)			0189	00/01 Send/read the Distance and Altitude unit (00=meter, 01=feet/mile)
		0166	0020 to 0130 Send/read the BK-IN delay time (0020=2.0d to 0130=13.0d)			0190	00 to 02 Send/read the GPS speed unit (00=km/h, 01=mph, 02=knots)
		0167	00/01 Send/read the recording mode (00=TX&RX, 01=RX Only)			0191	see p. 20-13 Send/read GPS alarm area (Group)
		0168	00/01 Send/read the squelch status for the RX voice audio recording (00=Always, 01=Squelch Auto)			0192	00 to 02 Send/read GPS alarm area (RX/Memory) (00=Limited, 01=Extended, 02=Both)
		0169	00/01 Send/read the QSO audio record file Split function setting (00=OFF, 01=ON)			0193	00 to 02 Send/read the GPS TX Mode setting (00=OFF, 01=GPS(DV-G), 02=GPS-A(DV-A))
		0170	00/01 Send/read the PTT Automatic Recording function setting (00=OFF, 01=ON)			0194	00/01 Send/read the GPS (RMC) Sentence setting (00=OFF, 01=ON)
		0171	00 to 03 Send/read the Skip Timer setting while playing back (00=3 sec., 01=5 sec., 02=10 sec., 03=30 sec.)			0195	00/01 Send/read the GPS (GGA) Sentence setting (00=OFF, 01=ON)
		0172	00 to 02 Send/read the Standby Beep setting (00=OFF, 01=ON, 02=ON (to me:High Tone))			0196	00/01 Send/read the GPS (GLL) Sentence setting (00=OFF, 01=ON)
		0173	00 to 02 Send/read Auto Reply setting (00=OFF, 01=ON, 02=Voice)			0197	00/01 Send/read the GPS (GSA) Sentence setting (00=OFF, 01=ON)
		0174	00/01 Send/read the DV Data TX setting (00=PTT, 01=Auto)			0198	00/01 Send/read the GPS (VTG) Sentence setting (00=OFF, 01=ON)
		0175	00 to 02 Send/read the Digital Monitor setting (00=Auto, 01=Digital, 02=Analog)			0199	00/01 Send/read the GPS (GSV) Sentence setting (00=OFF, 01=ON)
		0176	00/01 Send/read the Digital Repeater setting function setting (00=OFF, 01=ON)			0200	see p. 20-14 Send/read the GPS Message
		0177	00/01 Send/read the RX Call Sign Auto Write setting (00=OFF, 01=Auto)			0201	see p. 20-13 Send/read the Unproto Address
		0178	00/01 Send/read the RX RPT Call Sign Auto Write setting (00=OFF, 01=Auto)			0202	00/01 Send/read the position data extension setting (00=OFF, 01=COURSE/SPEED)
		0179	00/01 Send/read the DV Auto Detect setting (00=OFF, 01=ON)			0203	00 to 02 Send/read the GPS-A Time Stamp setting (00=OFF, 01=DHM, 02=HMS)
		0180	00/01 Send/read the RX Record (RPT) setting (00=ALL, 01=Latest Only)			0204	00/01 Send/read the GPS-A altitude setting (00=OFF, 01=ON)
		0181	00/01 Send/read the BK function setting (00=OFF, 01=ON)			0205	00 to 03 Send/read the GPS-A Symbol (00=No.1, 01=No.2, 02=No.3, 03=No.4)
0182	00/01 Send/read the EMR mode setting (00=OFF, 01=ON)	0206	see p. 20-13 Send/read the GPS-A Symbol No.1 setting				
0183	0000 to 0255 Send/read EMR AF Level (0000=0% to 0255=100%)	0207	see p. 20-13 Send/read the GPS-A Symbol No.2 setting				
0184	00 to 02 Send/read the external GPS receiver setting (00=OFF, 01=External GPS, 02=Manual)	0208	see p. 20-13 Send/read the GPS-A Symbol No.3 setting				
0185	00/01 Send/read the GPS Receiver Baud setting (00=4800 bps, 01=9600 bps)	0209	see p. 20-13 Send/read the GPS-A Symbol No.4 setting				
				0210	00 to 42 Send/read the GPS-A SSID (00=---, 01=(-(-), 02=-1 to 16=-15, 17=-A to 42=-Z)		

Remote jack (CI-V) information

◇ Command table (Continued)

Cmd.	Sub cmd.	Data	Description
1A	05	0211	see p. 20-14 Send/read the GPS-A comment
		0212	00 to 08 Send/read the GPS Auto TX interval setting (00=OFF, 01=5 sec., 02=10 sec., 03=30 sec., 04=1 min., 05=3 min., 06=5 min., 07=10 min., 08=30 min.)
		0213	00/01 Send/read the QSO Log setting (00=OFF, 01=ON)
		0214	00/01 Send/read the RX History Log function setting (00=OFF, 01=ON)
		0215	00 to 02 Send/read the QSO/RX Log CSV format setting (Separator/Decimal) (00=Separator is “,” and Decimal is “.”, 01=Separator is “,” and Decimal is “.”, 02=Separator is “;” and Decimal is “.”)
		0216	00 to 02 Send/read the QSO/RX Log CSV format setting (Date) (00=“yyyy/mm/dd”, 01=“mm/dd/yyyy”, 02=“dd/mm/yyyy”)
		0217	00/01 Send/read the Weather Alert setting (USA only) (00=OFF, 01=ON)
		0218	00 to 02 Send/read the Memory Name Display setting [System language: English] (00=OFF, 01=ON) [System language: Japanese] (00=OFF, 01=Normal, 02=Large)
		0219	00/01 Send/read the Display Type setting for the DR mode (00=Normal, 01=Large)
		0220	00 to 02 Send/read the Compass Direction setting (00=Heading Up, 01=North Up, 02=South Up)
	06	see p. 20-14	Send/read the DATA mode setting
1B	00	see p. 20-14	Send/read the Repeater tone frequency
		01	see p. 20-14 Send/read the Tone squelch frequency
		02	see p. 20-14 Send/read the DTCS code and polarity
		07	see p. 20-14 Send/read the CSQL code (DV mode)
1C	00	00	Send/read the Transceiver's status (RX)
		01	Send/read the Transceiver's status (TX)
	01	00	Send/read Antenna tuner OFF (through)
		01	Send/read Antenna tuner ON
		02	Send/read the Manual tuning selection
	02	00	Send/read Transmit frequency monitor check OFF
01		Send/read Transmit frequency monitor check ON	

Cmd.	Sub cmd.	Data	Description	
1E	00		Read number of available TX frequency band	
		01	see p. 20-12 Read the TX band edge frequencies	
1E	02		Read number of User-set TX frequency band	
		03	see p. 20-12 Send/read the User-set TX band edge frequencies	
1F	00	see p. 20-14	Send/read the DV MY call sign	
		01	see p. 20-14 Send/read the DV TX call signs	
		02	see p. 20-14 Send/read the DV TX message	
20	00	00	00/01* <sup>3</sup> Send/read the Auto DV RX Call signs output setting (00=OFF, 01=ON)	
			01	see p. 20-15 Output the DV RX Call signs
		01	00	00/01* <sup>3</sup> Send/read the Auto DV RX message output setting (00=OFF, 01=ON)
				01
	02	00	00/01* <sup>3</sup> Send/read the Auto DV RX status output setting (00=OFF, 01=ON)	
			01	see p. 20-15 Output the DV RX status
		01	00	00/01* <sup>3</sup> Send/read the Auto DV RX status output setting (00=OFF, 01=ON)
				01

\*<sup>3</sup> Output setting is automatically turned OFF after turning the power OFF, then ON.

Remote jack (CI-V) information (Continued)

◇ Data content description

• Operating frequency

Command: 00, 03, 05

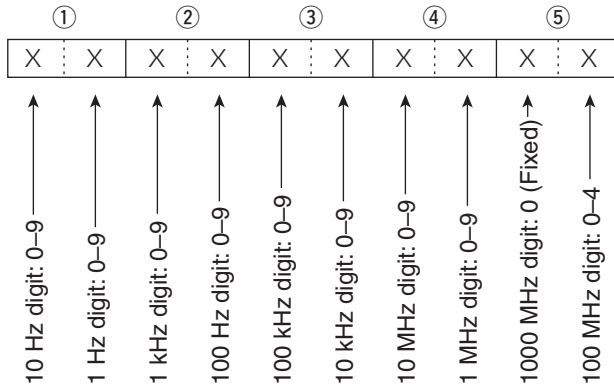

• RX HPF and LPF settings in each operating mode

Command: 1A 05 0056, 0059, 0062, 0065

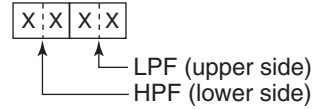

HPF  
00: through  
01 to 20: 100 to 2000 Hz

LPF  
05 to 24: 500 to 2400 Hz  
25: through

Set the LPF value larger than HPF one.

• Operating mode

Command: 01, 04, 06

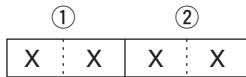

① Operating mode		② Filter setting
00: LSB	05: FM	01: FIL1
01: USB	06: WFM	02: FIL2
02: AM	07: CW-R	03: FIL3
03: CW	08: RTTY-R	—
04: RTTY	17: DV	—

• Filter setting (②) can be skipped with command 01 and 06. In that case, “FIL1” is automatically selected with command 01, and the default filter setting of the operating mode is automatically selected with command 06.

• When the WFM mode is selected with command 06, “FIL1” is automatically selected with command 01.

• CW message contents

Command : 17

Set a CW message of up to 30 characters.

• Character's code

Character	ASCII code	Description
0-9	30-39	Number
A-Z	41-5A	Alphabetical characters
a-z	61-7A	Alphabetical characters
space	20	Word space
/	2F	Symbol
?	3F	Symbol
.	2E	Symbol
-	2D	Symbol
,	2C	Symbol
:	3A	Symbol
'	27	Symbol
(	28	Symbol
)	29	Symbol
=	3D	Symbol
+	2B	Symbol
”	22	Symbol
@	40	Symbol

• SSB transmission **bandwidth** setting

Command: 1A 05 0074, 0075, 0076

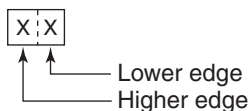

Lower edge	Higher edge
0: 100Hz	0: 2500Hz
1: 200Hz	1: 2700Hz
2: 300Hz	2: 2800Hz
3: 500Hz	3: 2900Hz

• “FF” stops sending CW messages.

• “^” is used to transmit a string of characters with no inter-character space.

Remote jack (CI-V) information

◇ Data content description (Continued)

• Character code setting

Command: 1A 00, 1A 05 0200, 1A 05 0201,  
1A 05 0206, 1A 05 0207, 1A 05 0208,  
1A 05 0209, 1A 05 0211, 1F 02, 20 0001,  
20 0002

Character	ASCII code	Character	ASCII code
A-Z	41-5A	a-z	61-7A
0-9	30-39	Space	20
!	21	#	23
\$	24	%	25
&	26	\	5C
?	3F	"	22
,	27	`	60
^	5E	+	2B
-	2D	*	2A
/	2F	.	2E
,	2C	:	3A
;	3B	=	3D
<	3C	>	3E
(	28	)	29
[	5B	]	5D
{	7B	}	7D
!	7C	_	5F
'	7E	@	40

• Band edge frequency setting

Command 02\*, 1E 01, 1E 03

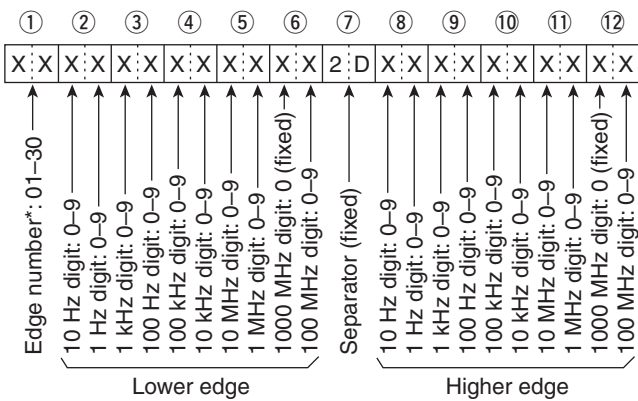

\* Edge number (①) is not sent with command 02 (reading the band edge frequencies).

• Band stacking register

Command : 1A 01

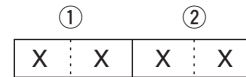

When sending the contents, the codes, such as operating frequency and operating mode\*, should be added after the frequency band code and register code, as shown below.

\*See ⑤ to ⑤ on 'Memory content setting.' (p. 20-16)

① Frequency band code

Code	Freq. band	Frequency range (unit: MHz)
01	1.8	1.800000- 1.999999
02	3.5	3.400000- 4.099999
03	7	6.900000- 7.499999
04	10	9.900000-10.499999
05	14	13.900000-14.499999
06	18	17.900000-18.499999
07	21	20.900000-21.499999
08	24	24.400000-25.099999
09	28	28.000000-29.999999
10	50	50.000000-54.000000
11	144	144.000000-148.000000
12	430	420.000000-450.000000
13	GENE	Other than above

② Register code

Code	Registered No.
01	1 (latest)
02	2
03	3 (oldest)

To read the contents, the register code should be added after the frequency band code, as shown below.

Example: When reading the oldest contents in the 21 MHz band, the code "0703" is used.

Remote jack (CI-V) information

◇ Data content description (Continued)

• Memory keyer contents

Command: 1A 02

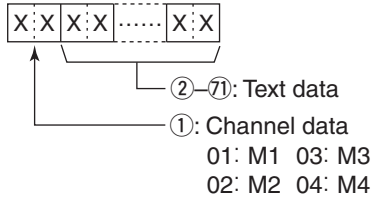

• Character's code

Character	ASCII code	Description
0-9	30-39	Number
A-Z	41-5A	Alphabetical characters
a-z	61-7A	Alphabetical characters
space	20	Word space
/	2F	Symbol
?	3F	Symbol
,	2C	Symbol
.	2E	Symbol
@	40	Symbol
^	5E	e.g., to send BT, enter ^BT
*	2A	Inserts contest number (can be used for 1 channel only)

• Split offset frequency setting

Command: 1A 05 0016

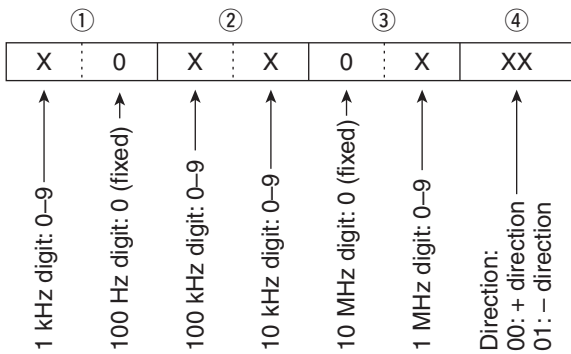

• Duplex Offset frequency setting

Command: 1A 05 0018

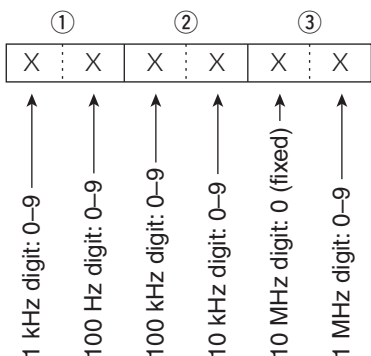

• UTC Offset setting

Command: 1A 05 0123

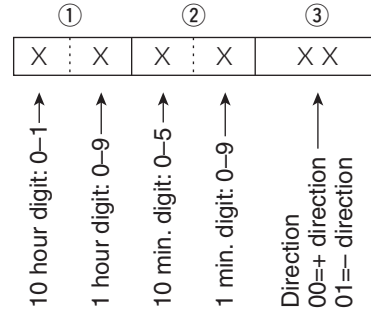

• My position data setting

Command: 1A 05 0186

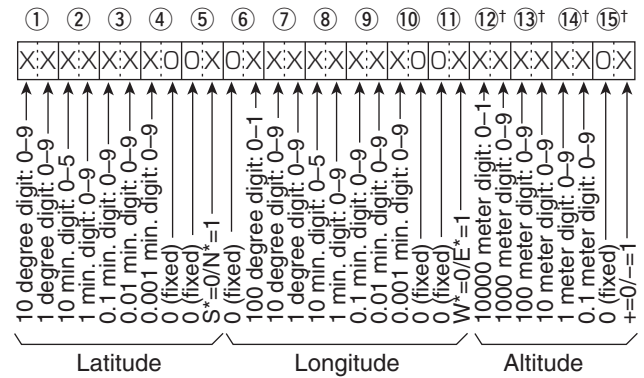

\*S: South latitude N: North latitude  
W: West longitude E: East longitude

† When reading the contents with no altitude, sends ⑫, ⑬, ⑭ and ⑮ as "FF"  
When sending the contents with no altitude, set ⑫, ⑬, ⑭ and ⑮ to "FF"

• Alarm area (Group) setting

Command: 1A 05 0191

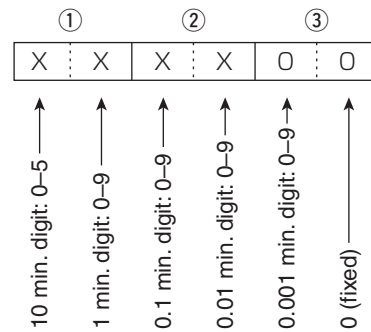

• Unproto Address setting

Command: 1A 05 0201

Set an unproto address of up to 56 characters.  
See 'Character code setting.' (p. 20-12)

Remote jack (CI-V) information

◇ Data content description (Continued)

• **GPS-A Symbol setting**

Command : 1A 05 0206, 0207, 0208, 0209

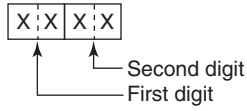

/, \, 0 to 9, A to Z can be used for the first digit character.

See 'Character code setting' for the second digit character. (p. 20-12)

• **Comment setting**

Command: 1A 05 0211

Set a comment of up to 43 characters.

See 'Character code setting.' (p. 20-12)

• **GPS message setting**

Command: 1A 05 0200

Set a GPS message of up to 20 characters.

See 'Character code setting.' (p. 20-12)

• **Data mode with filter width setting**

Command: 1A 06

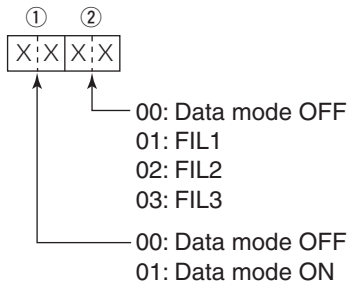

• **Repeater tone/tone squelch frequency setting**

Command: 1B 00, 1B 01

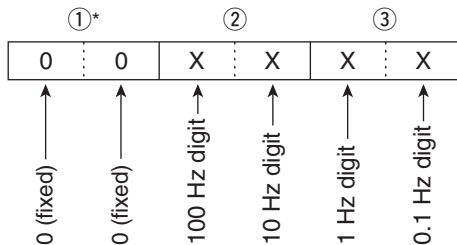

\*Not necessary when setting a frequency.

• **DTCS code and polarity setting**

Command: 1B 02

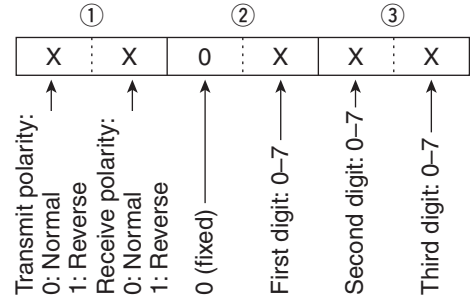

• **Digital code squelch setting**

Command: 1B 07

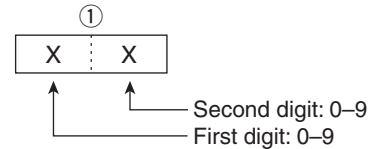

• **DV MY call sign setting**

Command: 1F 00

Set your own call sign and note of up to 12 characters.



①-⑧ Your own call sign setting

⑨-⑫ Note setting

• **DV TX call signs setting**

Command: 1F 01

Set "UR," "R1" and "R2" call signs of 8 characters (fixed).

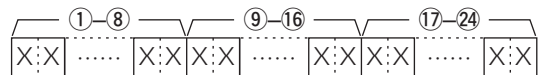

①-⑧ UR (Destination) call sign setting

⑨-⑯ R1 (Access repeater) call sign setting

⑰-⑳ R2 (Gateway/Link repeater) call sign setting

• Character's code of the call sign

Character	ASCII code	Character	ASCII code
0-9	30-39	A-Z	41-5A
Space	20	/	2F

• **DV TX message setting**

Command: 1F 02

Set the transmit message of up to 20 characters.

See 'Character code setting.' (p. 20-12)

⚡ "FF" stops sending or reading messages.

Remote jack (CI-V) information

◇ Data content description (Continued)

• DV RX call sign setting

Command : 20 0001, 20 0002

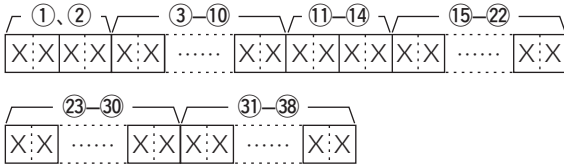

① Header flag data (First byte)

Data		Description
Bit		
7	0 (fixed)	—
6	0 (fixed)	—
5	0 (fixed)	—
4	0/1	0= Voice, 1= Data
3	0/1	0= Direct, 1= Through repeater
2	0/1	0= No Break-in, 1= Break-in
1	0/1	0= Data, 1= Control
0	0/1	0= Normal, 1= Emergency

② Header flag data (Second byte)

Data			Function
Bit 2	Bit 1	Bit 0	
1	1	1	Repeater control
1	1	0	Send auto acknowledge
1	0	1	(Not used)
1	0	0	Request to re-transmit
0	1	1	Send acknowledge
0	1	0	Receive no reply
0	0	1	Repeater disabled
0	0	0	NULL

- ③-⑩ Caller station's call sign (8 characters; fixed)
- ⑪-⑭ Caller station's note (4 characters; fixed)
- ⑮-⑲ Called station's call sign (8 characters; fixed)
- ⑳-⑳ Access repeater's call sign (R1) (8 characters)
- ㉑-㉓ Gateway/Link repeater's call sign (R2) (8 characters; fixed)

See 'Character code setting.' (p. 20-12)

⚡ "FF" stands for no call sign receiving after turning ON the transceiver.

• DV RX message setting

Command: 20 0101, 20 0102

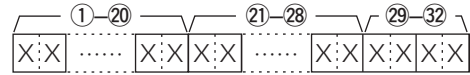

- ①-⑳ RX message (20 characters; fixed)
- ㉑-㉓ Call sign of the calling station (8 characters; fixed)
- ㉔-㉖ Note of the calling station (4 characters; fixed)

See 'Character code setting.' (p. 20-12)

⚡ "FF" stands for no message receiving after turning ON the transceiver.

• DV RX Status setting

Command: 20 0201, 20 0202

Data		Status	Description
Bit			
7	0	—	—
6	0/1	Receiving a voice call	During receiving a digital voice signal, select "1." (Regardless of DSQ1 and CSQ1 setting)
5	0/1	Last call finisher	When the last call was finished by you, select "1."
4	0/1	Receiving a signal	When the audio tone can be heard, select "1."
3	0/1	Receiving a BK call	During receiving a BK call, select "1."
2	0/1	Receiving a EMR call	During receiving a EMR call, select "1."
1	0/1	Receiving a signal other than DV	When "DV" and "FM" are blinking, select "1."
0	0/1	Packet loss status	During displaying a packet loss



Remote jack (CI-V) information

◇ Data content description (Continued)

• Memory content setting

Command: 1A 00

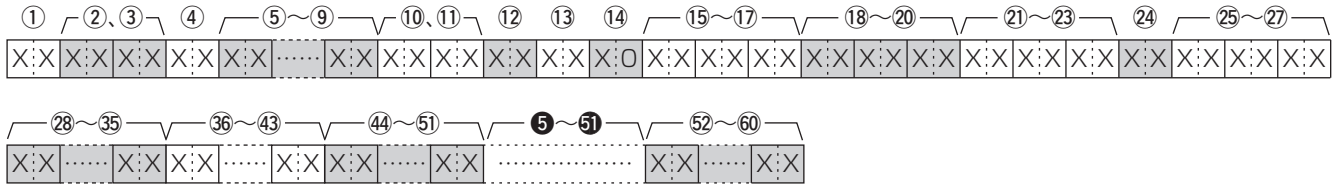

① Bank number

01: A, 02: B, 03: C, 04: D, 05: E

②, ③ Memory channel number

0001–0099: Memory channel 1 to 99

- 0100: Programmed scan edge 1A
- 0101: Programmed scan edge 1b
- 0102: Programmed scan edge 2A
- 0103: Programmed scan edge 2b
- 0104: Programmed scan edge 3A
- 0105: Programmed scan edge 3b
- 0106: Call channel 144-C1
- 0107: Call channel 144-C2
- 0108: Call channel 430-C1
- 0109: Call channel 430-C2

④ Split and Select memory settings

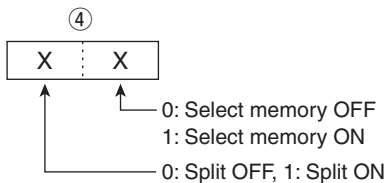

When the program channel is selected, both settings should be “0.”

When the Call channel is selected, the Select memory setting should be “0.”

⑤–⑨ Operating frequency setting

See ‘Operating frequency.’ (p. 20-11)

⑩, ⑪ Operating mode setting

See ‘Operating mode.’ (p. 20-11)

⑫ Data mode setting

1 byte data (XX)

00: Data mode OFF

01: Data mode ON

⑬ Duplex and Tone settings

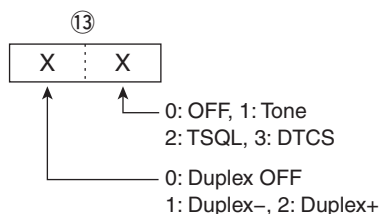

⑭ Digital squelch setting

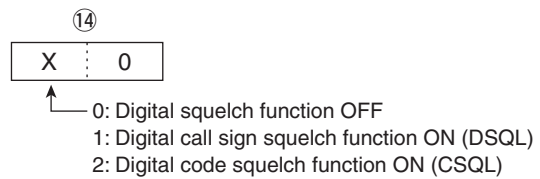

⑮–⑰ Repeater tone frequency setting

⑱–⑳ Tone squelch frequency setting

See ‘Repeater tone/tone squelch frequency setting.’ (p. 20-14)

㉑–㉓ DTCS code setting

See ‘DTCS code and polarity setting.’ (p. 20-14)

㉔ Digital code squelch setting

See ‘Digital code squelch setting.’ (p. 20-14)

㉕–㉗ Duplex offset frequency setting

See ‘Duplex Offset frequency setting.’ (p. 20-13)

㉘–㉙ Destination call sign setting (8 characters; fixed)

㉚–㉛ R1 (Access repeater) call sign setting (8 characters; fixed)

㉜–㉝ R2 (Gateway/Link repeater) call sign setting (8 characters; fixed)

See ‘DV TX call signs setting.’ (p. 20-14)

㉞–㉟ Memory name setting

16 characters (Fixed)

See ‘Character code setting.’ (p. 20-12)

**About clearing operation:**

“1A 00” command with the format as below clears the data of the selected memory channel.

②, ③ : Memory channel 0 to 99

④ : FF

⑤ or later : None

**NOTE:**

- The same data as ⑤–⑤① are stored in ⑤–⑤①.
- When the Split function is ON, the data of ⑤–⑤① is used for transmit.
- Even if the Split function is OFF, enter the data into ⑤–⑤① to match your transceiver. We recommend that you set the same data as ⑤–⑤①.

# Section 21 SPECIFICATIONS AND OPTIONS

---

<b>Specifications .....</b>	<b>21-2</b>
◇ General.....	21-2
◇ Transmitter.....	21-2
◇ Receiver .....	21-3
<b>Options .....</b>	<b>21-4</b>

## Specifications

### ◇ General

- Frequency coverage: (unit: MHz)
    - Receive
      - 0.030000–199.999999<sup>\*1\*2</sup>
      - 400.000000–470.000000<sup>\*1\*2</sup>
    - Transmit
      - 1.800000– 1.999999<sup>\*2</sup>, 3.500000– 3.999999<sup>\*2</sup>,
      - 5.255000– 5.405000<sup>\*1\*3</sup>,
      - 5.332000<sup>\*3\*4</sup>, 5.348000<sup>\*3\*4</sup>, 5.358500<sup>\*3\*4</sup>,
      - 5.373000<sup>\*3\*4</sup>, 5.405000<sup>\*3\*4</sup>,
      - 7.000000– 7.300000<sup>\*2</sup>, 10.100000– 10.150000<sup>\*2</sup>,
      - 14.000000– 14.350000<sup>\*2</sup>, 18.068000– 18.168000<sup>\*2</sup>,
      - 21.000000– 21.450000<sup>\*2</sup>, 24.890000– 24.990000<sup>\*2</sup>,
      - 28.000000– 29.700000<sup>\*2</sup>, 50.000000– 54.000000<sup>\*2</sup>,
      - 70.000000– 70.500000<sup>\*2</sup>, 144.000000–148.000000<sup>\*2</sup>,
      - 430.000000–450.000000<sup>\*2</sup>
  - <sup>\*1</sup>Some frequency ranges are not guaranteed.
  - <sup>\*2</sup>Depending on version. <sup>\*3</sup>USA version only.
  - <sup>\*4</sup>Center frequency.
- Mode: USB, LSB, CW, RTTY, AM, FM, WFM (RX only), DV
  - No. of memory channels: 495CH (99CH × 5 **bank**)
  - No. of scan edge memory channels: 6 CH (2 × 3 edges)
  - No. of call channels: 4 CH (2 × 2 **band**)
  - Antenna connector: SO-239 × 2
  - Antenna impedance: 50 Ω
  - Usable temperature range:
    - 10°C to +60°C;
    - +14°F to +140°F
  - Frequency stability: Less than ±0.5 ppm, 5 minutes after power ON. (0°C to +50°C; +32°F to +122°F at 430 MHz band)
  - Frequency resolution: 1 Hz
  - Power supply: 13.8 V DC ±15% (negative ground)
  - Power consumption:
    - Transmit
      - Max. power: 22.0 A
    - Receive
      - Standby: 0.9 A
      - Max. audio: 1.2 A
  - Dimensions (projections not included):
    - Main unit: 167(W) × 58(H) × 225(D) mm; 6.6(W) × 2.3(H) × 8.9(D) in
    - Controller: 165(W) × 64(H) × 78.5(D) mm; 6.5(W) × 2.5(H) × 3.1(D) in
  - Weight (approximately):
    - Main unit: 2.3 kg; 5.1 lb
    - Controller: 0.5 kg; 1.1 lb
  - ACC connector: 13-pin
  - DATA1 connector: 3-conductor 2.5 (d) mm (1/10")
  - DATA2 connector: 6-pin
  - REMOTE connector: 2-conductor 3.5 (d) mm (1/8")

### ◇ Transmitter

- Output power (at 13.8 V DC/+25°C): (continuously adjustable)

Frequency band	Output power
HF/50 MHz	2 to 100 W (AM: 1 to 30 W)*
70 MHz	2 to 50 W (AM: 1 to 15 W)*
144 MHz	2 to 50 W
430 MHz	2 to 35 W

\* In the AM mode, transmission can be performed only on the HF/50/70 MHz frequency band.

- Modulation system:
  - SSB: Digital PSN modulation
  - AM: Digital Low power modulation
  - FM: Digital Phase modulation
  - DV: GMSK Digital Phase modulation
- Spurious emission:
  - (Spurious domain)
    - HF bands: Less than –50 dB
    - 50 MHz band: Less than –63 dB
    - 70/144/430 MHz bands: Less than –60 dB
  - (Out-of-band domain)
    - HF bands: Less than –40 dB
    - 50/70/144/430 MHz bands: Less than –60 dB
- **Carrier** suppression: More than 50 dB
- Unwanted sideband suppression: More than 50 dB
- Microphone connector: 8-pin modular jack
- Microphone impedance: 600 Ω
- ELEC-KEY connector: 3-conductor 3.5(d) mm (1/8")
- KEY connector: 2-conductor 3.5(d) mm (1/8")

## Specifications (Continued)

### ◆ Receiver

- Receive system  
SSB/CW/RTTY/AM/FM/DV:  
Triple superheterodyne system  
WFM: Double superheterodyne system
- Intermediate frequencies  
1st: 124.487 MHz  
(SSB/CW/RTTY/AM/FM/DV)  
134.732 MHz (WFM)  
2nd: 455 kHz  
(SSB/CW/RTTY/AM/FM/DV)  
10.7 MHz (WFM)  
3rd: 36 kHz  
(SSB/CW/RTTY/AM/FM/DV)
- **Sensitivity**  
SSB, CW (10 dB S/N): 0.15 μV (1.80–29.9950 MHz)<sup>\*1</sup>  
0.12 μV (50 MHz)<sup>\*2</sup>  
0.15 μV (70 MHz)<sup>\*2</sup>  
0.11 μV (144/430 MHz)<sup>\*3</sup>  
AM (10 dB S/N): 13.0 μV (0.5–1.8 MHz)<sup>\*1</sup>  
2.0 μV (1.80–29.9950 MHz)<sup>\*1</sup>  
1.0 μV (50/70 MHz)<sup>\*2</sup>  
1.0 μV (144/430 MHz)  
FM (12 dB SINAD): 0.5 μV (28.0–29.7 MHz)<sup>\*1</sup>  
0.25 μV (50/70 MHz)<sup>\*2</sup>  
0.18 μV (144/430 MHz)<sup>\*3</sup>  
WFM (12 dB SINAD): 10.0 μV (76–108 MHz)<sup>\*3</sup>  
DV (1% BER): 1.0 μV (28.0–29.7 MHz)<sup>\*1</sup>  
0.63 μV (50/70 MHz)<sup>\*2</sup>  
0.35 μV (144/430 MHz)<sup>\*3</sup>

\*1 Preamp 1 is ON, \*2 Preamp 2 is ON, \*3 Preamp is ON

### • Squelch sensitivity

Frequency band	Squelch sensitivity
HF <sup>*1</sup>	SSB : Less than 5.6 μV
	FM : Less than 0.3 μV
50/70 MHz <sup>*2</sup>	SSB : Less than 5.6 μV
	FM : Less than 0.3 μV
144/430 MHz <sup>*3</sup>	SSB : Less than 5.6 μV
	FM : Less than 0.3 μV

\*1 Preamp 1 is ON, \*2 Preamp 2 is ON, \*3 Preamp is ON

- Selectivity (IF **filter** shape is set to SHARP.)  
SSB (BW: 2.4 kHz): More than 2.4 kHz/–6 dB  
Less than 3.4 kHz/–40 dB  
CW (BW: 500 Hz): More than 500 Hz/–6 dB  
Less than 700 Hz/–40 dB  
RTTY (BW: 500 Hz): More than 500 Hz/–6 dB  
Less than 800 Hz/–40 dB  
AM (BW: 6 kHz): More than 6.0 kHz/–6 dB  
Less than 10.0 kHz/–40 dB  
FM (BW: 15 kHz): More than 12.0 kHz/–6 dB  
Less than 22.0 kHz/–40 dB  
DV (CH space: 12.5 kHz): More than –50 dB

- Spurious and image rejection ratio  
HF band: More than 70 dB  
50/70 MHz bands\*: More than 70 dB  
\*except 1/2 IF through on 50/70 MHz bands  
144/430 MHz bands\*: More than 65 dB  
\*except IF through on 144 MHz band
- AF output power: More than 2.0 W at 10% distortion with an 8 Ω load
- AF output impedance: 8 Ω
- RIT variable range: ±9.999 kHz
- PHONES connector: 3-conductor 3.5 (d) mm (1/8")
- External SP connector: 2-conductor 3.5 (d) mm (1/8")/8 Ω
- **DSP ANF** attenuation: More than 30 dB (with 1 kHz single tone)
- DSP MNF attenuation: More than 70 dB
- DSP **NR** attenuation: More than 6 dB (noise rejection in SSB)

## Options

### AT-180 HF/50 MHz AUTOMATIC ANTENNA TUNER



Fully automatic antenna tuner with pre-set memories for each 100 kHz. Unique “automatic tuner on” function is available. See page 16-3 for AT-180 specifications.

### AH-4 HF AUTOMATIC ANTENNA TUNER



Specially designed to tune a long wire antenna for portable or mobile HF/50 MHz operation. The “PTT tune” function provides simple operation.

- Input power rating: 120 W

### AH-2b ANTENNA ELEMENT



A 2.5 m long antenna element for mobile operation with the AH-4.

- Frequency coverage 7–54 MHz band with the AH-4

### PS-126 DC POWER SUPPLY



- Output voltage : 13.8 V DC
- Max. output current : 25 A

### SM-30 DESKTOP MICROPHONE



Includes a low frequency cut function. An optional OPC-599 is required for connection.

### SM-50 DESKTOP MICROPHONE



Unidirectional, dynamic microphone for base station operation. Includes [UP]/[DOWN] switches, a low cut switch and mic gain control. An optional OPC-589 is required for connection.

### HM-36 HAND MICROPHONE



Hand microphone equipped with [UP]/[DOWN] switches. An optional OPC-599 is required for connection.

### CT-17 C-I-V LEVEL CONVERTER UNIT



For remote transceiver control using a personal computer equipped with an RS-232C port. You can change frequencies, operating mode, memory channels, and so on with your computer.

### SP-35 EXTERNAL SPEAKER



External speakers suitable for mobile operation.  
SP-35: Compact-type; 4 Ω/7 W

### Options (Continued)

#### IC-PW1/EURO HF/50 MHZ ALL BAND 1 KW LINEAR AMPLIFIER



Full-duty 1 kW linear amplifier including an automatic antenna tuner. Has automatic tuning and band selection capability. Full break-in (QSK) operation is possible. The amplifier/power supply unit and the remote control unit are separated. An optional OPC-599 is required for connection.

#### MBF-1 MOUNTING BASE



Allows you to conveniently vehicle-mount the Controller. An MBA-1 must be used in combination with the MBF-1.

- **HM-103 HAND MICROPHONE**

Hand microphone equipped with [UP]/[DOWN] switches.

- **HM-151 HAND MICROPHONE**

Remote control microphone.

- **HM-198 HAND MICROPHONE**

Hand microphone equipped with [UP]/[DOWN] switches. The same as that supplied with the transceiver.

- **MB-62 MOBILE MOUNTING BRACKET**

Mounts the transceiver Main unit or the AT-180 inside a vehicle.

- **MBA-1 MOUNTING BRACKET**

Metal plate for attaching the Controller to an MBF-1, wall or other such flat surface.

- **OPC-420 SHIELDED CONTROL CABLE**

The shielded control cable protects the transceiver from RF feedback and extends the separation between the AH-4 and the transceiver up to 10 meters (32.8 feet).

- **OPC-589 MICROPHONE ADAPTER CABLE**

Conversion between 8-pin modular and 8-pin metal connector for using a desktop microphone.

- **OPC-599 ADAPTER CABLE**

13-pin, ACC connector to 7-pin + 8-pin ACC connector.

- **OPC-742 ACC 13-PIN CABLE**

Required when using both of the AT-180 and 144/430MHz Linear amplifier.

- **OPC-1529R DATA COMMUNICATION CABLE (RS-232C type)**

Allows low-speed data communication in the DV mode, and receiving a GPS data from a third-party GPS receiver.

- **OPC-2218LU DATA COMMUNICATION CABLE (USB type)**

Allows low-speed data communication in the DV mode.

- **OPC-2253 CONTROL CABLE**

OPC-2253: 3.5 m (11.5 ft) type,

OPC-2254: 5 m (16.4 ft) type

- **CS-7100 CLONING SOFTWARE**

Use this software to program settings, memory channels and set mode contents quickly and easily via your PC's USB port.

A USB cable is required. (A-Mini B type, supplied with the transceiver)

- **RS-BA1 IP REMOTE CONTROL SOFTWARE**

/// To remotely control radios using the RS-BA1, **BE SURE** that you comply with your local regulations.

Approved Icom optional equipment is designed for optimal performance when used with an Icom transceiver.

Icom is not responsible for the destruction or damage to an Icom transceiver in the event the Icom transceiver is used with equipment that is not manufactured or approved by Icom.

**Count on us!**

